



TOP[®] *Line*

D.S.R.A.V.

AMMORTIZZATORI - shock absorbers - amortisseurs
stossdämpfer amortecedores - amortiguadores

Catalogue
edition **15**

OIL - GAS



- Sospensione MacPherson

- Complete MacPherson strut
- MacPherson komplettes Federbein
- Coluna de Suspensão MacPherson
- Komplet fjederben

- Jambe de force type MacPherson
- Columna de suspension
- Complete MacPherson veerpoet
- Подвеска Макферсона



- Ammortizzatore con piattello portamolla

- Shock absorber with spring seat
- Stossdämpfer mit Federsitzteller
- Amortecedor com Base para Mola
- Støddæmper med fjeder skål

- Amortisseur à siège de ressort
- Amortiguador con asiento para muelle
- Schokdemper met veerschotel
- Амортизатор с площадкой для установки пружины



- Cartuccia di ricambio MacPherson

- MacPherson insert
- MacPherson Federbeinsatz
- Cartucho Substituição para Coluna Suspensão MacPherson
- Indsats

- Cartouche type Mac Pherson
- Cartucho accesorio para columna de suspensión
- MacPherson patroon
- Заменяемый вкладыш стойки Макферсона

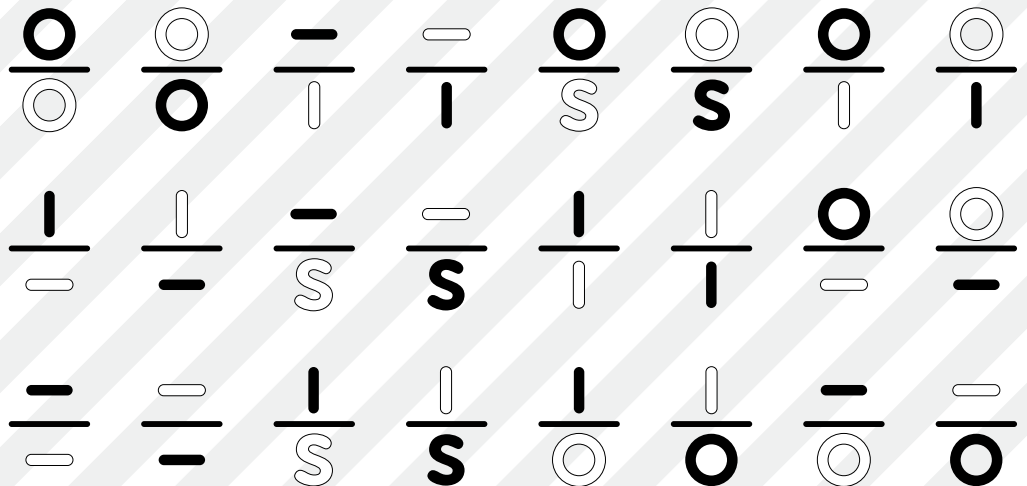

- Tipo di applicazione

- Application type
- Anwendung der Stossdämpfer
- Esquema de Montagem
- Anvendelse

- Type de application

- Esquema de anclajes
- Bevestiging van de schokdemper
- Вид применения



- Tempo di montaggio (min) per asse

- Assembly time (min.) for the axle
- Montagezeit (Min.) jeder Achse
- Tempo de Montagem (Min.) por Eixo
- Monterings tid (min) per aksel
- Temps de montage (min.) pour axe
- Tiempo de montaje (Min.) para eje
- Werktijd (Min.) per as
- Время монтажа (минут) на мост



D.S.R.A.V.

TOP *Line* ®

ALFEO MORET
S.p.A.



Presente sul mercato da oltre 40 anni, **OSRAV** produce sistemi di sospensione per autoveicoli, secondo specifiche di qualità ormai consolidate ISO. Forte di questa continua esperienza e competenza, grazie al personale altamente qualificato e motivato, studia e sviluppa la linea di **AMMORTIZZATORI TOP LINE** come soluzione ideale per ogni esigenza del mercato del ricambio.

L'evoluzione tecnologica ha fatto sì che la storica versione di ammortizzatori idraulici sia ormai sostituita dalla più evoluta applicazione mista olio/gas, mentre per i veicoli più datati la sospensione rinforzata è ancora la soluzione ottimale richiesta dal cliente perché meglio si adatta allo stato di usura del veicolo.

La nostra specializzazione e conoscenza del settore ci consente di trovare sempre soluzioni efficaci e durature alla maggior parte delle problematiche sollevate dalla clientela, rispondendo in tal modo alle più disparate richieste provenienti dal mercato, dettate da esigenze tecniche particolari o da problematiche legate ad assetti originali poco performanti o soggetti a prematura usura, il tutto con grande impegno, professionalità e flessibilità nei lotti di produzione.

L'utilizzo di specifiche attrezzature, la semplificazione dei processi produttivi e l'impiego di componenti ampiamente testati e sempre aggiornati nel disegno e nei materiali, ci consentono di certificare una garanzia di 2 anni sul prodotto.

Il nostro servizio tecnico post-vendita è costantemente a disposizione della clientela fidelizzata per fornire tutti i chiarimenti e le informazioni tecniche necessarie a supportare l'attività commerciale, nonché i suggerimenti più appropriati legati sia alla nostra lunga esperienza produttiva che alla sperimentazione pratica derivante dalle installazioni, test e collaudi fatte sui veicoli, consapevoli di rendere un servizio prezioso e di ricevere altresì delle notizie dirette dal mercato, che vengono a loro volta elaborate per essere rimesse nel circuito dell'informazione.

Un'ulteriore garanzia aggiuntiva per il cliente, che solo la nostra struttura (per l'obiettivo che si è prefissa) è in grado di poter erogare.

Infine una gamma sempre costantemente aggiornata nei modelli, rispetto al parco circolante, completa la nostra "mission".

TOP LINE, la migliore sintesi sul mercato per QUALITÀ/PREZZO e SERVIZIO.

Present in the market for over 40 years, **OSRAV** produces suspension systems for vehicles following ISO quality consolidated specifications.

Strong of this experience and competency, thanks to the highly qualified and motivated staff, Osrav studies the **TOP LINE SHOCK ABSORBERS** line as ideal solution for every kind of aftermarket demand.

The technological evolution changed the historical hydraulic version of the shock absorbers in a new mixed application oil/gas, while the reinforced suspension of the oldest vehicles remain the optimal solution required from the customer because it better fit on the vehicle wear conditions.

Our specialization and sector knowledge allow us to find always more effective and lasting solutions of customer inquiries, responding in this way on all the different market inquiries, demands dictated by specific technical needs or problems related to low-performing original suspension or subject to a premature wear; all this with a big effort, professionalism and flexibility on the production lots.

The use of specific equipment, the simplification of production processes and the commitment of components extensively tested and always been updated on drawing and material, allow us to certify a guarantee of 2 years on the product.

Our technical post sales service is constantly at loyal customers disposal to give all the explanation and technical information necessary to support the business, as well as the most appropriate suggestions related to our long manufacturing experience and practical experimentation resulting from the installations and vehicle's test. We are aware of making a dear service and to receive also information directly from the market which will be elaborated to be utilized in information circuit.

A further guarantee for a customer which only our Company is able to do (for the aim Osrav has).

Finally our range always updating on the models following the circulating cars complete our "mission".

TOP LINE, our best synthesis on the market for QUALITY/PRICE and SERVICE.



FORTI DI NATURA

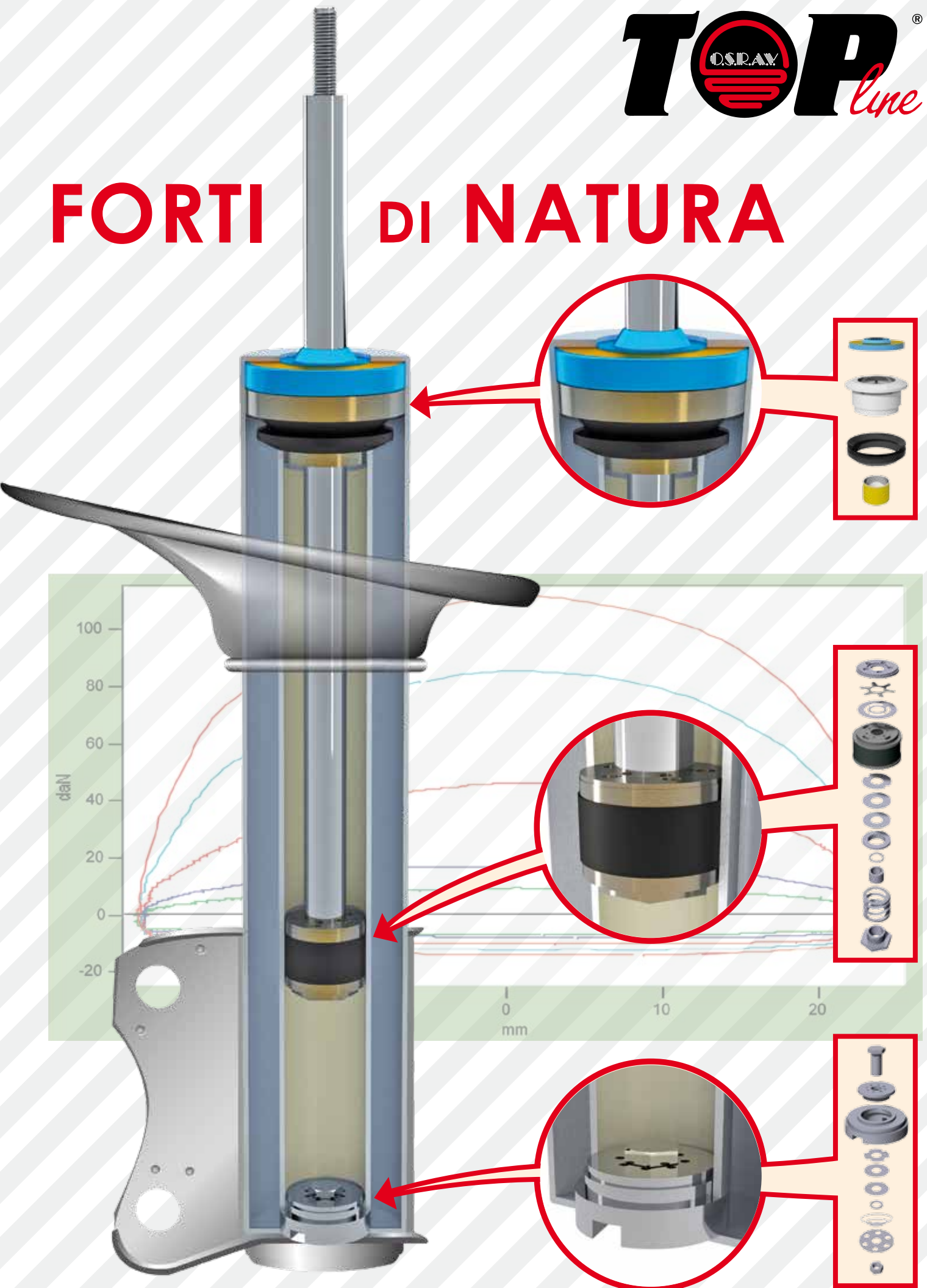

CONSULTAZIONE CATALOGO

pag. 1

How to look up in the catalogue - Consultation du catalogue - Nachschlage des Katalog - Consulta de catálogo - Consulta de Catálogo

Consultatie van de catalogus - Sådan slår du op i kataloget - Руководство пользователя

ALFA ROMEO	pag. 2	JAGUAR	pag. 67	SMART	pag. 135
ARO	pag. 6	JEEP	pag. 67	SSANG YONG	pag. 136
AUDI	pag. 6	KIA	pag. 68	SUBARU	pag. 136
AUSTIN	pag. 12	LADA	pag. 70	SUZUKI	pag. 138
AUTOBIANCHI	pag. 13	LANCIA	pag. 71	TALBOT	pag. 140
BARKAS	pag. 13	LAND ROVER	pag. 74	TOYOTA	pag. 142
BEDFORD	pag. 14	MAZDA	pag. 75	VAUXHALL	pag. 150
BMW	pag. 15	MERCEDES	pag. 79	VOLKSWAGEN	pag. 154
CHEVROLET	pag. 26	MINI	pag. 86	VOLVO	pag. 164
CHRYSLER	pag. 27	MITSUBISHI	pag. 86	ZASTAVA	pag. 168
CITROËN	pag. 28	NISSAN	pag. 91		
DACIA	pag. 34	OPEL	pag. 99		
DAEWOO - CHEVROLET	pag. 35	PEUGEOT	pag. 106		
DAIHATSU	pag. 36	PIAGGIO	pag. 114		
FIAT	pag. 37	POLSKI	pag. 114		
FORD	pag. 47	PORSCHE	pag. 114		
HONDA	pag. 58	RENAULT	pag. 115		
HYUNDAI	pag. 61	ROVER	pag. 126		
INNOCENTI	pag. 64	SAAB	pag. 127		
ISUZU	pag. 65	SEAT	pag. 129		
IVECO	pag. 65	SKODA	pag. 133		

CONDIZIONI GENERALI DI VENDITA

pag. 170

General sales term and conditions - Conditions générales de ventes - Allgemeine Verkaufsbedingungen - Condiciones generales de las ventas

Condições Gerais de Venda - Algemene verkoopcondities - Generale salgs konditioner - Основные условия продажи

PRINCIPALI CAUSE DI DANNEGGIAMENTO NON IMPUTABILI A DIFETTOSITÀ DEL PRODOTTO

pag. 172

Principle defects due to improper handling of product

ATTACCHI AMMORTIZZATORI

pag. 174

Shock absorbers end fitting - Type des fixations des amortisseurs - Befestigung der Stossdämpfer - Esquema de anclajes

Diagrama de Montagem de Amortecedores - Bevestigingstype van de schokdemper - Monterings vejledning - Крепления амортизаторов

LEGENDA

pag. 175

Legend - Legende - Bemerkung - Leyenda - Legenda - Legende - Bemærkning - Легенда

CONSULTAZIONE CATALOGO

How to look up in the catalogue - Consultation du catalogue - Nachschlage des Katalog - Consulta de catálogo
 Consulta de Catálogo - Consultatie van de catalogus - Sădan slår du op i kataloget. - Руководство пользователя



**ANTERIORE
FRONT**



**POSTERIORE
REAR**



OIL

GAS



OIL

GAS



BMW (D)

3 SERIES (E36) EXCL. M-TECHNIK

316i	06.92 - 02.98	←	<i>BMW364S</i>	BWC364S/GL	160		<i>BMW34P</i>	BWC34P/GL	60
318is	06.92 - 02.98	→	<i>BMW364D</i>	BWC364D/GL	160				
			5 ACC57						

Data

Date - Date
 Baujahr - Fecha
 Data - Bouwjaar
 Productions år - Дата

Marca/Costruttore

Manufacturer - Fabricant
 Hersteller - Marca/Constructor
 Fabricante - Merk
 Fabrikant - Производитель

Specifica Modello

Model specifications - Caractéristiques modèles
 Besonderheit - Especificación modelo
 Especificação modelo - Model-Specificaties
 Model Betegnelse - Объем двигателя

Modello Veicolo

Model - Modèle
 Modell - Modelo
 Modelo - Model
 Model - Модель

Note

Note - Notes
 Anmerkungen - Anotación
 Nota - Opmerkingen
 Bemærkning - примечания

Ammortizzatori idraulici

Hydraulic shock absorbers - Amortisseurs hydrauliques
 Hydraulische Stossdämpfer - Amortiguadores hidráulicos
 Amortecedores Hidráulicos - Hydraulische schokdempers
 Olie støddæmper - Гидравлические амортизаторы

Ammortizzatori a gas

Gas charged shock absorbers - Amortisseurs à Gaz
 Gasdruck Stossdämpfer - Amortiguadores de Gas
 Amortecedores a Gás - Gas-Schokdempers
 Gas støddæmper - Газовые амортизаторы

Tipo di applicazione

Application type - Type de application
 Anwendung der Stossdämpfer - Esquema de anclajes
 Esquema de Montagem - Bevestiging van de schokdemper
 Anvendelse - Вид применения

Tempo di montaggio (min) per asse

Assembly time (Min.) for the axle - Temps de montage (min.) pour axe
 Montagezeit (Min.) jeder Achse - Tiempo de montaje (Min.) para eje
 Tempo de Montagem (Min.) por Eixo - Werktijd (min) per as
 Monterings tid (min) per aksel - Время установки

LEGENDA CODICI - CODES

MR11P **Italico**

Codice ad esaurimento - Code available until stock depleted
 Référence disponible jus'q'à epuissement du stock - Solange Vorrat reicht
 Codigo disponible hasta agotar existencias - Artigo disponível até esgotar stock
 Leverbaar zolang de voorraad strekt - Leveres så længe lager haves - Код В ликвидации

MR11PGL **Italico sottolineato**

Codice Esaurito - Code sold out
 Référence épuisé - Artikel verbraucht
 Artículo Exhausto - Referencia terminado
 Code uf - Code ud - Код закончена

VITO I

excl. 	(638)	02.96 - 10.03		MR11A	<i>MR11A/GL</i>		N.D.	<i>MR11P</i>	<i>MR11PGL</i>	
							H.D.	MR112P	MR112P/GL	

MR11A **Grassetto**

Codice nuovo disponibile - New code available
 Nouvelle référence disponible - Neue Stossdämpfer vorhanden
 Nuevo código disponible - Nova Referência disponível
 Nieuw nummer leverbaar - Ny udviklede numre levering
 Новый код доступны

MR11A/GL **Grassetto sottolineato**

Codice nuovo non disponibile - New code not available
 Nouvelle référence pas disponible - Neue Stossdämpfer nicht vorhanden
 Nuevo código no disponible - Nova Referência no disponível
 Nieuw nummer niet leverbaar - Ny udviklede numre ikke levering
 Новый код не доступен

MR112P **Normale**

Codice Corrente - Current code
 Référence courante - Gebrauchsartikel
 Artículo corriente - Artigo atual huidige artikel
 Nuværende artikel
 активный код

MR112P/GL **Normale sottolineato**

Codice Corrente non disponibile
 Current code not available - Référence courante pas disponible
 Gebrauchsartikel nicht vorhanden - Artículo corriente no disponible
 Artigo atual no disponível - huidige artikel niet leverbaar
 Nuværende artikel ikke levering - активный код не доступен

OIL
GAS

OIL
GAS



ALFA ROMEO (I)

ALFA 6

2.0, 2.5 Turbo Diesel	(119)	04.79 - 12.86		ARO17A	ARO17A/GL	$\frac{1}{2}$	50			ARO09P/GL	$\frac{1}{6}$	50
-----------------------	-------	---------------	--	--------	-----------	---------------	----	--	--	-----------	---------------	----

ALFA 33

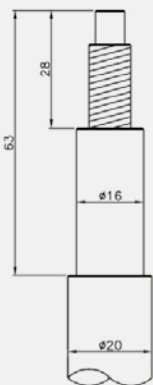
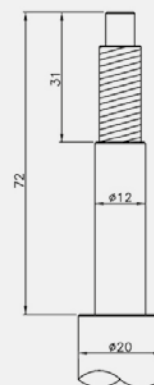
1.2, 1.3, 1.3 S, 1.5, 1.7 1.8 TD excl. 4X4	(905, 905A)	06.83 - 02.87 06.83 - 02.87	I ← → I Ⓢ ACC46		ARO22AS/GL ARO22AD/GL	 	85			ARO12P/GL	$\frac{1}{6}$	75
1.5 4X4	(905, 905A)	06.83 - 02.87	I ← → I		ARO14AS/GL ARO14AD/GL	 	85			ARO12P/GL	$\frac{1}{6}$	105
1.2, 1.3, 1.5, 1.7, 1.8 TD	(905, 905A)	03.87 - 01.90	I ← → I Ⓢ ACC46		ARO22AS/GL ARO22AD/GL	 	85			ARO12P/GL	$\frac{1}{6}$	75
1.3, 1.3 S, 1.4, 1.5, 1.7 excl. 1.7ie 16V, 4X4	(907A, 907B)	01.90 - 01.93 01.90 - 01.93	I ← → I Ⓢ ACC46		ARO27AS/GL ARO27AD/GL	 	85			ARO12P/GL	$\frac{1}{6}$	75
1.7ie 16V 4X2	(907A)	04.90 - 01.93	I ←									
1.7ie 16V SW 4X2	(907B)	04.90 - 01.93	→ I									
1.7ie 16V 4X4	(907A)	04.90 - 01.93	I ←							ARO12P/GL	$\frac{1}{6}$	75
1.7ie 16V SW 4X4	(907B)	04.90 - 01.93	→ I									
1.8 TD	(907A, 907B)	04.90 - 01.93	I ← → I			 				ARO12P/GL	$\frac{1}{6}$	75
1.3, 1.4, 1.5, 1.7 excl. 1.7ie 16V	(907A, 907B)	02.93 - 09.94	I ← → I ACC47		ARO31AS/GL ARO31AD/GL	 	90			ARO12P/GL	$\frac{1}{6}$	75
1.7ie 16V	(907A, 907B)	02.93 - 09.94	I ← → I ACC47		ARO31AS/GL ARO31AD/GL	 	90			ARO12P/GL	$\frac{1}{6}$	75

1
**ARO22AS/GL
ARO22AD/GL**

2
**ARO27AS/GL
ARO27AD/GL**

- 3**
- Ⓢ Il cuscinetto a rulli originale deve essere sostituito con un cuscinetto a sfere rif. 142040.
 - Ⓢ The original needle-bearing has to be replaced by bearing Nr. 142040.
 - Ⓢ Le roulement à aiguilles d'origine doit être remplacé par un roulement à billes réf. 142040.
 - Ⓢ Beim Einsatz von Federbeinen, muß das vorhandene Naddellager am Federbein durch ein Kugellager Nr. 142040 ersetzt werden.
 - Ⓢ El rodamiento de agujas debe sustituirse por el rodamiento nº 142040.
 - Ⓢ O rolamento de agulhas original tem que ser substituído por um rolamento ref. 142040.



		OIL	GAS				OIL	GAS		
--	--	------------	------------	--	--	--	------------	------------	--	--

ALFA ROMEO (I)

ALFA 75

	(162B)	06.85 - 02.92		AR015A	AR015A/GL		45		AR015P	AR015P/GL		45
--	--------	---------------	--	--------	-----------	--	----	--	--------	-----------	--	----

ALFA 90

	(162)	09.84 - 07.87		AR015A	AR015A/GL		45		AR015P	AR015P/GL		45
--	-------	---------------	--	--------	-----------	--	----	--	--------	-----------	--	----

ALFA 145

1.3, 1.6, 1.7 16V Boxer	(930)	03.95 - 12.96	 ACC48		AR033ASGL AR033ADVGL	 	90			FI071P/GL		55
1.4 16V T.S., 1.6 16V T.S. 1.8 16V T.S., 2.0 16V T.S.	(930)	12.96 - 01.01	ACC48		AR030A/GL		70			FI071P/GL		55
1.9 TDS	(930)	07.94 - 01.01	ACC48		AR030A/GL		70			FI071P/GL		55
1.9 JTD	(930)	02.99 - 01.01	ACC48		AR032A/GL		70			FI071P/GL		55

ALFA 146

1.3, 1.6, 1.7 16V Boxer	(930) (930)	03.95 - 12.96	 ACC48		AR033ASGL AR033ADVGL	 	90			FI071P/GL		55
1.4 16V T.S., 1.6 16V T.S. 1.8 16V T.S., 2.0 16V T.S.	(930) (930)	12.96 - 01.01	ACC48		AR030A/GL		70			FI071P/GL		55
1.9 TDS	(930)	07.94 - 01.01	ACC48		AR030A/GL		70			FI071P/GL		55
1.9 JTD	(930)	02.99 - 01.01	ACC48		AR032A/GL		70			FI071P/GL		55

ALFA 147

excl. 3.2 GTA	(937)	01.01 - 03.10			AR039A/GL		120			AR042P/GL		100
3.2 GTA	(937)	02.03 - 03.10			AR053A/GL		120			AR053P/GL		100

ALFA 155

1.6, 1.7, 1.9 TD, 2.0 TD excl.	(167)	01.92 - 12.97	ACC48		AR030A/GL		100			FI068P/GL		50
1.8 TS, 2.0 TS, excl.	(167)	01.92 - 12.97	ACC48		AR030A/GL		100			FI068P/GL		50
2.5 V6 excl.	(167)	01.92 - 12.97	ACC48		AR032A/GL		100			FI068P/GL		50
2.5 TD excl.	(167)	04.93 - 12.97	ACC48		AR032A/GL		100			FI068P/GL		50
2.0 Turbo 4x4 excl.	(167)	01.92 - 12.97	ACC48		AR032A/GL		100					50

ALFA 156

excl. → Ch. 0116245	(932)	09.97 - 10.98			AR038A/GL		100			AR038P/GL		80
excl. Ch. 0116246 →	(932)	10.98 - 09.05			AR038A/GL		100			AR042P/GL		80
 → Ch. 0116245	(932)	09.97 - 10.98			AR039A/GL		100					
 Ch. 0116246 →	(932)	10.98 - 09.05			AR039A/GL		100			AR039P/GL		80



OIL

GAS



OIL

GAS



ALFA ROMEO (I)

ALFA 156 SPORTWAGON

excl.	(932)	05.00 - 05.06			ARO38A/GL		100			ARO42P/GL		80
-------	-------	---------------	--	--	-----------	--	-----	--	--	-----------	--	----

ALFA 159

excl. , Q4	(140)	09.05 - 11.11			ARO45A/GL					ARO45P/GL		
Sportwagon excl. , Q4	(140)	03.06 - 11.11			ARO45A/GL					ARO45P/GL		

ALFA 164

2.0 TS, 2.0 Turbo, 3.0 V6, 2.5 TD excl. → Ch. 6183988	(164)	01.87 - 04.90		ACC47	ARO24A/GL		85	excl.		LN027P/GL		110
2.0 TS, 2.0 Turbo, 3.0 V6, 2.5 TD excl. Ch. 6183989 →	(164)	05.90 - 09.98		ACC47	ARO28A/GL		85	excl.		LN027P/GL		110

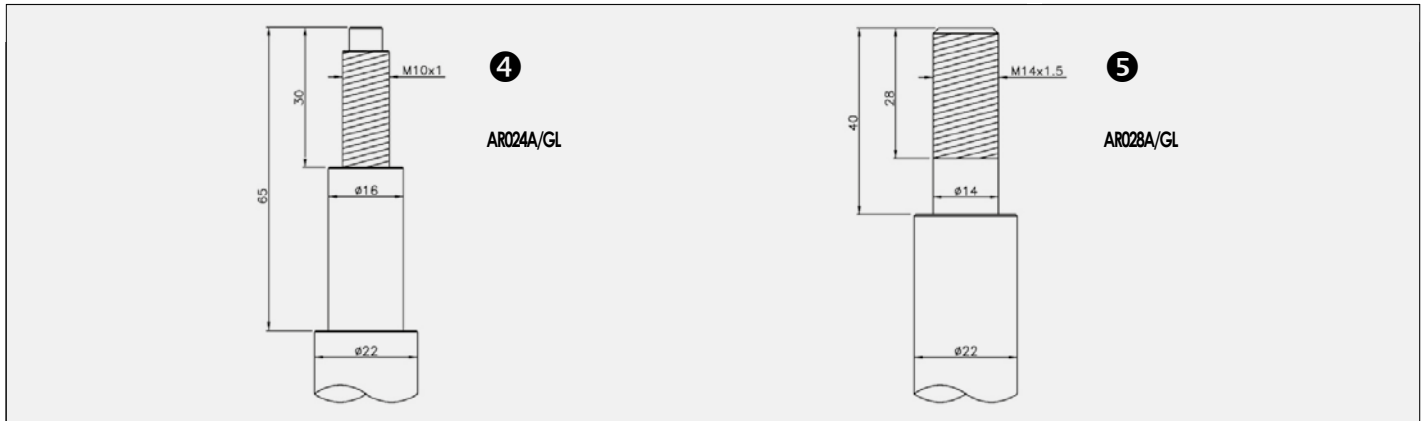

ALFA 166

	(936)	09.98 - 06.07			ARO40A/GL		80			ARO40P/GL		90
--	-------	---------------	--	--	-----------	--	----	--	--	-----------	--	----

ALFA 1750/2000

GT, GTV, Spider	(105)	03.68 - 07.75		ARO03A					ARO03P			
-----------------	-------	---------------	--	--------	--	--	--	--	--------	--	--	--

ALFA SUD

1.2, 1.3, 1.5Ti	(901)	06.72 - 12.84		ARO06A			100		ARO06P			40
Sprint	(902A)	09.76 - 03.82										
Sprint Veloce 1.3, 1.5Ti	(902A)	01.79 - 12.89										
Sprint, Sprint Ti Alfa 33 susp.	(902A)	01.84 - 12.89	 	ACC46	ARO22ASGL ARO22AD/GL		85			ARO12P/GL		75

ALFETTA

1.6, 1.8, 2.0, 2.0 TD	(116)	07.74 - 12.84		ARO17A	ARO17A/GL		45		ARO17P	ARO17P/GL		45
GTV 1.6, 1.8, 2.0, 2.0 Turbo, 2.5	(116)	1974 - 12.84										

ARNA

1.2, 1.3, 1.5	(920)	10.84 - 12.86	 	ACC46	ARO22ASGL ARO22AD/GL		85		ARO11P	ARO11P/GL		45
---------------	-------	---------------	--------------	-------	-------------------------	--	----	--	--------	-----------	--	----

ALFA ROMEO (I)

- 1 3**
- ① Vedi disegno/nota Alfa 33 a pagina 2
 - Ⓒ See drawing/note Alfa 33 on page 2
 - Ⓕ Voir plan/note Alfa 33 à la page 2
 - Ⓓ Siehe Alfa 33 Zeichnung/Anmerkung auf Seite 2
 - Ⓔ Ver dibujo/anotación Alfa 33 a la página 2
 - Ⓖ Ver figura/nota Alfa 33 na página 2

BRERA

excl. Q4	(177)	01.06 -			AR046A/GL					AR046P/GL		
excl. Q4	(177)	03.06 -										

CROSSWAGON

excl.		09.05 -			<u>AR047A/GL</u>					<u>AR047P/GL</u>		
		03.06 -			<u>AR048A/GL</u>					<u>AR048P/GL</u>		

GIULIA

	(105, 115)	06.64 - 12.78			AR003A			50		AR003P			50
--	------------	---------------	--	--	--------	--	--	----	--	--------	--	--	----

GIULIETTA

1.3, 1.6, 1.8, 2.0	(116)	10.77 - 12.85			AR017A	<u>AR017A/GL</u>		45		AR017P	<u>AR017P/GL</u>		45
2.0 TD		01.83 - 12.85											

GIULIETTA

	(940)	04.10 -			AR052AS/GL					AR052P/GL		
					AR052AD/GL							

GT

excl. 3.2 GTA	(937)	11.03 - 09.10			AR049A/GL			100		AR049P/GL			80
3.2 GTA	(937)	11.03 - 09.10			AR053A/GL			120		AR053P/GL			100

GTV

1.6, 1.8, 2.0, 2.0 Turbo, 2.5	(116)	07.74 - 12.84			AR017A	<u>AR017A/GL</u>		45		AR017P	<u>AR017P/GL</u>		45
2.0, 2.5	(116)	01.85 - 02.87			AR015A	<u>AR015A/GL</u>		45		AR015P	<u>AR015P/GL</u>		45
1.8 TS, 2.0 TS	(916C)	03.95 - 10.05			AR035A/GL			80		AR035P/GL			60
2.0 V6 Turbo, 3.0 V6	(916C)	03.95 - 10.05			AR036A/GL			80		AR036P/GL			60

MITO

excl. 1.4 Bifuel	(955)	09.08 -			AR051AS/GL					AR051P/GL		
					AR051AD/GL							

MONTREAL

2.6	(105)	12.72 - 03.79			AR003A			50		AR003P			50
-----	-------	---------------	--	--	--------	--	--	----	--	--------	--	--	----

SPIDER

1.3, 1.6, 1.7, 2.0	(115)	03.66 - 12.93			AR003A			55		AR003P			70
1.8 TS, 2.0 TS	(916S)	09.94 - 04.05			AR035A/GL			80		AR035P/GL			60
2.0 Turbo V6, 3.0 V6	(916S)	09.94 - 04.05			AR036A/GL			80		AR036P/GL			60
	(939)	06.06 -			AR050A/GL					AR050P/GL			

OIL
GAS

OIL
GAS

ARO (R)

240

240, 243, 244	1976 -					$\frac{1}{6}$				LR001P/GL	$\frac{6}{6}$	
---------------	--------	--	--	--	--	---------------	--	--	--	-----------	---------------	--

AUDI (D)

50

	(86)	08.74 - 07.78		ACC18	AU005A	AU005A/GL		155		ACC82	AU005P	AU005P/GL		55
--	------	---------------	--	-------	--------	-----------	--	-----	--	-------	--------	-----------	--	----

80

L, S, LS, GLS, GT	(80, 82, B1)	05.72 - 08.78		ACC18	AU003A	AU003A/GL				ACC84	AU003P			
GTE	(80, 82, B1)	01.76 - 08.78		ACC18	AU003A	AU003A/GL				ACC84	AU003P			
Avant	(80, 82, B1)	01.75 - 08.78		ACC18	AU003A	AU003A/GL				ACC84	VW006P		$\frac{6}{6}$	
, excl. Quattro	(81, 85, B2)	09.78 - 08.86		ACC19	AU012A	AU012A/GL		195		ACC84	AU012P	AU012P/GL		85
Quattro 4X4	(81, 85, B2)	08.84 - 08.86		ACC19		AU012A/GL		195						
excl. Quattro,	(89, 89Q, 8A, B3)	06.86 - 07.91		ACC19	AU012A	AU012A/GL		220		ACC84	AU012P	AU012P/GL		85
excl. Quattro	(89, 89Q, 8A, B3)	06.86 - 07.91		ACC19		AU012A/GL		220		ACC84				85
Quattro 4X4	(89, 89Q, 8A, B3)	09.86 - 07.91		ACC19		AU012A/GL		220						
excl. Quattro, 2.6 V6, 2.8 V6, S2,	(8C, B4)	08.91 - 09.94		ACC19	AU012A	AU012A/GL		220		ACC84	AU015P/GL			55
2.6 V6, 2.8 V6 excl.	(8C, B4)	08.91 - 09.94		ACC19		AU012A/GL		220		ACC84	AU015P/GL			55
	(8C, B4)	08.91 - 09.94		ACC19		AU012A/GL		220						
Quattro 4X4	(8C, B4)	08.91 - 09.94		ACC19		AU012A/GL		220					$\frac{6}{6}$	
Avant excl. 2.6 V6, 2.8 V6 excl. Quattro,	(8C, B4)	08.91 - 09.95		ACC19	AU012A	AU012A/GL		220		ACC84	AU015P/GL			55
Avant 2.6 V6, 2.8 V6 excl. RS2,	(8C, B4)	08.91 - 09.95		ACC19		AU012A/GL		220		ACC84	AU015P/GL			55
Avant Quattro 4X4	(8C, B4)	08.91 - 09.95		ACC19		AU012A/GL		220					$\frac{6}{6}$	
Avant	(8C, B4)	08.91 - 09.95		ACC19		AU012A/GL		220						

90

excl. Quattro	(81, 85, B2)	10.84 - 03.87		ACC19	AU012A	AU012A/GL		220		ACC84	AU012P	AU012P/GL		85
Quattro 4X4	(81, 85, B2)	08.85 - 03.87		ACC19		AU012A/GL		220						
excl. 2.3, Quattro,	(89, 89Q, 8A, B3)	04.87 - 07.91		ACC19	AU012A	AU012A/GL		220		ACC84	AU012P	AU012P/GL		85
excl. 2.3, Quattro	(89, 89Q, 8A, B3)	04.87 - 07.91		ACC19		AU012A/GL		220		ACC84				85
Quattro 4X4	(89, 89Q, 8A, B3)	04.87 - 07.91		ACC19		AU012A/GL		220						

100

1.6, 1.8, 2.2	(43, C2)	06.76 - 08.82		ACC62	AU006A	AU006A/GL		110			AU006P/GL	$\frac{1}{6}$	50
Avant 1.6, 1.8, 2.2		07.77 - 08.83		ACC62									
excl. Quattro	(44, 44Q, C3)	09.82 - 10.90		ACC62	AU006A	AU006A/GL		110	excl.	AU014P	AU014P/GL		135
Avant excl. Quattro		09.82 - 10.90											
Quattro 4X4	(44, 44Q, C3)	10.84 - 10.90		ACC62		AU006A/GL		110	excl.				
excl. Quattro, S4 V8	(4A, C4)	11.90 - 10.94		ACC62	AU006A	AU006A/GL		110	excl.	AU014P	AU014P/GL		135
Avant excl. Quattro, S4 V8		09.91 - 10.94											
Quattro 4X4 excl. S4 V8	(4A, C4)	11.90 - 10.94		ACC62		AU006A/GL		110	excl.				
Avant Quattro 4X4 excl. S4 V8		09.91 - 10.94											



OIL

GAS



OIL

GAS



AUDI (D)

- 1**
- Ⓛ Per le versioni GTE utilizzare la sede molla Audi art. 823-512-113.
 - Ⓞ Use Audi spring seat Nr. 823-512-113 for GTE models.
 - ⓕ Utiliser la coupelle Audi réf. 823-512-113 pour le modèle GTE.
 - ⓓ Für GTE ausführungen der Audi federsitzsteller Nr. 823-512-113 zu verwenden.
 - ⓔ En los modelos GTE utilice el asiento de muelle Audi n° 823-512-113.
 - Ⓟ Para o modelos GTE usar o assento de mola Audi n° 823-512-113.

- 2**
- Ⓛ Per i modelli dal 1976 al 1978 sostituire il tampone ed il parapolvere con l'art. Audi 431-412-131F e art. 431-412-135.
 - Ⓞ For 1976-78 models replace bumper and dust shield with Audi Nr. 431-412-131F and 431-412-135.
 - ⓕ Pour les modèles de 1976 a 78, remplacez la butée et le cahse-poussière par Audi N° 431-412-131F et 431-412-135.
 - ⓓ Für Modelle 1976-78, Puffer und Staubkappe durch Audi nr. 431-412-131F und 431-412-135 ersetzen.
 - ⓔ En los modelos 1976-78, sustituya el parachoques y el obturador antipolvo por la pieza Audi N° 431-412-131F y 431-412-135.
 - Ⓟ Para os modelos de 1976 a 78, substitua o párachoques e os resguardos contra o pópelos Audi n° 431-412-131F e 431-412-135.

200

	(43, C2)	10.79 - 08.82	ACC62	AU006A	AU006A/GL		110			AU006P/GL		50	
	excl. Quattro	(44, 44Q, C3)	06.83 - 10.90	ACC62	AU006A	AU006A/GL		110	excl.	AU014P	AU014P/GL		135
	Quattro 4X4	(44, 44Q, C3)	10.84 - 10.90	ACC62		AU006A/GL		110					

A1

	excl. S line	(8X1)	05.10 -			SE016A/GL					SD016P/GL		
	Sportback	(8XA)	09.11 -			SE016A/GL					SD016P/GL		

A2

	1.4 16V, 1.6 16V, 1.4 Tdi	(8Z)	02.00 - 08.05	3	SD003A	SD003A/GL		150			AU031P/GL		60
	excl. , 1.2 Tdi												
	1.4 16V, 1.6 16V, 1.2 Tdi, 1.4 Tdi	(8Z)	02.00 - 08.05	3	AU031A	AU031A/GL		150			AU031P/GL		60

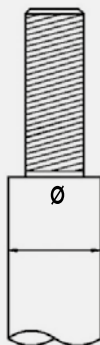

3

Ø 20 mm

Ø 22 mm

SD003A
SD003A/GL
VW035A
VW035A/GL

AU031A
AU031A/GL



OIL

GAS



OIL

GAS



AUDI (D)

A3

(8L1) excl. Quattro,	09.96 - 05.03		AU018A	AU018A/GL		120		<i>AU018P</i>	AU018P/GL	$\frac{1}{0}$	65
(8L1) excl. Quattro	09.96 - 05.03			AU018A/GL		120			AU028P/GL	$\frac{1}{0}$	65
Quattro 4X4 excl. , S3	(8L1) 12.96 - 06.99		AU018A	AU018A/GL		140			AU036P/GL	$\frac{0}{0}$	
Quattro 4X4, excl. S3	(8L1) 07.99 - 05.03			AU026A/GL		140			AU036P/GL	$\frac{0}{0}$	

A3 II

, incl. Sportback 4X2, Quattro 4X4 (8P1, 8PA) excl. ,	05.03 - 08.12	6		VW036A/GL		140			VW036P/GL	$\frac{1}{0}$	70
		7		AU038A/GL		140					
excl.	(8P1, 8PA) 05.03 - 08.12	6		VW037A/GL		140			VW037P/GL	$\frac{1}{0}$	70
		7		AU039A/GL		140					

A3 III

(8V1) excl. 4X4, S3,	04.12 -	6		VW046A/GL		140			VW045P/GL	$\frac{1}{0}$	70
		7		VW045A/GL		140					
4X4 excl. S3,	(8V1) 04.12 -	6		VW046A/GL		140			VW046P/GL	$\frac{1}{0}$	70
		7		VW045A/GL		140					
Sportback excl. 4X4, S3,	(8VA) 09.12 -	6		VW046A/GL		140			VW045P/GL	$\frac{1}{0}$	70
		7		VW045A/GL		140					
Sportback 4X4 excl. S3,	(8VA) 09.12 -	6		VW046A/GL		140			VW046P/GL	$\frac{1}{0}$	70
		7		VW045A/GL		140					
Limousine excl. 4X4, S3,	(8VS) 05.13 -	6		VW046A/GL		140			VW045P/GL	$\frac{1}{0}$	70
		7		VW045A/GL		140					
Limousine 4X4 excl. S3,	(8VS) 05.13 -	6		VW046A/GL		140			VW046P/GL	$\frac{1}{0}$	70
		7		VW045A/GL		140					

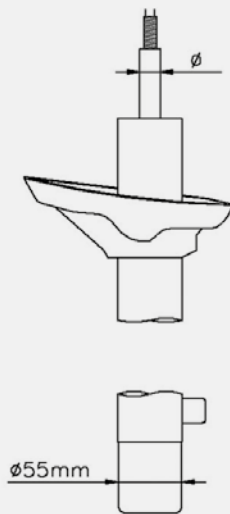

6

VW036A/GL
VW037A/GL
VW046A/GL

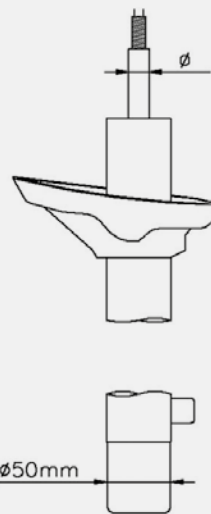

7

AU038A/GL
AU039A/GL
VW045A/GL

OIL
GAS

OIL
GAS

AUDI (D)

A4 (8D)

, excl. Quattro,	(8D, B5)	10.94 - 01.99			AU016A/GL		80			AU016P/GL		135
, excl. Quattro,	(8D, B5)	02.99 - 10.00			AU016A/GL		80			AU032P/GL		135
, excl. Quattro	(8D, B5)	10.94 - 01.99			AU021A/GL		80			AU016P/GL		135
, excl. Quattro	(8D, B5)	02.99 - 10.00			AU021A/GL		80			AU032P/GL		135
, Quattro 4X4 excl.	(8D, B5)	10.94 - 10.00			AU016A/GL		80			AU019P/GL		110
, Quattro 4X4,	(8D, B5)	10.94 - 10.00			AU021A/GL		80			AU019P/GL		110

A4 II (8E)

 excl. ,	(8E, B6)	11.00 - 12.04			AU033A/GL		80			AU033P/GL		80
 excl.	(8E, B6)	11.00 - 12.04			AU034A/GL		80			AU034P/GL		80
 excl. , Quattro	(8E, B7)	11.04 - 06.08			AU041A/GL		100			AU041P/GL		80
 excl. Quattro	(8E, B7)	11.04 - 06.08			AU042A/GL		100			AU042P/GL		80
Quattro excl.	(8E, B7)	11.04 - 06.08			AU043A/GL		100			AU042P/GL		80
Quattro	(8E, B7)	11.04 - 06.08			AU043A/GL		100			AU043P/GL		80

A4 III (8K) EXCL. ALLROAD

excl.	(8K2, 8K5)	11.07 -			AU050A/GL					AU050P/GL		
	(8K2, 8K5)	11.07 -			AU052A/GL					AU052P/GL		

A5

excl.	(8T, 8F)	06.07 -			AU050A/GL					AU050P/GL		
	(8T, 8F)	06.07 -			AU052A/GL					AU052P/GL		

A6 (4A)

excl. Quattro, , S6 Avant excl. Quattro, , S6	(4A, C4)	06.94 - 02.97 06.94 - 12.97		AU006A	AU006A/GL		110	excl.	AU014P	AU014P/GL		135
Quattro excl. S6, Avant Quattro excl. S6,	(A4, C4)	06.94 - 02.97 06.94 - 12.97			AU006A/GL		110	excl.		AU022P/GL		
Quattro excl. S6, Avant Quattro excl. S6,	(A4, C4)	06.94 - 02.97 06.94 - 12.97			AU006A/GL		110	excl.		AU051P/GL		

OIL
GAS

OIL
GAS

AUDI (D)

A6 II (4B)

excl. Quattro,	(4B, C5)	01.97 - 01.99			AU023A/GL		70	excl.		AU023P/GL		55
excl. Quattro,		12.97 - 01.99										
→ Ch. 4B-X-070000												
excl. Quattro	(4B, C5)	05.97 - 01.99			AU021A/GL		70	excl.		AU023P/GL		55
→ Ch. 4B-X-070000												
Quattro 4X4	(4B, C5)	05.97 - 01.99			AU023A/GL		70	excl.		AU024P/GL		55
→ Ch. 4B-X-070000												
excl. Quattro,	(4B, C5)	01.99 - 04.00			AU023A/GL		70	excl.		AU023P/GL		55
excl. Quattro,		01.99 - 04.00										
Ch. 4B-X-070001 → Ch. 4B-Y-200000												
excl. Quattro	(4B, C5)	01.99 - 04.00			AU021A/GL		70	excl.		AU023P/GL		55
Ch. 4B-X-070001 → Ch. 4B-Y-200000												
Quattro 4X4	(4B, C5)	01.99 - 04.00			AU023A/GL		70	excl.		AU024P/GL		55
Ch. 4B-X-070001 → Ch. 4B-Y-200000												
excl. Quattro,	(4B, C5)	05.00 - 04.04			AU044A/GL		70	excl.		AU023P/GL		55
excl. Quattro,		05.00 - 04.04										
Ch. 4B-1-000001 →												
excl. Quattro	(4B, C5)	05.00 - 04.04			AU045A/GL		70	excl.		AU023P/GL		55
Ch. 4B-1-000001 →												
Quattro 4X4 excl.	(4B, C5)	05.00 - 04.04			AU044A/GL		70	excl.		AU046P/GL		55
Ch. 4B-1-000001 →												

A6 III (4F) EXCL. ALLROAD

excl. Quattro,	(4F2, C6)	05.04 - 03.11			AU047A/GL					AU047P/GL		
excl. Quattro,	(4F5, C6)	03.05 - 08.11										
excl. Quattro	(4F2, C6)	05.04 - 03.11			AU048A/GL					AU047P/GL		
excl. Quattro	(4F5, C6)	03.05 - 08.11										
Quattro excl.	(4F2, C6)	05.04 - 03.11			AU049A/GL					AU047P/GL		
Quattro excl.	(4F5, C6)	03.05 - 08.11										

A6 IV (4G) EXCL. ALLROAD

excl.	(4G2, C7)	03.11 -										
excl.	(4G5, C7)	05.11 -										
	(4G2, C7)	03.11 -										
	(4G5, C7)	05.11 -										

A8

excl.	(4D2, 4D8)	06.94 - 12.98			AU020A/GL		80			AU020P/GL		120
-------	------------	---------------	--	--	-----------	--	----	--	--	-----------	--	-----

CABRIOLET

	(8G7, B4)	08.91 - 08.00		ACC19	AU012A/GL		220					
--	-----------	---------------	--	-------	-----------	--	-----	--	--	--	--	--

COUPÈ



excl. Quattro	(81, 85)	08.80 - 09.88		ACC19	AU012A	AU012A/GL		220		ACC84	AU012P	AU012P/GL		85
excl. Quattro, S2	(89, 8B)	10.88 - 07.91		ACC19		AU012A/GL		220						85
Quattro 4X4	(81, 85, 89, 8B)	01.84 - 07.91		ACC19		AU012A/GL		220						220
excl. Quattro, S2,	(89, 8B)	08.91 - 12.96		ACC19		AU012A/GL		220						85
Quattro 4X4	(89, 8B)	08.91 - 12.96		ACC19		AU012A/GL		220						

OIL
GAS

OIL
GAS

AUDI (D)













Q3

 excl. RS, 	(8U)	06.11 -			VW043A/GL					VW043P/GL	$\frac{1}{0}$	
---	------	---------	--	--	-----------	---	--	--	--	-----------	---------------	--



Q5

 excl. S line	(8R)	11.08 -			AU050A/GL					AU050P/GL	$\frac{1}{0}$	
--	------	---------	--	--	-----------	---	--	--	--	-----------	---------------	--

TT

 ,  4X2 excl.  , 3.2 V6	(8N3, 8N9)	10.98 - 10.06			AU026A/GL		120			AU026P/GL	$\frac{1}{0}$	80
 ,  Quattro 4X4 excl.  , 3.2 V6	(8N3, 8N9)	10.98 - 10.06			AU026A/GL		120			AU036P/GL	$\frac{0}{0}$	80
 excl. S line	(8J3)	10.06 -			AU053A/GL		140			AU053P/GL	$\frac{1}{0}$	70
 excl. S line	(8J9)	02.07 -			AU053A/GL		140			AU053P/GL	$\frac{1}{0}$	70

V8

 3.6, 4.2	(D1)	10.88 - 02.94		ACC62	AU006A/GL		110				$\frac{1}{0}$	55
--	------	---------------	---	-------	-----------	---	-----	--	--	--	---------------	----



OIL

GAS



OIL

GAS



AUSTIN (GB)

MAESTRO

excl. 2.0 MG EFI, Turbo,	(XC)	1983 - 1994	1 ACC18	AS002A AS003A	AS002A/GL AS003A/GL		90	2 ACC68	AS002P AS003P	AS002P/GL AS003P/GL		100
2.0 MG EFI, Turbo	(XC)	1984 - 1994	1 ACC18		AS002A/GL AS003A/GL		90	2 ACC68	AS002P AS003P	AS002P/GL AS003P/GL		100
	(XC)	1985 - 1990	1	AS004A			90		AS004P			50
	(XC)	1990 - 1994	1	AS004A			90		AS005P			50

METRO

		1980 - 1990		AS001A			75					
--	--	-------------	--	--------	--	--	----	--	--	--	--	--

MINI

0.85, Cooper, Cooper S		1965 - 1969		IN003A			40		IN003P			90
0.85, 1.0, 1.1, 1.3, GT, Cooper		1970 -										
Innocenti		1974 - 1981										
, ,		1961 - 1981		IN003A			40		IN012P			90
		1961 - 1981		IN003A			40					

MONTEGO

excl. 2.0 MG Turbo,	(XE)	04.84 - 12.94	1 ACC18	AS002A AS003A	AS002A/GL AS003A/GL		90	2 ACC68	AS002P AS003P	AS002P/GL AS003P/GL		100
2.0 MG Turbo excl.	(XE)	1985 - 02.87	1 ACC18		AS002A/GL		90		AS006P			100
2.0 MG Turbo		03.87 - 1994	1 ACC18		AS003A/GL		90					
excl.	(XE)	10.84 - 12.94	1 ACC18	AS002A AS003A	AS002A/GL AS003A/GL		90	2 ACC68	AS002P AS003P	AS002P/GL AS003P/GL		100

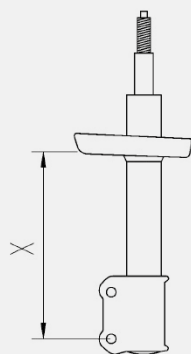

- 1** X = 264 mm
AS002A / AS002A/GL
- X = 250 mm
AS003A / AS003A/GL
- X = 271 mm
AS004A

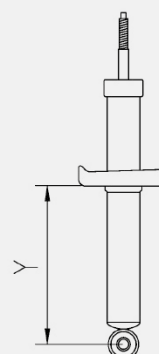

- 2** Y = 157 mm
AS002P / AS002P/GL
- Y = 181 mm
AS003P / AS003P/GL

- 3** **1** Se il veicolo è munito di correttore d'assetto, sostituire la molla con un Austin rif. NAM 6271 e anello NAM 3580.
- 2** If the vehicle is equipped with a self levelling suspension, replace the spring by a Austin one N° NAM 6271 and collar N° NAM 3580
- 3** Si le véhicule est équipé d'un correcteur d'assiette, remplacez le ressort par un Austin Réf. NAM 6271 et bague NAM 3580.
- 4** Wenn das Fahrzeug mit automatischem Niveau-Ausgleich-System versehen ist, Originalfeder durch Austin Feder Nr. NAM 6271 und Ringe NAM 3580 ersetzen.
- 5** Si el vehículo está equipado con suspensión autonivelada, sustituya el muelle por un muelle Austin N° NAM 6271 y arandela N° NAM 3580.
- 6** Se o veículo estiver equipado com uma suspensão autonivelável, substitua a mola por uma Austin, ref. NAM 6271 e por uma manga NAM 3580.



		OIL	GAS				OIL	GAS		
--	--	------------	------------	--	--	--	------------	------------	--	--

AUTOBIANCHI (I)

A 112

Ch. 47201→	1969 - 1987		AB005A			40		FI012P			75
------------	-------------	--	--------	--	--	----	--	--------	--	--	----

Y 10

4X2	(156)	03.85 - 1992	 → 	AB006AS AB006AD	AB006AS/GL AB006AD/GL	 	80		AB006P	AB006P/GL		40
4X2	(156)	1993 - 1996	 → 	AB006AS AB006AD	AB006AS/GL AB006AD/GL	 	80		AB007P	AB007P/GL		40
4X4	(156)	03.85 - 1992	 → 	AB006AS AB006AD	AB006AS/GL AB006AD/GL	 	80		FI037P	FI037P/GL		40
4X4	(156)	1993 - 1996	 → 	AB006AS AB006AD	AB006AS/GL AB006AD/GL	 	80			FI049P/GL		40

BARKAS (DDR)

B1000

	1962 - 1965			<i>OGMIPGL</i>					<i>OGMIPGL</i>		
	1965 -								<i>OGMIPGL</i>		

OIL
GAS

OIL
GAS

BEDFORD (GB)

ASTRA

Astra	1982 - 1984	ACC59	OG013A	OG013A/GL		145		OG014P			50
Astra	1984 - 07.91	ACC59	OG013A	OG013A/GL		145		OG034P	OG034P/GL		50
AstraMax	1985 - 07.91	ACC59	OG013A	OG013A/GL		145		OG026P			50

CF

14, 18, 22, 25, 35 CWT	1970 - 1975		<u>BEO01A</u>			45		<u>BEO01P</u>	<u>SB003A/GL</u>		25
220, 250, 280, 340	1976 - 1982		<u>BEO01A</u>			45		<u>BEO01P</u>			25
350	1976 -		<u>BEO01A</u>			45					
CF 18, 22, 25 CWT	1984 -		<u>BEO01A</u>			45		FI019P			25
			<u>BEO05A</u>			45					
35 CWT	1983 - 1984		<u>BEO01A</u>			45		<u>BEO01P</u>			25
35 CWT	1984 -		<u>BEO05A</u>			45		<u>BEO01P</u>			25
CF 97170/97370			<u>BEO01A</u>			45		FI019P			25
			<u>BEO05A</u>			45					
CF 97170/97370			<u>BEO01A</u>			45		<u>BEO01P</u>			25
			<u>BEO05A</u>			45					

CHEVANNE

9 CWT	1976 -		OG009A					OG001P/GL			
-------	--------	--	--------	--	--	--	--	-----------	--	--	--

KB

	1980 -			NI012A/GL		40			MT001P/GL		30
--	--------	--	--	-----------	--	----	--	--	-----------	--	----

MIDI

4X2	1985 -		<u>BEO02A</u>			30		L4002P	L4002P/GL		25
4X4	1985 -							L4002P	L4002P/GL		25

RASCAL

	1986 -	 	<u>BEO03AS</u> <u>BEO03AD</u>		 			<u>BEO03P</u>			25
	1986 -	 	<u>BEO03AS</u> <u>BEO03AD</u>		 			<u>BEO04P</u>			25

OIL
GAS

OIL
GAS

BMW (D)

1 SERIES (E81, E82, E87, E88)

116i, 118i, 120i, 130i excl.	(E81, E87)	09.04 - 09.12			BW056AS/GL		120			BW056P/GL	$\frac{1}{2}$	60
116d, 118d, 120d, 123d excl.					BW056AD/GL							
120i, 125i, 135i, 118d, 120d, 123d excl. 3.0 M,	(E82)	10.07 -			BW056AS/GL		120			BW056P/GL	$\frac{1}{2}$	60
118i, 120i, 125i, 135i, 118d, 120d, 123d excl.	(E88)	03.08 -			BW056AS/GL		120			BW056P/GL	$\frac{1}{2}$	60
					BW056AD/GL							

1 SERIES (F20, F21) EXCL. M-TECHNIK

excl. , xDrive	(F20)	12.10 -			BW075A/GL					BW075P/GL	$\frac{1}{2}$	
excl. , xDrive	(F21)	12.11 -			BW075A/GL					BW075P/GL	$\frac{1}{2}$	

3 SERIES (E21)

excl. 323i,		06.75 - 08.82		BW011A			165		BW011P	BW011P/GL		110
		06.75 - 08.82			<i>BW021AGL</i>		170			BW011P/GL		110
323i		09.77 - 08.82										

3 SERIES (E30) EXCL. M-TECHNIK

316, 318, 320, 324 D excl.		09.82 - 09.87	1 	<i>BW016A</i>	BW016A/GL		140			BW016P/GL	$\frac{1}{2}$	50
316, 318, 320, 324 D		09.82 - 09.87	2 	BW025A	BW025A/GL		140			BW016P/GL	$\frac{1}{2}$	50
323i		09.82 - 09.87	2		BW025A/GL		140			BW016P/GL	$\frac{1}{2}$	50
325e, 325i		02.85 - 09.87										
325iX 4X4 excl.		09.85 - 08.91								BW016P/GL	$\frac{1}{2}$	50
318i, 320i, 325i		12.85 - 10.93	2 		BW025A/GL		140			BW016P/GL	$\frac{1}{2}$	50
316i, 318i, 318is, 320i, 324 D excl.		10.87 - 08.90	1 	<i>BW016A</i>	BW016A/GL		140			BW016P/GL	$\frac{1}{2}$	50
316i, 318i, 318is, 320i, 324 D		10.87 - 08.90	2 		BW025A/GL		140			BW016P/GL	$\frac{1}{2}$	50
320is, 325i, 325e		10.87 - 08.90	2		BW025A/GL		140			BW016P/GL	$\frac{1}{2}$	50
324 TD		10.87 - 08.90										
Touring 316i excl.		10.87 - 06.94	1	<i>BW016A</i>	BW016A/GL		140			BW016P/GL	$\frac{1}{2}$	50
Touring 318i excl.		10.87 - 06.94										
Touring 318is, 320i, 320is, 325i, 325is		10.87 - 06.94	2		BW025A/GL		140			BW016P/GL	$\frac{1}{2}$	50
Touring 324 TD		10.87 - 06.94										

1	<ul style="list-style-type: none"> Installare su montante Mac-Pherson di diametro esterno 45 mm. Fits vehicles with outside strut diameter of 45 mm. Pour une jamb dont le diamètre extérieur est de 45 mm. Bei einem äusseren federbeindurchmesser von 45 mm. verwenden. Para vehículos con diámetro exterior de columna de 45 mm. Para uma escora cujo diâmetro exterior é de 45 mm. 	2	<ul style="list-style-type: none"> Installare su montante Mac-Pherson di diametro esterno 51 mm. Fits vehicles with outside strut diameter of 51 mm. Pour une jamb dont le diamètre extérieur est de 51 mm. Bei einem äusseren federbeindurchmesser von 51 mm. verwenden. Para vehículos con diámetro exterior de columna de 51 mm. Para uma escora cujo diâmetro exterior é de 51 mm.
----------	--	----------	--

OIL
GAS

OIL
GAS

BMW (D)

3 SERIES (E36) EXCL. M-TECHNIK

316i, 318i 318is	11.90 - 05.92 10.91 - 05.92	 3 ACC57	BW034AS/GL BW034AD/GL	160 160			BW034P/GL $\frac{1}{0}$ 60
320i, 325i, 325 TD 320i, 325i	11.90 - 05.92 10.91 - 05.92	 4 ACC57	BW041AS/GL BW041AD/GL	160 160			BW034P/GL $\frac{1}{0}$ 60
316i, 318i, 318is 318 TDS	06.92 - 02.98 06.92 - 02.98	 5 ACC57	BW036AS/GL BW036AD/GL	160 160			BW034P/GL $\frac{1}{0}$ 60
320i, 323i, 325i, 328i 325 TD, 325 TDS	06.92 - 02.98 06.92 - 02.98	 6 ACC57	BW046AS/GL BW046AD/GL	160 160			BW034P/GL $\frac{1}{0}$ 60
316i 318is	06.92 - 02.98 06.92 - 02.98	 5 ACC57	BW036AS/GL BW036AD/GL	160 160			BW034P/GL $\frac{1}{0}$ 60
320i, 323i 325i, 328i	06.92 - 02.98 06.92 - 02.98	 6 ACC57	BW046AS/GL BW046AD/GL	160 160			BW034P/GL $\frac{1}{0}$ 60
Compact 316i, 318Ti Compact 318 TDS	03.94 - 08.00 03.94 - 08.00	 5 ACC57	BW036AS/GL BW036AD/GL	160 160			BW036P/GL $\frac{1}{0}$ 60
318i, 320i, 323i 325i, 328i	03.93 - 04.99 03.93 - 04.99	 6 ACC57	BW046AS/GL BW046AD/GL	160 160			BW034P/GL $\frac{1}{0}$ 60
Touring 316i, 318i, 320i, 325i, 328i Touring 325 TD, 325 TDS	01.95 - 10.99 01.95 - 10.99	 5 ACC57	BW036AS/GL BW036AD/GL	160 160			BW043P/GL $\frac{1}{0}$ 60

3 4
5 6

- Vedi disegno/nota Bmw E36 a pagina 17
- See drawing/note Bmw E36 on page 17
- Voir plan/note Bmw E36 à la page 17
- Siehe Bmw E36 Zeichnung/Anmerkung auf Seite 17
- Ver dibujo/anotación Bmw E36 a la página 17
- Ver figura/nota Bmw E36 na página 17



ANTERIORE
FRONT

POSTERIORE
REAR



OIL

GAS



OIL

GAS



BMW (D)

3 SERIES (E36) EXCL. M-TECHNIK

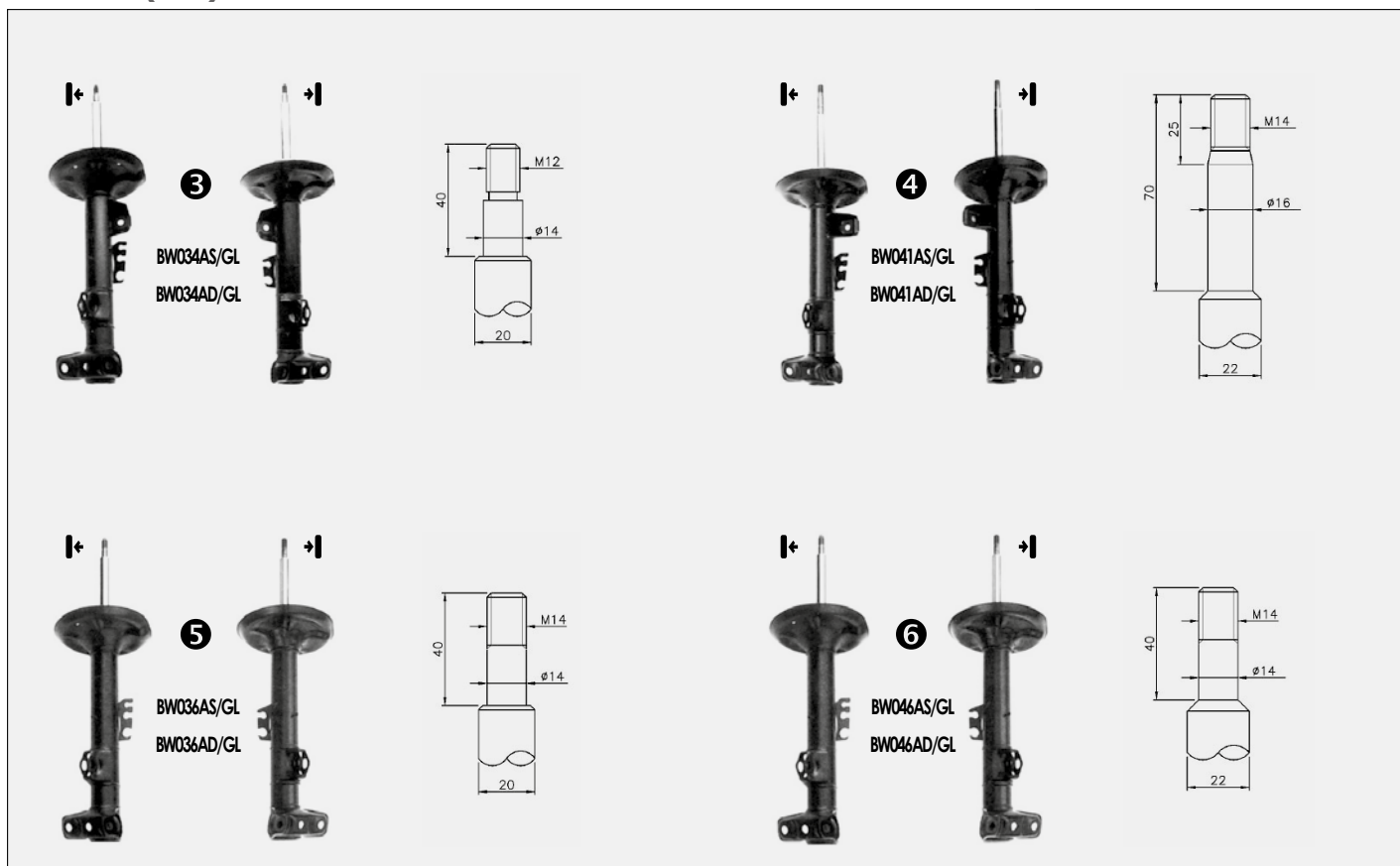

3 SERIES (E46) 4X2

316i, 318i, 320i excl. , M-Sport Pack II	02.98 - 09.01	 O.E. 31316759095 31316759096	BW051AS/GL BW051AD/GL	160	O.E. 33521095913	BW034P/GL	$\frac{1}{\sigma}$	60
316i, 318i, 318d excl. , M-Sport Pack II	09.01 - 04.05	 O.E. 31311096849 31311096850	BW061AS/GL BW061AD/GL	160	O.E. 33526759099	BW034P/GL	$\frac{1}{\sigma}$	60
320i, 320d, 325i excl. , M-Sport Pack II	09.01 - 04.05	 O.E. 31316759097 31316759098	BW062AS/GL BW062AD/GL	160	O.E. 33526759100	BW062P/GL	$\frac{1}{\sigma}$	60
330i, 330d incl.	06.00 - 04.05		BW060AS/GL BW060AD/GL	160		BW060P/GL	$\frac{1}{\sigma}$	60
316i, 318i, 320i, 325i , excl. M-Sport Pack II	02.98 - 09.01	 O.E. 31311096851 31311096852	BW063AS/GL BW063AD/GL	160	O.E. 33521095647	BW063P/GL	$\frac{1}{\sigma}$	60

OIL
GAS

OIL
GAS

BMW (D)

3 SERIES (E46) 4X2

320d , excl. M-Sport Pack II	02.98 - 09.01	 O.E. 31312282459 31312282460		BW060AS/GL BW060AD/GL	 	160	O.E. 33526757045		BW060P/GL		60
316i, 318i, 318d , excl. M-Sport Pack II	09.01 - 04.05	 O.E. 31311096851 31311096852		BW063AS/GL BW063AD/GL	 	160	O.E. 33521095647		BW063P/GL		60
320i, 325i, 320d , excl. M-Sport Pack II	09.01 - 04.05	 O.E. 31306757043 31306757044		BW064AS/GL BW064AD/GL	 	160	O.E. 33526757045		BW060P/GL		60
316Ci, 318Ci excl. , M-Sport Pack II	04.00 -	 		BW063AS/GL BW063AD/GL	 	160			BW063P/GL		60
320Ci excl. , M-Sport Pack II	04.99 - 04.01	 O.E. 31316759561 31316759562		BW062AS/GL BW062AD/GL	 	160	O.E. 33521095647		BW063P/GL		60
320 Ci excl. , M-Sport Pack II	04.01 - 09.01	 O.E. 31316759561 31316759562		BW062AS/GL BW062AD/GL	 	160	O.E. 33526757045		BW060P/GL		60
320 Ci excl. , M-Sport Pack II	10.01 -	 O.E. 31306757043 31306757044		BW064AS/GL BW064AD/GL	 	160	O.E. 33526757045		BW060P/GL		60
323Ci, 325Ci, 328Ci excl. , M-Sport Pack II	04.99 - 09.01	 		BW062AS/GL BW062AD/GL	 	160			BW052P/GL		60
330Ci excl. , M-Sport Pack II	06.00 - 04.01	 O.E. 31316759561 31316759562		BW062AS/GL BW062AD/GL	 	160	O.E. 33521096366		BW052P/GL		60
330Ci excl. , M-Sport Pack II	04.01 - 09.01	 O.E. 31316759561 31316759562		BW062AS/GL BW062AD/GL	 	160	O.E. 33526757045		BW060P/GL		60



		OIL	GAS				OIL	GAS		
--	--	------------	------------	--	--	--	------------	------------	--	--

BMW (D)

3 SERIES (E46) 4X2

330Ci 330Cd excl. , M-Sport Pack II	09.01 - 03.03 -	← → O.E. 31306757043 31306757044		BW064AS/GL BW064AD/GL	160	O.E. 33526757045	BW060P/GL	$\frac{1}{0}$	60
320Ci, 325Ci, 330Ci , excl. M-Sport Pack II	04.99 - 09.01					O.E. 33522282099	BW060P/GL	$\frac{1}{0}$	60
320Ci, 325Ci, 330Ci , excl. M-Sport Pack II	09.01 -	← → O.E. 31312282459 31312282460		BW060AS/GL BW060AD/GL	160	O.E. 33522282099	BW060P/GL	$\frac{1}{0}$	60
323Ci, 328Ci , excl. M-Sport Pack II	04.99 - 09.00	← → O.E. 31312282459 31312282460		BW060AS/GL BW060AD/GL	160	O.E. 33522282099	BW060P/GL	$\frac{1}{0}$	60
Touring 316i, 318i, 318d excl. , M-Sport Pack II	10.99 - 02.05	← →		BW061AS/GL BW061AD/GL	160		BW052P/GL	$\frac{1}{0}$	60
Touring 320i, 323i, 325i, 328i, 330i Touring 320d, 330d excl. , M-Sport Pack II	10.99 - 02.05 03.00 - 02.05	← →		BW062AS/GL BW062AD/GL	160		BW052P/GL	$\frac{1}{0}$	60
Touring 316i, 318i, 320i, 323i, 325i, 328i, 330i Touring 318d, 320d, 330d , excl. M-Sport Pack II	10.99 - 02.05 10.99 - 02.05	← → O.E. 31316750787 31316750788		BW063AS/GL BW063AD/GL	160	O.E. 33526750782 33526750784	BW052P/GL	$\frac{1}{0}$	60
318Ci, 320Ci, 323Ci, 325Ci, 330Ci, 320Cd excl. , M-Sport Pack II	04.00 -	← →		BW062AS/GL BW062AD/GL	160		BW052P/GL	$\frac{1}{0}$	60
318Ci, 320Ci, 323Ci, 325Ci, 330Ci, 320Cd , excl. M-Sport Pack II	04.00 - 09.01	← → O.E. 31316750791 31316750791		BW063AS/GL BW063AD/GL	160	O.E. 33526750782 33526750784	BW052P/GL	$\frac{1}{0}$	60
318Ci, 320Ci, 323Ci, 325Ci, 330Ci, 320Cd , excl. M-Sport Pack II	09.01 -	← → O.E. 31312282101 31312282102		BW060AS/GL BW060AD/GL	160				

OIL
GAS

OIL
GAS

BMW (D)

3 SERIES COMPACT (E46)

316ti, 318ti excl.	06.01 - 02.05	 		BW051AS/GL BW051AD/GL	 	160			BW034P/GL	$\frac{1}{0}$	60
325ti, 320td excl.	06.01 - 02.05	 		BW062AS/GL BW062AD/GL	 	160			BW062P/GL	$\frac{1}{0}$	60
316ti, 318ti 	06.01 - 03.02	 O.E. 31316759095 31316759096		BW051AS/GL BW051AD/GL	 	160	O.E. 33521095647		BW063P/GL	$\frac{1}{0}$	60
316ti, 318ti 	03.02 - 03.03	 O.E. 31312282097 31312282098		BW062AS/GL BW062AD/GL	 	160	O.E. 33526759099		BW034P/GL	$\frac{1}{0}$	60
316ti, 318ti 	03.03 - 02.05	 O.E. 31311096851 31311096852		BW063AS/GL BW063AD/GL	 	160	O.E. 33526759099		BW034P/GL	$\frac{1}{0}$	60
325ti, 320td 	06.01 - 09.01	 O.E. 31312282459 31312282460		BW060AS/GL BW060AD/GL	 	160	O.E. 33526757045		BW060P/GL	$\frac{1}{0}$	60
325ti, 320td 	09.01 - 02.05	 O.E. 31306757043 31306757044		BW064AS/GL BW064AD/GL	 	160	O.E. 33522282461		BW060P/GL	$\frac{1}{0}$	60

3 SERIES (E90) EXCL. M-TECHNIK

316i, 320i, 320d, 323i, 325i, 330i (E90) 318i, 318d, 330d excl. xi, xd, xDrive,	01.05 - 12.11	 		BW059AS/GL BW059AD/GL	 	120			BW059P/GL	$\frac{1}{1}$	60
---	---------------	------	--	--------------------------	------	-----	--	--	-----------	---------------	----

3 SERIES TOURING (E91) EXCL. M-TECHNIK

320i, 325i, 330i, 320d (E91) 330d excl. xi, xd, xDrive,	01.05 - 09.05 -	 		BW059AS/GL BW059AD/GL	 	120			BW059P/GL	$\frac{1}{1}$	60
---	--------------------	------	--	--------------------------	------	-----	--	--	-----------	---------------	----

3 SERIES (E92) EXCL. M-TECHNIK

320i, 325i, 330i, 335i (E92) 320d, 325d, 330d, 335d excl. xi, xd, xDrive,	06.06 -	 		BW059AS/GL BW059AD/GL	 	120			BW059P/GL	$\frac{1}{1}$	60
---	---------	------	--	--------------------------	------	-----	--	--	-----------	---------------	----

3 SERIES (E93) EXCL. M-TECHNIK

320i, 325i, 330i, 335i (E93) 320d, 325d, 330d, excl. xi, xd, xDrive,	08.06 -	 		BW059AS/GL BW059AD/GL	 	120			BW059P/GL	$\frac{1}{1}$	60
---	---------	------	--	--------------------------	------	-----	--	--	-----------	---------------	----



		OIL	GAS				OIL	GAS		
--	--	------------	------------	--	--	--	------------	------------	--	--

BMW (D)

3 SERIES (F30)

excl. xDrive, Active Hybrid	(F30)	10.11 -			BW076A/GL				BW076P/GL	$\frac{1}{0}$	
-----------------------------	-------	---------	--	--	------------------	--	--	--	------------------	---------------	--

3 SERIES (F31)

excl. xDrive, Active Hybrid	(F31)	06.12 -			BW076A/GL				BW076P/GL	$\frac{1}{0}$	
-----------------------------	-------	---------	--	--	------------------	--	--	--	------------------	---------------	--

3 SERIES GRAN TURISMO (F34)

excl. xDrive, Active Hybrid	(F34)	03.13 -			BW076A/GL				BW076P/GL	$\frac{1}{0}$	
-----------------------------	-------	---------	--	--	------------------	--	--	--	------------------	---------------	--

4 SERIES COUPÈ (F32)

excl. xDrive	(F34)	07.13 -			BW076A/GL				BW076P/GL	$\frac{1}{0}$	
--------------	-------	---------	--	--	------------------	--	--	--	------------------	---------------	--

5 SERIES (E12)

518 → Ch. 4632973	07.74 - 07.76		<u>BW022A</u>	<u>BW007A/GL</u>		150				$\frac{1}{0}$	
520 → Ch. 4717725	08.72 - 07.76										
520A → Ch. 4413736	08.72 - 07.76										
520i → Ch. 4454062	08.72 - 07.76										
525 → Ch. 4829406	08.73 - 07.76										
525A → Ch. 4516704	08.73 - 07.76										
528 → Ch. 4757067	01.75 - 07.76										
528A → Ch. 4551948	01.75 - 07.76										
530i → Ch. 5012010	01.73 - 07.76										
530iA → Ch. 5031674	01.73 - 07.76										
518, 520, 520A, 520i	07.76 - 06.81		<u>BW022A</u>	<u>BW007A/GL</u>		150			<u>BW022P/GL</u>		
518i, 520/6	09.77 - 06.81										
525, 525i	08.76 - 06.81										
528, 528A, 528i, 528iA	08.76 - 06.81										
530i, 530iA	08.76 - 12.80										

5 SERIES (E28) EXCL. M-TECHNIK

518, 518i, 520i, 525i, 528i	07.81 - 12.87		<u>BW017A</u>	<u>BW017A/GL</u>		150			<u>BW017P/GL</u>		60
524 D, 524 TD, 525e	05.83 - 12.87										

OIL
GAS

OIL
GAS

BMW (D)

5 SERIES (E34) EXCL. M-TECHNIK

518i excl. , ,	01.88 - 07.90	1 		BW030A/GL		165			BW023P/GL		90
518i	01.88 - 07.90	3 		BW032A/GL		165			BW023P/GL		90
518i excl. , ,	08.90 - 09.95	2 		BW031A/GL		165			BW023P/GL		90
518i	08.90 - 08.92	4 		BW033A/GL		165			BW023P/GL		90
518i	09.92 - 09.95	2 		BW031A/GL		165			BW023P/GL		90
520i excl. , ,	01.88 - 07.90	1 		BW030A/GL		165			BW023P/GL		90
520i	01.88 - 07.90	3 		BW032A/GL		165			BW023P/GL		90
520i excl. , ,	08.90 - 09.95	2 		BW031A/GL		165			BW023P/GL		90
520i	08.90 - 08.92	4 		BW033A/GL		165			BW023P/GL		90
520i	09.92 - 09.95	2 		BW031A/GL		165			BW023P/GL		90
525i excl. ,	01.88 - 07.90	3 		BW032A/GL		165			BW023P/GL		90
525i excl. ,	08.90 - 08.92	4 		BW033A/GL		165			BW023P/GL		90
525i excl. ,	09.92 - 09.95	2 		BW031A/GL		165			BW023P/GL		90
525iX excl. ,	05.91 - 09.95								BW023P/GL		90
530i excl. ,	01.88 - 07.90	3 		BW032A/GL		165			BW023P/GL		90
530i excl. ,	08.90 - 09.95	4 		BW033A/GL		165			BW023P/GL		90
535i excl. ,	01.88 - 07.90	3 		BW032A/GL		165			BW023P/GL		90
535i, 540i excl. ,	08.90 - 09.95	4 		BW033A/GL		165			BW023P/GL		90
524 TD excl. ,	01.88 - 07.90	3 		BW032A/GL		165			BW023P/GL		90
524 TD excl. ,	08.90 - 08.92	4 		BW033A/GL		165			BW023P/GL		90
525 TD, 525 TDS excl. ,	08.90 - 08.92	4 		BW033A/GL		165			BW023P/GL		90
525 TD, 525 TDS excl. ,	09.92 - 09.95	2 		BW031A/GL		165			BW023P/GL		90
Touring 518i, 520i excl. , ,	08.91 - 01.97	2 		BW031A/GL		165			BW023P/GL		90
Touring 518i, 520i	08.91 - 01.97	4 		BW033A/GL		165			BW023P/GL		90



		OIL	GAS				OIL	GAS		
--	--	------------	------------	--	--	--	------------	------------	--	--

BMW (D)

5 SERIES (E34) EXCL. M-TECHNIK

Touring 525i excl. ,	08.91 - 01.97	4		BW033A/GL		165				
Touring 530i, 535i, 540i excl. ,	08.91 - 01.97	4		BW033A/GL		165				
Touring 524 TD excl. ,	08.91 - 01.97	2		BW031A/GL		165		BW023P/GL		90
Touring 524 TD Touring 525 TDS excl. ,	08.91 - 01.97 08.91 - 01.97	4		BW033A/GL		165		BW023P/GL		90

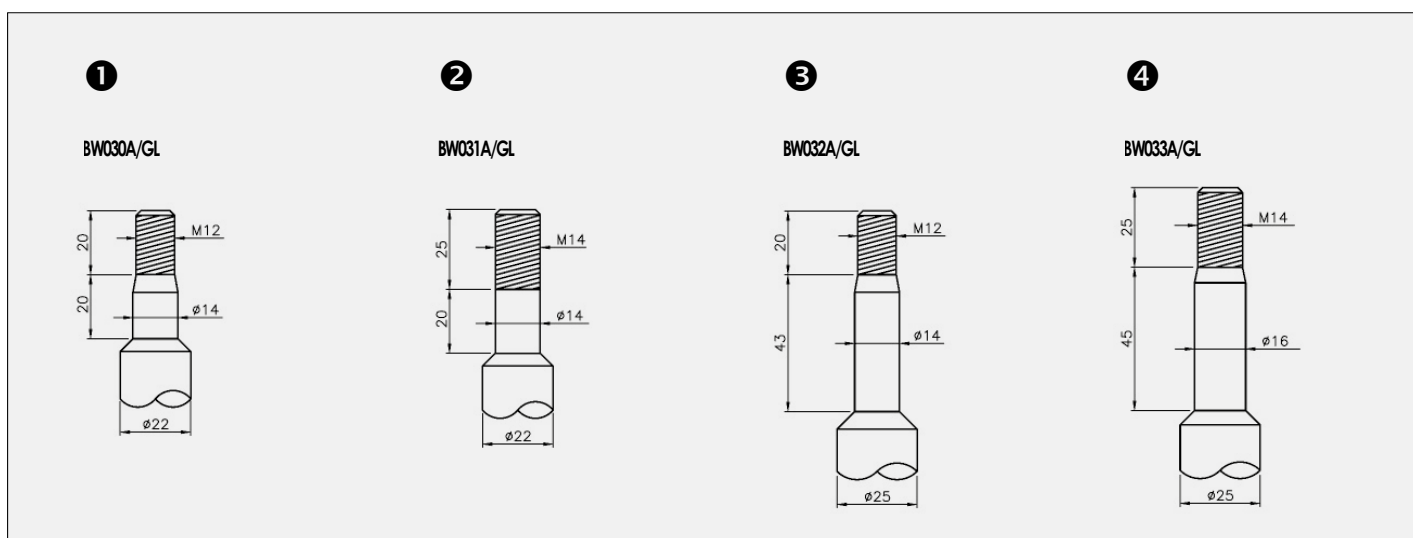

5 SERIES (E39) EXCL. M-TECHNIK

520i, 523i, 525i, 525 TDS, 528i, 530D excl.	11.95 - 06.03			BW040A/GL		140			BW040P/GL		120
535i, 540i excl.	11.95 - 06.03			BW053A/GL		140			BW040P/GL		120
Touring 520i, 523i, 525i, 525 TDS, 528i, 530D excl.	01.97 - 05.04			BW040A/GL		140			BW053P/GL		80
Touring 535i, 540i excl.	01.97 - 05.04			BW053A/GL		140			BW053P/GL		80

5 SERIES (E60) EXCL. M-TECHNIK

520i, 530i 530d	07.03 - 03.10			BW065AS/GL					BW065P/GL		
525i, 545i	09.03 - 03.10			BW065AD/GL							
525d	06.04 - 03.10										
535d	09.04 - 03.10			BW065AS/GL					BW065P/GL		
523i, 520d, 550i	07.05 - 03.10			BW065AD/GL							

5 SERIES TOURING (E61)

520i, 525i, 530i, 545i, 525d, 530d	06.04 -			BW066AS/GL					BW066P/GL		
535d	09.04 -			BW066AD/GL							
523i	07.05 -			BW066AS/GL					BW066P/GL		
				BW066AD/GL							

OIL
GAS

OIL
GAS

BMW (D)

5 SERIES (F10) EXCL. M-TECHNIK

523i, 528i, 535i, 550i excl. X-Drive (F10)	03.10 -			BW069AS/GL			excl.	BW069/GL		
520d, 525d, 530d, 535d excl. X-Drive				BW069AD/GL						

6 SERIES (E24) EXCL. M-TECHNIK

	04.76 - 06.78		<u>BW022A</u>	<u>BW007AGL</u>		150		<u>BW022PGL</u>		110
	06.78 - 05.82		<u>BW014A</u>	<u>BW014AGL</u>		150		<u>BW022PGL</u>		110
excl.	06.82 - 09.90		<u>BW017A</u>	<u>BW017AGL</u>		150	excl.	<u>BW017PGL</u>		110

6 SERIES (E63, E64) EXCL. M-TECHNIK

630i, 650i, 645Ci, 635d excl.	(E63) 01.04 -			BW065AS/GL			excl.	<u>BW070P/GL</u>		
630i, 650i, 645Ci, 635d excl.	(E64) 09.04 -			BW065AD/GL						

7 SERIES (E23)

728, 728i, 730, 733i	1977 - 09.79		<u>BW014A</u>	<u>BW014AGL</u>		180		<u>BW014PGL</u>		110
728i, 732i, 735i	09.79 - 09.81		<u>BW014A</u>	<u>BW014AGL</u>		180				
745i	07.79 - 08.86									
728i, 732i, 735i	10.81 - 08.86		<u>BW014A</u>	<u>BW014AGL</u>		180		<u>BW020PGL</u>		110

7 SERIES (E32) EXCL. M-TECHNIK

730i, 735i, 735iL excl. ,	09.86 - 02.88			<u>BW024AGL</u>		165	excl.	<u>BW024PGL</u>		90
730i, 735i, 735iL excl. ,	03.88 - 07.90			<u>BW029AGL</u>		165	excl.	<u>BW024PGL</u>		90
730i, 735i, 735iL excl.	08.90 - 07.94			<u>BW048AGL</u>		165	excl.	<u>BW024PGL</u>		90

7 SERIES (E38) EXCL. M-TECHNIK

725tds, 728i, 730i, 740i	05.94 - 11.01			BW049AS/GL		200	excl.	<u>BW049P/GL</u>		170
728iL, 730iL, 740iL, 750iL	05.94 - 11.01			BW049AD/GL						

7 SERIES (E65, E66) EXCL. M-TECHNIK

730i, 735i, 740i, 745i, 750i incl. Li excl.	11.01 -			BW071AS/GL			excl.	<u>BW071P/GL</u>		
730d, 730Ld excl.				BW071AD/GL						

7 SERIES (F01, F02, F03, F04) EXCL. M-TECHNIK

730i, 740i, 750i, 760i, excl.	06.08 -						excl.			
730d, 740d excl.										
excl. xDrive, Active Hybrid										

8 SERIES (E31) EXCL. M-TECHNIK

excl. ,	04.90 - 12.99									
---------	---------------	--	--	--	--	--	--	--	--	--

(E3)

2.5, 2.5 A, 2.8i, 2.8 LA, 3.0 S, 3.0 SA, 3.0 Si, 3.0 SiA, 3.0 L, 3.0 LA, 3.3 Li, 3.3 LA	10.68 - 04.77 10.68 - 04.77 10.68 - 04.77		<u>BW022A</u>	<u>BW007AGL</u>						
---	---	--	---------------	-----------------	--	--	--	--	--	--



		OIL	GAS				OIL	GAS		
--	--	------------	------------	--	--	--	------------	------------	--	--

BMW (D)

(E6, E10)

1600/2, Ti	09.67 - 12.71				/		<i>BW003P</i>		$\frac{1}{0}$	
1602, 1802, 2002, Ti	02.68 - 07.77									
1502	01.75 - 07.77									
Touring 1600, 1800	01.71 - 07.75									

(E9)

2.5 CS, 3.0 CS	01.74 - 12.76		<i>BW0224</i>	<i>BW007AGL</i>	/				$\frac{1}{0}$	
3.0 CSi	04.71 - 12.75									

X1

xDrive	(E84)	10.09 -			<i>BW073AS/GL</i>		excl.	<i>BW072P/GL</i>	$\frac{1}{+}$	
					<i>BW073AD/GL</i>					
sDrive	(E84)	10.09 -			<i>BW072AS/GL</i>		excl.	<i>BW072P/GL</i>	$\frac{1}{+}$	
					<i>BW072AD/GL</i>					

X3

2.5i, 3.0i, 3.0d	(E83)	01.04 -			<i>BW058AS/GL</i>			<i>BW058P/GL</i>	$\frac{1}{0}$	
2.0d		10.04 -			<i>BW058AD/GL</i>					

X5

3.0i, 4.4i	(E53)	05.00 -			<i>BW057AS/GL</i>			<i>BW057P/GL</i>	$\frac{1}{0}$	
3.0d		05.01 -			<i>BW057AD/GL</i>					
4.6is		02.02 -								
excl.										

X5 II

3.0 si, 3.0 d, 3.0 sd incl. xDrive	(E70)	02.07 -			<i>BW074A/GL</i>			<i>BW074PS/GL</i>	$\frac{1}{0}$	
excl. M, ,								<i>BW074PD/GL</i>	$\frac{1}{0}$	

X6

35i, 50i, 30d, 35d incl. xDrive	(E71, E72)	05.08 -			<i>BW074A/GL</i>			<i>BW074PS/GL</i>	$\frac{1}{0}$	
excl. M, , , Active Hybrid								<i>BW074PD/GL</i>	$\frac{1}{0}$	

Z3

1.8	(E36)	10.95 - 10.98			<i>BW036AS/GL</i>		100	<i>BW050P/GL</i>	$\frac{1}{0}$	80
1.9		07.98 -			<i>BW036AD/GL</i>					
2.0		04.99 -								
excl.										
2.2	(E36)	08.00 -			<i>BW036AS/GL</i>		100	<i>BW050P/GL</i>	$\frac{1}{0}$	80
2.8		04.97 - 06.00			<i>BW036AD/GL</i>					
3.0		06.00 -								
excl.										

Z4

2.5i, 3.0i	(E85)	02.03 -			<i>BW067AS/GL</i>			<i>BW067P/GL</i>	$\frac{1}{0}$	
2.2i		10.03 -			<i>BW067AD/GL</i>					
2.0i		04.05 -								

OIL
GAS

OIL
GAS

CHEVROLET (EU)

AVEO

	(T250, T255)	05.05 -			DW007AS/GL					DW007P/GL		
					DW007AD/GL							

CAPTIVA

	(C100, C140)	06.06 -			OG059AS/GL					OG059P/GL		
					OG059AD/GL							

CRUZE

	(J300, J305, J308)	05.09 -			OG063AS/GL					OG063P/GL		
		06.11 -			OG063AD/GL							

KALOS

		03.05 -			DW007AS/GL					DW007P/GL		
					DW007AD/GL							

LACETTI

	(J200)	03.05 -			DW009AS/GL					DW009PS/GL		
					DW009AD/GL					DW009PD/GL		

MATIZ

	(M220, M250)	03.05 -			DW010AS/GL					DW010P/GL		
					DW010AD/GL							

NUBIRA

		03.05 - 12.09			DW009AS/GL					DW009PS/GL		
		03.05 - 12.09			DW009AD/GL					DW009PD/GL		

SPARK

		05.05 -			DW010AS/GL					DW010P/GL		
					DW010AD/GL							

TACUMA

		03.05 -			DW011AS/GL					DW011P/GL		
					DW011AD/GL							



CHRYSLER (USA)

300 C

	(LX)	09.04 - 11.12			CR010AS/GL					CR010P/GL		
		09.04 - 12.10			CR010AD/GL							

NEON

	(PL)	10.93 - 08.99			CR004A/GL		80			CR004P/GL		90
excl.												
		08.99 - 12.06			CR008A/GL					CR008PS/GL		
										CR008PD/GL		

PT CRUISER

excl.		06.00 - 12.10			CR003A/GL		100			CR003P/GL		30
-------	--	---------------	--	--	-----------	--	-----	--	--	-----------	--	----

STRATUS/CIRRUS

	(JA)	12.95 - 04.01			CR009A/GL		130			CR009P/GL		75
	(JX)	04.96 - 04.01			CR009A/GL		130			CR009P/GL		75

VOYAGER I / II

	(AS)	08.84 - 12.85								CR001P/GL		60
4X2, 4X4	(ES)	01.86 - 01.95			CR001A/GL		140			CR001P/GL		60
incl. Grand Voyager, Grand Caravan												

VOYAGER III

excl. 4X4,	(GS)	02.95 - 03.01	1		CR002A/GL		180			CR001P/GL		70
incl. Grand Voyager, Grand Caravan												

VOYAGER IV

excl. 4X4	(RG)	02.00 -	2		CR007A/GL		180			CR001P/GL		70
incl. Grand Voyager, Grand Caravan												

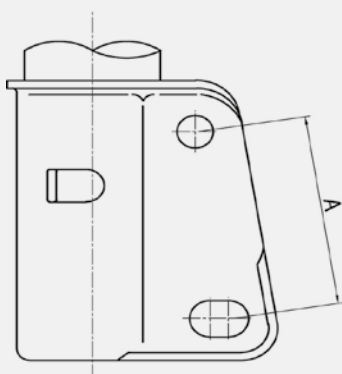

1

CR002A/GL
A = 65mm

2

CR007A/GL
A = 82mm

OIL
GAS

OIL
GAS

CITROËN (F)

2 CV

2 CV, 2 CV 4, 2 CV 6 AK 250	01.65 - 07.90		CI008A		⊖	85		CI008P		⊖	60
AK 400, AK 350	01.65 - 07.90										
AKS 400	01.63 - 06.76		CI008A		⊖	60				⊖	40
	07.76 -				⊖	75				⊖	45

ACADIANE

	08.78 - 10.83				⊖	75				⊖	45
--	---------------	--	--	--	---	----	--	--	--	---	----

AMI

Ami 6	01.61 - 05.63		CI008A		⊖	85		CI008P		⊖	60
Ami 6	06.63 - 07.69		CI008A		⊖	85				⊖	40
Ami 8 excl. Super	07.69 - 12.77										
Ami 8 Super	1973 -				⊖	75				⊖	45

AX

1.0, 1.1 (ZA)	07.86 - 12.98		CI014A	CI014A/GL	✍	160		CI014P	CI014P/GL	⊖	60
1.3 Sport (ZA)	04.87 - 12.88		CI014A	CI014A/GL	✍	160			CI014P/GL	⊖	
1.4 excl. GTi, 4X4 (ZA)	07.86 - 12.98		CI014A	CI014A/GL	✍	160		CI014P	CI014P/GL	⊖	60
1.4 D, 1.5 D excl. 4X4	09.88 - 12.98										
1.4 GTi (ZA)	05.91 - 12.96			CI014A/GL	✍	160			CI014P/GL	⊖	60
1.4 4X4	08.91 - 12.96										

AXEL/OLTCIT

	10.81 - 03.91		CI013A		⊖	80		CI013P		⊖	80
--	---------------	--	--------	--	---	----	--	--------	--	---	----

BERLINGO

excl. 4X4 (MF)	07.96 - 11.02	← →	CI019AS CI019AD	CI019AS/GL CI019AD/GL	✍ ✍	120		PG024P	PG024P/GL	⊖	60
excl. 4X4 (G)	12.02 -	← →		MG3077 MG3078	✍ ✍	120		PG024P	PG024P/GL	⊖	60
	04.08 -	← →		CI030AS/GL CI030AD/GL	✍ ✍				CI030P/GL	⊖	

C1

1.0i, 1.4d (PM, PN)	07.05 -	← →	CI027AS CI027AD	CI027AS/GL CI027AD/GL	✍ ✍				CI027P/GL	⊖	
---------------------	---------	--------	--------------------	--------------------------	--------	--	--	--	-----------	---	--

C2

1.1, 1.4 excl. (JM)	09.03 -	← →	CI024AS CI024AD	CI025AS/GL CI025AD/GL	✍ ✍	60			CI024P/GL	⊖	40
1.4 Hdi excl. (JM)	09.03 -	← →	CI024AS CI024AD	CI024AS/GL CI024AD/GL	✍ ✍	60			CI024P/GL	⊖	40
1.6 16V (JM)	09.03 -	← →		CI024AS/GL CI024AD/GL	✍ ✍	60			CI024P/GL	⊖	40



CITROËN (F)

C3

1.1, 1.4 excl.	(FC)	04.02 -	 	<i>CI024AS</i> <i>CI024AD</i>	CI024AS/GL CI024AD/GL	 	60			CI024P/GL		40
1.6, 1.4 Hdî excl.	(FC)	04.02 -	 	<i>CI024AS</i> <i>CI024AD</i>	CI024AS/GL CI024AD/GL	 	60			CI024P/GL		40
 	(FC)	04.02 -	 O.E. 5202.HE 5202.HF		CI024AS/GL CI024AD/GL	 	60			CI024P/GL		40
Pluriel	(HB)	05.03 -	 		CI025AS/GL CI025AD/GL	 	60			CI024P/GL		40

C3 II

		11.09 -	 ①		CI032AS/GL CI032AD/GL	 				CI032P/GL		
		11.09 -	 ②		CI033AS/GL CI033AD/GL	 				CI032P/GL		

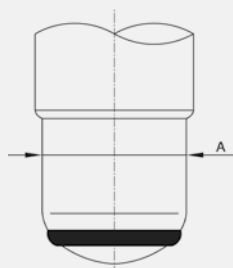
①

 CI032AD/GL
 CI032AS/GL
 A = 51 mm

②

 CI033AS/GL
 CI033AD/GL
 A = 47 mm

 VERIFICARE DIAMETRO MOZZO ORIGINALE
 CHECK THE ORIGINAL HUB DIAMETER

C3 PICASSO

		02.09 -	 		PG046AS/GL PG046AD/GL	 				PG046P/GL		
--	--	---------	------	--	--------------------------	------	--	--	--	-----------	--	--

C4

 excl. 2.0 Hdî (136 HP), 2.0 16V (177 HP)	(LC)	11.04 -	 		PG041AS/GL PG041AD/GL	 				PG041P/GL		
, 2.0 Hdî (136 HP), 2.0 16V (177 HP)	(LC)	11.04 -	 		PG041AS/GL PG041AD/GL	 				PG045P/GL		

C4 II

	(B7)	11.09 -	 		CI034AS/GL CI034AD/GL	 				CI034P/GL		
--	------	---------	------	--	--------------------------	------	--	--	--	-----------	--	--

C4 PICASSO/GRAND PICASSO

Picasso	(UD)	02.07 -	 		CI030AS/GL CI030AD/GL	 				CI030P/GL		
Gran Picasso	(UA)	10.06 -	 		CI030AS/GL CI030AD/GL	 				CI030P/GL		

OIL
GAS

OIL
GAS

CITROËN (F)

C5

, Excl.	(RD, TD)	02.08 -			PG047A/GL					PG047P/GL		
----------	----------	---------	--	--	-----------	--	--	--	--	-----------	--	--

C8

	(EA, EB)	06.02 -			LN049AS/GL					LN049P/GL		
					LN049AD/GL							

C15

1.0, 1.1, 1.4 (XW7, VDP A → Ch. 4195) excl. 4X4	(VD)	10.84 - 05.88		ACC56	C1006A	C1006A/GL		170		PG010P		160
1.0, 1.1, 1.4 (TU, VDP Y Ch. 4196 →) excl. 4X4	(VD)	05.88 -		ACC56	PG020A	PG016A/GL		170		PG010P		160
1.3 (G1A, VDP V, Ch. 3887 → 4237) excl. 4X4	(VD)	07.87 - 06.88		ACC56	PG020A	PG016A/GL		200		PG010P		160
1.8 D, 1.9 D 475 Kg , 600 Kg, excl. 4X4	(VD)	07.86 -										
1.8 D, 1.9 D 760 Kg excl. 4X4	(VD)	07.86 -		ACC56	PG016A			200		PG010P		160

C25

,	(280, 290)	07.81 - 12.85		ACC100	FI143A			150	1	FI143P			50
	(280, 290)	07.81 - 12.85		ACC100	FI143A			150	2	FI304P			50
, excl. 1800 Kg	(280, 290)	01.86 - 03.94		ACC100	FI304A			200	1	FI143P			50
1800 Kg	(280, 290)	01.86 - 03.94		ACC100	FI300A			200	3	FI300P			50
	(280, 290)	01.86 - 03.94		ACC100	FI304A			200	2	FI304P			50

1 2 3

1 Vedi disegno/nota Fiat Ducato a pagina 40

2 See drawing/note Fiat Ducato on page 40

3 Voir plan/note Fiat Ducato à la page 40

D Siehe Fiat Ducato Zeichnung/Anmerkung auf Seite 40

E Ver dibujo/ anotación Fiat Ducato a la página 40

P Ver figura/note Fiat Ducato na página 40

C32, C35

		11.73 - 01.94			FI108A				60		FI108P			60
--	--	---------------	--	--	--------	--	--	--	----	--	--------	--	--	----

C-CROSSER

2.4, 2.2 Hdi	(EP)	02.07 -			C1031AS/GL					C1031P/GL		
					C1031AD/GL							

DYANE

excl. Acadyane		08.67 - 10.84			C1008A				85		C1008P			60
----------------	--	---------------	--	--	--------	--	--	--	----	--	--------	--	--	----

OIL
GAS

OIL
GAS

CITROËN (F)

DS3

	04.10 -	 		CI032AS/GL CI032AD/GL	 			CI032P/GL 	
	04.10 -	 		CI033AS/GL CI033AD/GL	 			CI032P/GL 	

1 2	Vedi disegno/note Citroen C3 a pagina 29 See drawing/note Citroen C3 on page 29 Voir plan/note Citroen C3 à la page 29	Siehe Citroen C3 Zeichnung/Anmerkung auf Seite 29 Ver dibujo/anotación Citroen C3 a la página 29 Ver figura/note Citroen C3 na página 29
------------	--	--

DS4

	04.11 -	 		CI034AS/GL CI034AD/GL	 			CI034P/GL 	
--	---------	------	--	--------------------------	------	--	--	---------------	--

EVASION/SYNERGIE

(-> Ch. 7609)	(22, U6)	03.94 - 12.97		FI082A/GL	 	90	4	<i>FI082P</i>	FI082P/GL	 	45
(Ch. 7610 ->)	(22, U6)	01.98 - 07.02		FI082A/GL	 	90	5		LN042P/GL	 	45

JUMPER/RELAY

1000 Kg, 1400 Kg	(230L)	02.94 - 04.02	 3	FI320A	FI320A/GL	 	170	3	FI320P	FI320P/GL	 	45
1800 Kg	(230L)	02.94 - 04.02	 3	FI322A	FI322A/GL	 	170	3	FI322P	FI322P/GL	 	45
	(230P)	02.94 - 04.02	 3	FI320A	FI320A/GL	 	170				 	
1000 Kg, 1400 Kg	(244)	04.02 -	 3	FI320A	FI320A/GL	 	170	3	FI320P	FI320P/GL	 	45
1800 Kg	(244)	04.02 -	 3	FI322A	FI322A/GL	 	170	3	FI322P	FI322P/GL	 	
1000Kg 1400Kg	(250)	04.06 -	3		FI360A/GL	 		3		FI341P/GL	 	
1400Kg 2000Kg	(250)	04.06 -	3		FI361A/GL	 		3		FI343P/GL	 	
1000Kg 1400Kg	REINFORCED (250)	04.06 -	3		FI341A/GL	 		3		FI341P/GL	 	
1400Kg 2000Kg	REINFORCED (250)	04.06 -	3		FI342A/GL	 		3		FI343P/GL	 	

3	Vedi disegni/note Fiat Ducato a pagina 40/41 See drawing/note Fiat Ducato on page 40/41 Voir plan/note Fiat Ducato à la page 40/41 Siehe Fiat Ducato Zeichnung/Anmerkung auf Seite 40/41 Ver dibujo/anotación Fiat Ducato a la página 40/41 Ver figura/note Fiat Ducato na página 40/41	4 5 6	Vedi disegno/note Fiat Scudo a pagina 44 See drawing/note Fiat Scudo on page 44 Voir plan/note Fiat Scudo à la page 44 Siehe Fiat Scudo Zeichnung/Anmerkung auf Seite 44 Ver dibujo/anotación Fiat Scudo a la página 44 Ver figura/note Fiat Scudo na página 44
----------	--	--------------	--

OIL
GAS

OIL
GAS

CITROËN (F)

JUMPY/DISPATCH

(→ Ch. 7609)	(U6U)	06.94 - 09.97		FI082A			90	4	<i>FI082P</i>	FI082P/GL		45
(Ch. 7610 → 9793)	(U6U)	09.97 - 10.03		FI082A			90	5		LN042P/GL		45
(Ch. 9794 → 10408)		10.03 - 05.04	 		CI026AS/GL CI026AD/GL	 	120	5		LN042P/GL		45
(Ch. 10409 →)		05.04 -		FI082A				5		LN042P/GL		45
1.6D, 2.0 D	(272)	01.07 -	 		FI345AS/GL FI345AD/GL	 	150	6		FI345P/GL		
1.6D, 2.0 D H.D.	(272)	01.07 -	 		FI346AS/GL FI346AD/GL	 	150	6		FI346P/GL		

4 5 6 **I** Vedi disegno/nota Fiat Scudo a pagina 44 **D** Siehe Fiat Scudo Zeichnung/Anmerkung auf Seite 44
GB See drawing/note Fiat Scudo on page 44 **E** Ver dibujo/anotación Fiat Scudo a la página 44
F Voir plan/note Fiat Scudo à la page 44 **P** Ver figura/note Fiat Scudo na página 44

LN/LNA

LN 0.6		- 04.77		CI005A	CI005A/GL		200		CI005P			115
LN 0.6		05.77 - 12.80		CI005A	CI005A/GL		200	5	CI006P			115
LNA 0.6, 1.1		11.78 - 10.86		CI006A	CI006A/GL		170	5	CI006P			115

MEHARI

excl. 4X4, F.A.F.		05.68 - 10.87		CI008A			85		CI008P			60
4X4, F.A.F.		10.79 - 10.87					75					45

NEMO

1.2 HDi, 1.4, 1.4 HDi N.D. Finestrato	(AA)	02.08 -	 		FI350AS/GL FI350AD/GL	 				FI350P/GL		
1.2 HDi, 1.4, 1.4 HDi H.D. Cassonato	(AA)	02.08 -	 		FI350AS/GL FI350AD/GL	 				FI364P/GL		

SAXO

1.0, 1.1	(S0, S1)	05.96 -		CI014A	CI014A/GL		160		CI014P	CI014P/GL		60
1.4	(S0, S1)	05.96 -		CI014A	CI014A/GL		160		CI014P	CI014P/GL		60
1.5 D		05.96 -										
1.6, 1.6 16V	(S0, S1)	05.96 -		CI014A	CI014A/GL		160			CI014P/GL		60

VISA

excl. Chrono, GT, GTI, 1.7 D		09.78 - 03.91		CI006A	CI006A/GL		170		CI010P			135
Chrono, GT, GT Tonic		09.78 - 03.91		CI006A	CI006A/GL		170		CI015P			135
1.6 GTI		01.85 - 03.91	 	PG021AS PG021AD	PG021AS/GL PG021AD/GL	 			CI015P			135
1.7 D		06.84 - 03.91		PG020A	PG016A/GL		170		CI010P			135

OIL
GAS

OIL
GAS

CITROËN (F)

XSARA

1.1, 1.4, 1.6, 1.8 excl. VTS 1.9 D, 1.9 TD, 2.0 Hdi excl. VTS	(N1, N0)	04.97 - 09.00 04.97 - 09.00	← →	<i>CI019AS</i> <i>CI019AD</i>	CI019AS/GL CI019AD/GL		220	N.D. H.D.	PG016P PG025P/GL	PG016P/GL PG025P/GL		55
VTS	(N0)	02.98 - 09.00	← →		CI019AS/GL CI019AD/GL		220			PG025P/GL		55
1.4 excl.	(N1, N0)	09.00 - 04.05	← →	<i>CI028AS</i> <i>CI028AD</i>	CI028AS/GL CI028AD/GL		220	N.D. H.D.	PG016P PG025P/GL	PG016P/GL PG025P/GL		55
1.6, 2.0, 2.0 VTS, 1.9 D, 2.0 Hdi excl.	(N1, N0)	09.00 - 04.05 09.00 - 04.05	← →	<i>CI029AS</i> <i>CI029AD</i>	CI029AS/GL CI029AD/GL		220	N.D. H.D.	PG016P PG025P/GL	PG016P/GL PG025P/GL		55
	(N2)	10.97 - 09.00	← →	<i>CI019AS</i> <i>CI019AD</i>	CI019AS/GL CI019AD/GL		220			PG025P/GL		55
1.4 excl.	(N2)	09.00 - 08.05 09.00 - 08.05	← →	<i>CI028AS</i> <i>CI028AD</i>	CI028AS/GL CI028AD/GL		220	N.D. H.D.	PG016P PG025P/GL	PG016P/GL PG025P/GL		55
1.6, 2.0, 2.0 VTS, 1.9 D, 2.0 Hdi excl.	(N2)	09.00 - 08.05	← →	<i>CI029AS</i> <i>CI029AD</i>	CI029AS/GL CI029AD/GL		220	N.D. H.D.	PG016P PG025P/GL	PG016P/GL PG025P/GL		55
	(N1, N0, N2)	09.00 - 08.05 09.00 - 08.05	← →				220			PG025P/GL		

XSARA PICASSO

	(N68)	12.99 -	← →	<i>CI023AS</i> <i>CI023AD</i>	CI023AS/GL CI023AD/GL		220		<i>CI023P</i>	CI023P/GL		55
--	-------	---------	--------	----------------------------------	--------------------------	--	-----	--	---------------	-----------	--	----

ZX

1.1 1.4	(N2)	03.91 - 06.97 03.91 - 06.97	← →	<i>CI016AS</i> <i>CI016AD</i>	CI016AS/GL CI016AD/GL		220		PG016P	PG016P/GL		55
1.6, 1.8 1.8 D, 1.9 D, 1.9 TD excl. Volcane	(N2)	03.91 - 06.97 03.91 - 06.97	← →	<i>CI019AS</i> <i>CI019AD</i>	CI019AS/GL CI019AD/GL		220	N.D. H.D.	PG016P PG025P/GL	PG016P/GL PG025P/GL		55
1.9, 2.0 → Ch. 5683	(N2)	03.91 - 03.92 03.91 - 03.92	← →		<i>CI020ASGL</i> <i>CI020ADGL</i>		220			PG025P/GL		55
1.9, 2.0 Ch. 5684 → 2.0 16V 1.9 TD Volcane	(N2)	06.91 - 06.97 03.91 - 06.97 03.91 - 06.97	← →		CI019AS/GL CI019AD/GL		220			PG025P/GL		55
	(N2)	10.93 - 10.97	← →	<i>CI019AS</i> <i>CI019AD</i>	CI019AS/GL CI019AD/GL		220		<i>CI019P</i>	CI019P/GL		55

OIL
GAS

OIL
GAS

DACIA (R)

1000 SERIES

1210, 1300, 1310, 1410	12.72 - 05.83		<i>RNO&A</i>			125		<i>RNO&P</i>		$\frac{1}{1}$	85
------------------------	---------------	--	------------------	--	--	-----	--	------------------	--	---------------	----

DOKKER

	11.12 -									$\frac{0}{0}$	
--	---------	--	--	--	--	--	--	--	--	---------------	--

DUSTER

1.5 dCi, 1.6 16V excl 4x4	04.10 -			DC006A/GL					DC006P/GL	$\frac{1}{0}$	
1.5 dCi, 1.6 16V incl 4x4	06.10 -			DC006A/GL					DC007P/GL		

LODGY

	06.10 -									$\frac{0}{0}$	
--	---------	--	--	--	--	--	--	--	--	---------------	--

LOGAN

1.4, 1.5 dCi, 1.6 16V	(SD)	09.04 -			DC001A/GL					DC001P/GL	$\frac{1}{0}$
MCV 1.4, 1.6, 1.6 16v, 1.5 dCi	(KS)	02.07			DC002A/GL					DC002P/GL	$\frac{1}{0}$
Express	(FS)	03.09 -			DC003A/GL					DC003P/GL	$\frac{1}{0}$
Pick-up	(US)	03.08 -			DC004A/GL					DC004P/GL	$\frac{1}{0}$

LOGAN II

		10.12 -								$\frac{1}{0}$	
--	--	---------	--	--	--	--	--	--	--	---------------	--

SANDERO

	(KS)	06.08 -			DC005A/GL					DC005P/GL	$\frac{1}{0}$
--	------	---------	--	--	-----------	--	--	--	--	-----------	---------------

SANDERO II

		01.13 -								$\frac{1}{0}$	
--	--	---------	--	--	--	--	--	--	--	---------------	--

DAEWOO (KO) → CHEVROLET (EU)

ESPERO

	(KLEJ)	10.91 - 09.99		OG013A	OG013A/GL				OG013P	OG013P/GL		
--	--------	---------------	--	--------	-----------	--	--	--	--------	-----------	--	--

KALOS

	(KLAS)	09.02 -			DW007AS/GL					DW007P/GL		
					DW007AD/GL							

LACETTI

	(KLAN)	02.04 -			DW009AS/GL					DW009PS/GL		
					DW009AD/GL					DW009PD/GL		

LANOS

	(KLAT)	05.97 -		OG013A	OG013A/GL		160		OG013P	OG013P/GL		50
--	--------	---------	--	--------	-----------	--	-----	--	--------	-----------	--	----

LEGANZA

	(KLAJ)	06.97 - 04.04			DW004AS/GL		180			DW004PS/GL		120
					DW004AD/GL					DW004PD/GL		

MATIZ

incl. ABS	(KLYA)	09.98 -		DW001AS	DW001AS/GL		50		DW001P	DW001P/GL		40
				DW001AD	DW001AD/GL							
		03.05 -			DW010AS/GL					DW010P/GL		
					DW010AD/GL							

NEXIA/CIELO

	(KLETN)	01.95 - 08.97		OG013A	OG013A/GL				OG013P	OG013P/GL		
--	---------	---------------	--	--------	-----------	--	--	--	--------	-----------	--	--

NUBIRA

incl. ABS	(KLAJ)	05.97 - 07.97			DW005AS/GL		200			DW005PS/GL		160
					DW005AD/GL					DW005PD/GL		
incl. ABS	(KLAJ)	08.97 - 05.99			DW006AS/GL		200			DW006PS/GL		160
					DW006AD/GL					DW006PD/GL		
incl. ABS	(KLAJ)	06.99 - 07.03			DW006AS/GL		200			DW006PS/GL		160
					DW006AD/GL					DW006PD/GL		
	(KLAN)	07.03 - 12.09			DW009AS/GL					DW009PS/GL		
					DW009AD/GL					DW009PD/GL		

TACUMA/REZZO

incl. ABS	(KLAU)	09.00 -			DW008AS/GL					DW008P/GL		
					DW008AD/GL							

TICO

	(KLY3)	02.95 - 12.00		DW003AS	DW003AS/GL				DW003P	DW003P/GL		
				DW003AD	DW003AD/GL							

OIL
GAS

OIL
GAS

DAIHATSU (J)

FEROZA/SPORTRAK 4X4

F 300 series excl. F310,	(F300)	10.88 - 12.97			DA001A/GL	$\frac{1}{0}$	85			DA001P/GL	$\frac{1}{0}$	85
F 310 serie excl.	(F310)	05.92 - 12.97			DA001A/GL	$\frac{1}{0}$	85				$\frac{1}{1}$	

FOURTRAK/ROCKY/TAFT 4X4

(F10, F20, F50, F60)	1974 - 1984		DA002A	DA002A/GL	$\frac{0}{0}$				<i>DA002P</i>		$\frac{0}{0}$	
(F25, F55, F65)	1979 - 1984		DA002A	DA002A/GL	$\frac{0}{0}$				<i>DA003P</i>		$\frac{0}{1}$	
(F70, F75, F80, F85)	1984 - 04.93			DA001P/GL	$\frac{1}{0}$					DA001P/GL	$\frac{1}{0}$	
(F77, F87)	1984 - 04.93			DA001P/GL	$\frac{1}{0}$				<i>DA003P</i>		$\frac{0}{1}$	
(F73, F78, F98)	05.93 -			<i>DA005A/GL</i>	$\frac{1}{0}$					<i>DA005P/GL</i>	$\frac{1}{0}$	

TERIOS

(J1)	10.97 - 05.00			<i>DA004AS/GL</i>						<i>DA004P/GL</i>	$\frac{0}{0}$	
				<i>DA004AD/GL</i>								
(J1)	05.00 - 10.05			<i>DA004AS/GL</i>							$\frac{0}{0}$	
				<i>DA004AD/GL</i>								

TERIOS II

(J2)	05.06 - 10.08										$\frac{0}{0}$	
------	---------------	--	--	--	--	--	--	--	--	--	---------------	--

WIDE CAB

850-1000 (S65V)	04.81 - 11.83								<i>BE001P</i>	<i>SB003A/GL</i>	$\frac{0}{0}$	
(S70, S75)	01.83 -								N.D.	<i>SK001P/GL</i>	$\frac{0}{0}$	40
									H.D.	DA002A/GL	$\frac{0}{0}$	40
4X4 (S76)	05.84 -									DA002A/GL	$\frac{0}{0}$	40



		OIL	GAS				OIL	GAS		
--	--	------------	------------	--	--	--	------------	------------	--	--

FIAT (I)

124

, , S, T	02.66 - 03.75		FI016A			40		FI022P			40
Familiare	04.67 - 03.75		FI016A			40		FI019P			40
Abarth						40		AH012P			70

125

1.6, 1.6 Special	07.67 - 03.74		<i>FI020A</i>			60		<i>FI020P</i>			
------------------	---------------	--	---------------	--	--	----	--	---------------	--	--	--

126

excl. 126 Bis	09.72 - 08.87		FI002A					FI002P			
Bis	07.87 - 09.00		FI002A					FI003P			

127

0.9, 1.0 excl. Panorama e Diesel	06.71 - 12.86		FI012A			75		FI012P			70
1.1 Sport, 1.3 Sport	07.78 - 05.83										
Panorama	01.77 - 12.86		FI012A			75		FI040P			70
Diesel	01.82 - 12.84		FI040A			75		FI040P			70

128

incl. Familiare e coupè 3P	03.69 - 12.84		FI013A	FI013A/GL		70		FI013P	FI013P/GL		70
-----------------------------	---------------	--	--------	-----------	--	----	--	--------	-----------	--	----

131

excl. Diesel → Ch. 4214186	10.74 - 02.78	1	<i>FI022A</i>			80		FI022P			70
S	10.75 - 05.78										
excl. Diesel Ch. 4214186 →	03.78 - 02.81	2	<i>FI042A</i>			80		FI022P			70
Racing	03.78 - 05.84										
excl. Diesel	03.81 - 12.83	3	<i>FI053A</i>			80		FI022P			70
Diesel → Ch. 1012810	03.78 - 09.79	4	<i>FI023A</i>			80		FI022P			70
Diesel Ch. 1012811 →	10.79 - 05.84	5	<i>FI055A</i>			80		FI022P			70
excl. Diesel → Ch. 4214186	10.74 - 02.78	1	<i>FI022A</i>			80		<i>FI032P</i>			40
excl. Diesel Ch. 4214186 →	03.78 - 02.81	2	<i>FI042A</i>			80		<i>FI032P</i>			40
excl. Diesel	03.81 - 12.83	3	<i>FI053A</i>			80		<i>FI032P</i>			40
Diesel	10.81 - 05.84	5	<i>FI055A</i>			80		<i>FI032P</i>			40
Abarth		6		AH013A		80			AH013P		70

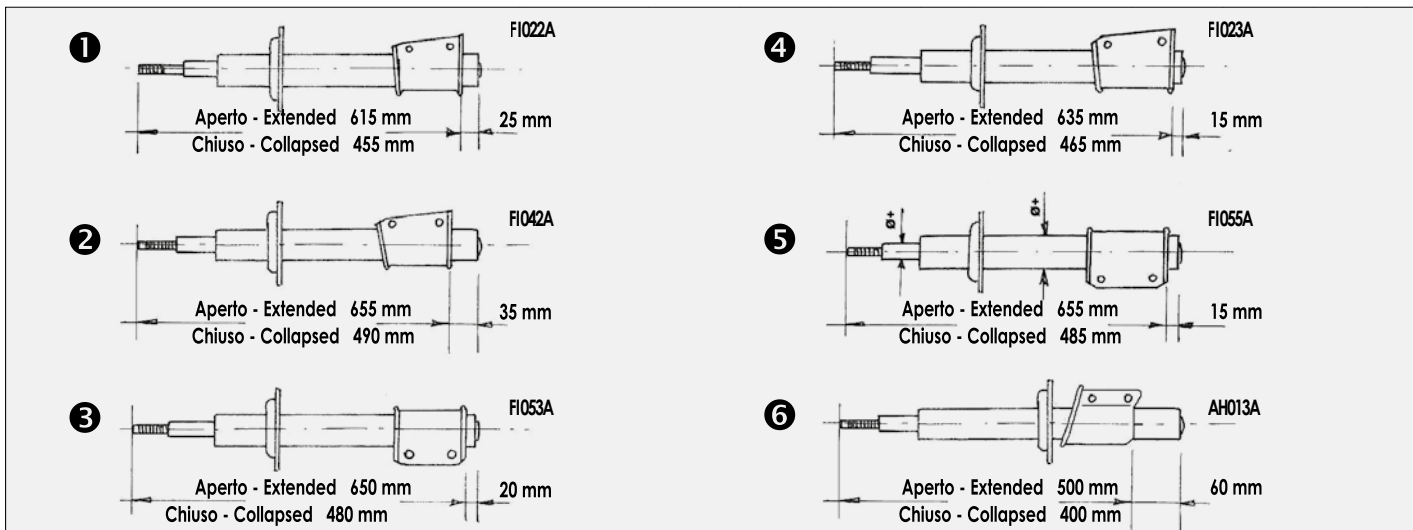

OIL
GAS

OIL
GAS

FIAT (I)

132

	04.72 - 12.82		<i>FI020A</i>		$\frac{1}{0}$	40		<i>FI021P</i>		$\frac{1}{0}$	70
--	---------------	--	---------------	--	---------------	----	--	---------------	--	---------------	----

147

(→ Ch. 359244)	10.76 - 12.95		FI040A			75		FI012P			70
(Ch. 359245 →)	10.76 - 12.95		FI040A			75		FI040P			70

238

	09.66 - 06.82		<i>FI106A</i>		$\frac{1}{0}$			<i>FI106P</i>		$\frac{0}{0}$	
--	---------------	--	---------------	--	---------------	--	--	---------------	--	---------------	--

242

	10.75 - 07.82		<i>FI108A</i>		$\frac{0}{0}$	60		<i>FI108P</i>		$\frac{0}{0}$	60
--	---------------	--	---------------	--	---------------	----	--	---------------	--	---------------	----

500

0.5, 0.6	01.57 - 01.76		FI002A		$\frac{1}{1}$	45		FI002P		$\frac{1}{1}$	45
,	10.07 -			FI344A/GL		80			FI344P/GL	$\frac{0}{0}$	30

500 L

	09.12 -	 		FI366AS/GL FI366AD/GL	 				FI366P/GL	$\frac{1}{0}$	
--	---------	------	--	--------------------------	------	--	--	--	-----------	---------------	--

600

600, 600 D	03.55 - 02.71		FI005A		$\frac{1}{1}$	60		FI005P		$\frac{1}{1}$	60
------------	---------------	--	--------	--	---------------	----	--	--------	--	---------------	----

850

850, 850 L, 850 Special	07.64 - 12.72		FI006A		$\frac{1}{1}$	60		FI006P		$\frac{1}{1}$	60
-------------------------	---------------	--	--------	--	---------------	----	--	--------	--	---------------	----

ARGENTA

	(132A) 05.77 - 03.87		<i>FI020A</i>		$\frac{1}{0}$	40		<i>FI021P</i>		$\frac{1}{0}$	70
--	----------------------	--	---------------	--	---------------	----	--	---------------	--	---------------	----

BARCETTA

	(183) 03.95 -			FI084A/GL		80			FI084P/GL	$\frac{0}{0}$	45
--	---------------	--	--	-----------	--	----	--	--	-----------	---------------	----

BRAVA/BRAVO

1.4, 1.6 (→ Ch. 4085697)	(182) 10.95 - 01.96		<i>FI064A</i>	FI064A/GL		40		<i>FI068P</i>	FI068P/GL	$\frac{0}{0}$	45
1.4, 1.6 (Ch. 4085697 →)	(182) 01.96 - 10.01		<i>FI087A</i>	FI087A/GL		40		<i>FI068P</i>	FI068P/GL	$\frac{0}{0}$	45
1.2, 1.9 D	10.95 - 10.01										
1.8	(182) 10.95 - 10.01		<i>FI088A</i>	FI088A/GL		40		<i>FI068P</i>	FI068P/GL	$\frac{0}{0}$	45
1.9 TD, 1.9 JTD	03.96 - 10.01										
2.0 20V excl.	(182) 10.95 - 10.01			FI089A/GL		40			FI068P/GL	$\frac{0}{0}$	45
	(182) 10.95 - 10.01								FI091P/GL	$\frac{0}{0}$	45



OIL

GAS



OIL

GAS



FIAT (I)

BRAVO II

excl. 1.9 150CV, 2.0 D Multijet	(198)	11.06 -	1		FI347A/GL		80			FI347P/GL		
1.9 150CV, 2.0 D Multijet	(198)	04.07 -	2		FI351A/GL		80			FI347P/GL		

1

FI347A/GL

A = 58 mm
B = 25 mm

2

FI351A/GL

A = 72 mm
B = 35 mm

CAMPAGNOLA

AR-59				FI035A						FI035P			
1107				FI036A				2x		FI036PS			
								2x		FI036PD			

CINQUECENTO

0.7, 0.8	(170)	07.91 - 01.98		FI077A	FI077A/GL		135			FI077P			40
1.1 Sporting	(170)	10.94 - 01.98			FI077A/GL		135			FI077P			40

COUPÈ

1.8 16V, 2.0 16V, 2.0 20V	(175)	11.93 - 08.00			FI080A/GL		80			FI080P/GL			25
2.0 Turbo 16V, 2.0 Turbo 20V	(175)	11.93 - 08.00			FI081A/GL		80			FI080P/GL			25

CROMA

excl. 2.0 Turbo	(154)	12.85 - 09.86			LN019A/GL		70			LN019P/GL		130
excl. 2.0 Turbo	(154)	10.86 - 12.96			LN019A/GL		70	excl.		LN027P/GL		130
excl. 2.0 Turbo	(154)	12.85 - 09.86			LN019A/GL		70			LN019P/GL		130
excl. 2.0 Turbo	(154)	10.86 - 12.96			LN019A/GL		70	excl.		LN027P/GL		130
2.0 Turbo	(154)	12.85 - 09.86			LN019A/GL		70			LN019P/GL		130
2.0 Turbo	(154)	10.86 - 12.96			LN019A/GL		70	excl.		LN027P/GL		130
2.0 Turbo	(154)	12.85 - 09.86			LN019A/GL		70			LN019P/GL		130
2.0 Turbo	(154)	10.86 - 12.96			LN019A/GL		70	excl.		LN027P/GL		130

CROMA II

excl.	(194)	06.05 -			OG049AS/GL			excl.		OG049P/GL		
excl.	(194)	06.05 -			OG050AS/GL			excl.		OG050P/GL		

OIL
GAS

OIL
GAS

FIAT (I)

DOBLÒ

, excl.	(119)	12.00 -		<i>FI329A</i>	FI329A/GL		110		<i>FI329P</i>	FI329P/GL		50
CARGO excl.	(223)	12.00 -		<i>FI329A</i>	FI329A/GL		110		<i>FI329P</i>	FI329P/GL		50

DOBLÒ II

, Furgonato	(263)	02.10 -			FI352AS/GL FI352AD/GL					FI352P/GL		40
Combi (trasporto persone)	(152, 263)	02.10 -			FI352AS/GL FI352AD/GL					FI367P/GL		40

DOGAN / SAHIN

(Made in Egypt)				<i>FI129A</i>	FI129A/GL		80		<i>FI021P</i>			70
-----------------	--	--	--	---------------	-----------	--	----	--	---------------	--	--	----

DUCATO

10-13Q	(280)	01.82 - 04.84		FI143A			150	1	FI143P			45
Panorama		07.82 - 04.84	3	FI143A			150	2	FI304P			45
10Q 1000 Kg, 14Q 1400 Kg	(280, 290)	04.84 - 03.94		FI304A			150	1	FI143P			45
Panorama		04.84 - 03.94	3	FI304A			150	3	FI300P			45
Maxi 18Q 1800 Kg	(280, 290)	04.84 - 03.94		FI300A			150					
4X4		04.84 - 03.94	3	FI304A			150					
, excl. 4X4	(280, 290)	04.84 - 03.94		FI304A			150					
Express 10 - 13 - 15	(280, 290)	04.84 - 03.94		FI304A			150	1	FI143P			45
			3					2	FI304P			45
1000 Kg, 1400 Kg	(230)	01.94 - 04.02		FI320A	FI320A/GL		170	4	FI320P	FI320P/GL		45
1800 Kg	(230)	01.94 - 04.02		FI322A	FI322A/GL		170	5	FI322P	FI322P/GL		45
Camping Car	(230)	01.94 - 08.95		FI322A	FI322A/GL		170					
Grand Export		01.94 - 08.95	9									
Camping Car	(230)	09.95 - 04.02		FI322A	FI322A/GL		170					
Grand Export		09.95 - 04.02	9									
1000 Kg, 1400 Kg	(244)	04.02 - 05.06	9	FI320A	FI320A/GL			4	FI320P	FI320P/GL		
1800 Kg	(244)	04.02 - 05.06	9	FI322A	FI322A/GL			5	FI322P	FI322P/GL		
1000Kg 1400Kg	(250)	04.06 -	1 10		FI340A/GL			6		FI341P/GL		
1400Kg 2000Kg	(250)	04.06 -	1 10		FI341A/GL			7		FI343P/GL		
1000Kg 1400Kg	REINFORCED (250)	04.06 -	2 10		FI341A/GL			6		FI341P/GL		
1400Kg 2000Kg	REINFORCED (250)	04.06 -	2 10		FI342A/GL			7		FI343P/GL		

	1	2	3	4	5	6	7
	FI143P	FI304P	FI300P	FI320P/GL	FI322P/GL	FI341P/GL	FI343P/GL
	A = 10 mm.	A = 16 mm.	A = 10 mm.	A = 16 mm.	A = 16 mm.	A = 16 mm.	A = 16 mm.
	B = 16 mm.	B = 10 mm.	B = 16 mm.	B = 16 mm.	B = 16 mm.	B = 16 mm.	B = 16 mm.
	La = 570 mm.	La = 535 mm.	La = 590 mm.	La = 490 mm.	La = 470 mm.	La = 465 mm.	La = 455 mm.
	Lc = 360 mm.	Lc = 342 mm.	Lc = 367 mm.	Lc = 320 mm.	Lc = 300 mm.	Lc = 300 mm.	Lc = 315 mm.

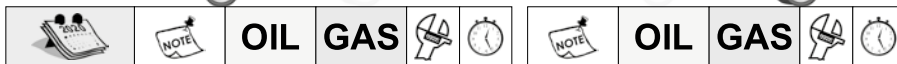

FIAT (I)

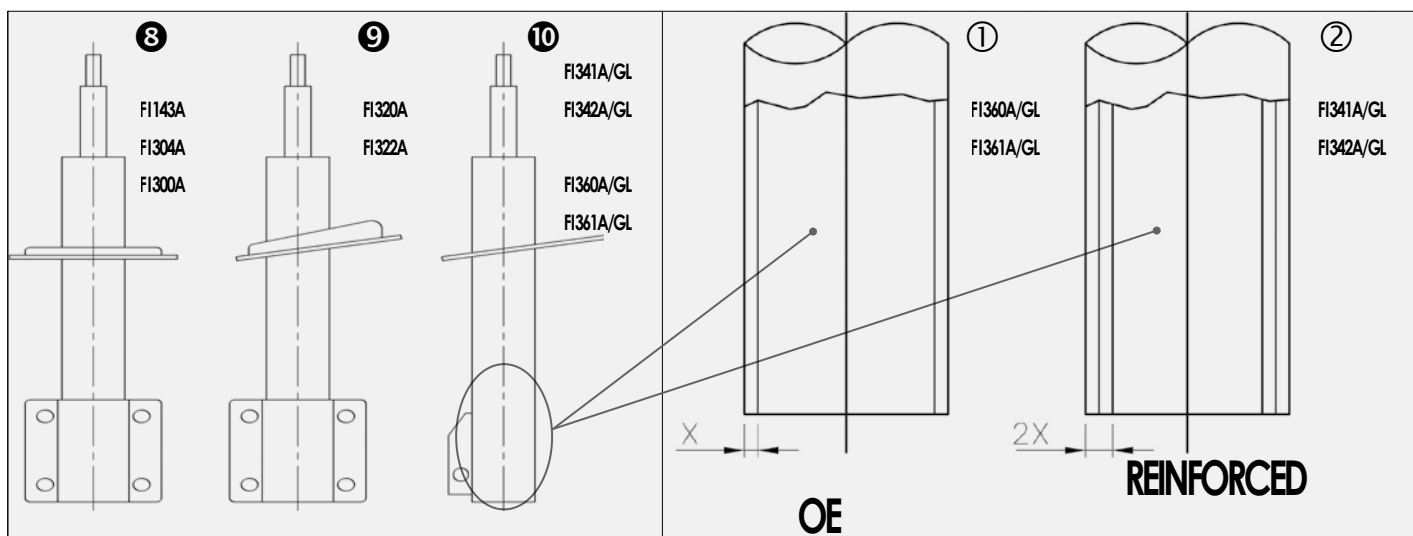

DUNA/CITY VAN/PENNY/PREMIO

	(146B)	01.87 - 12.91		FI063A		90		FI063P		70
Weekend, Panorama, Van	(146B)	01.87 - 12.91		FI063A		90		FI063P		70

FIORINO

, → Ch. 7017071 (Made in Europe)	(127)	10.77 - 06.82		FI012A		75		FI012P		70	
, Ch. 7017072 → (Made in Europe)	(127)	07.82 - 12.84		FI012A		75		FI040P		60	
, (Made in Brazil)	(127)	07.82 - 12.87		FI040A		70		FI040P		60	
, (Made in Brazil)	(127)	01.87 - 12.88		FI063A		70		FI063P		60	
, (Made in Brazil) Ch. 8000001 → 8149536	(146, 147)	01.88 - 12.90		FI063A		70		FI069P		60	
, (Made in Brazil) Ch. 8149537 →	(146, 147)	01.91 - 07.93		FI083A		80		FI069P		60	
, (Made in Brazil)	(146, 147)	08.93 - 05.01		FI083A		80		FI083P	FI083P/GL		30
excl. Natural power N.D. Finestrato	(225)	02.08 -			FI350AS/GL FI350AD/GL				FI350P/GL		
excl. Natural power H.D. Cassonato	(225)	02.08 -			FI350AS/GL FI350AD/GL				FI364P/GL		

FREEMONT

	(JC)	08.11 -			FI359AS/GL FI359AD/GL				FI359P/GL		
--	------	---------	--	--	--------------------------	--	--	--	-----------	--	--

IDEA

1.2 16V, 1.4 16V	(135)	01.04 -			LN047A/GL		60		LN047P/GL		40
1.3 JTD, 1.9 JTD	(135)	01.04 -			LN048A/GL		60		LN047P/GL		40

LINEA

	(323)	06.07 -			FI337AS/GL FI337AD/GL				FI337P/GL		
--	-------	---------	--	--	--------------------------	--	--	--	-----------	--	--

OIL
GAS

OIL
GAS

FIAT (I)

MAREA

Weekend 1.2, 1.4, 1.6, 1.8	(185)	09.96 - 05.02			FI091A/GL		85		<i>FI068P</i>	FI068P/GL		45
Weekend 1.9 TD, 1.9 JTD		09.96 - 05.02										
Weekend 2.0	(185)	09.96 - 05.02			FI092A/GL		85			FI091P/GL		45
Weekend 2.4 TD, 2.4 JTD		09.96 - 05.02										

MULTIPLA

excl. Bipower, blupower	(186)	04.99 - 06.10			FI100A/GL		80			FI090P/GL		25
Bipower, blupower	(186)	04.99 - 06.10			FI321A/GL		80			FI090P/GL		25

PALIO/SIENA

	(178BX)	04.96 - 02.01		<i>FI098A</i>	FI098A/GL		80			FI098P/GL		50
Weekend	(178DX)	04.96 - 02.01		<i>FI101A</i>	<i>FI101A/GL</i>		80					
Weekend				<i>FI098A</i>	FI098A/GL		80		<i>FI068P</i>	FI068P/GL		25
		03.01 -		<i>FI101A</i>	<i>FI101A/GL</i>		80					
		03.01 -			FI339A/GL		80			FI098P/GL		50
Weekend		03.01 -			FI339A/GL		80		<i>FI068P</i>	FI068P/GL		25

PANDA I

excl. 4X4	(141A)	03.80 - 02.86		ACC45	FI048A	FI048A/GL		70		FI037P		30	
excl. 4X4	(141A)	03.86 - 09.03		ACC45	FI048A	FI048A/GL		70		AB006P	AB006P/GL		30
4X4	(141A)	09.83 - 07.04		ACC45	<i>FI049A</i>	FI049A/GL		70		FI049P	FI049P/GL		30
4x4 Rialzata	(141A)	09.83 - 07.04		ACC45	FI094A	FI094A/GL				FI049P	FI049P/GL		

PANDA II

excl. 4X4, easy power, natural power, van	(169)	09.03 -			FI335AS/GL		80			FI335P/GL		40
4x4	(169)	09.03 -			FI335AD/GL		80					
4x4	(169)	09.03 -			FI336AS/GL		80			FI336P/GL		40
4x4	(169)	09.03 -			FI336AD/GL		80					
Van	(169)	09.03 -			FI335AS/GL		80			FI335P/GL		40
Van	(169)	09.03 -			FI335AD/GL		80					
1.2 Easy power (Gpl)	(169)	01.07 -			FI362AS/GL		80			FI336P/GL		40
1.4 Easy power (Gpl)	(169)	09.10 -			FI362AD/GL		80					
1.2 Natural power (Metano)	(169)	01.07 -			FI358AS/GL		80			FI368P/GL		40
1.4 Natural power (Metano)	(169)	09.10 -			FI358AD/GL		80					
4x4 Rialzata	(169)	09.03 -			FI349AS/GL		100		5	FI349P/GL		40
4x4 Rialzata	(169)	09.03 -			FI349AD/GL		100					

- 5**
- ① Ammortizzatore allungato da installare esclusivamente con la molla di carico 10883 o 10884
 - Ⓜ Extended shock absorber to install exclusively with auxiliary spring 10883 or 10884
 - ⓕ Ammortiseur allongé de installer avec ressort compensateurs 10883 ou 10884
 - ⓓ Verlängertstoßdämpfer installations ausschließlich mit nivellierungsfedersätze 10883 oder 10884
 - ⓔ Amortiguador prolongado da instalar con la muella compesadora 10883 o 10884
 - Ⓟ Amortecedor alongado para instalar com mola de carga 10883 ou 10884

FIAT (I)

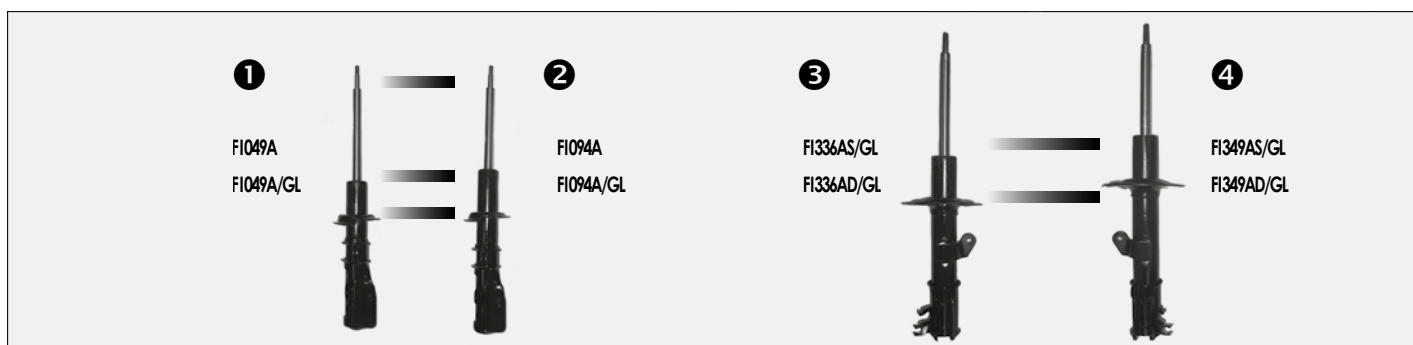

PANDA III

incl. LPG, excl. 4X4	(312)	02.12 -			FI363AS/GL FI363AD/GL				FI363P/GL		
4X4, Natural power	(312)	06.12 -			FI369AS/GL FI369AD/GL				FI369P/GL		

PUNTO I

1.1, 1.2, 1.6, 1.7 D	(176)	11.93 - 09.99		ACC60	FI078A	FI078A/GL		85		<i>FI078P</i>	FI078P/GL		50
1.2, 1.6	(176C)	04.94 - 06.00											
1.4 Turbo GT	(176)	01.94 - 09.99				FI079A/GL		85		<i>FI078P</i>	FI078P/GL		50
1.7 TD	(176)	01.94 - 09.99		ACC60	<i>FI079A</i>	FI079A/GL		85		<i>FI078P</i>	FI078P/GL		50

PUNTO II

1.2, 1.2 16V, 1.4, 1.3 JTD excl.	(188)	09.99 -				FI324A/GL		85			FI324P/GL		50
1.9 D, 1.9 JTD	(188)	09.99 -				FI325A/GL		85			FI324P/GL		50
1.2 16V Sporting		09.99 -				FI326A/GL		85			FI326P/GL		50
1.8 16V HGT	(188)	09.99 -											

PUNTO III (GRANDE PUNTO)

incl. Natural power	(199)	10.05 -				FI337AS/GL FI337AD/GL		70			FI337P/GL		50
---------------------	-------	---------	--	--	--	--------------------------	--	----	--	--	-----------	--	----

PUNTO EVO

	(199)	07.08 - 02.12				FI353AS/GL FI353AD/GL		70			FI353P/GL		50
--	-------	---------------	--	--	--	--------------------------	--	----	--	--	-----------	--	----

QUBO

excl. Natural power N.D. Finestrato	(255)	02.08 -				FI350AS/GL FI350AD/GL					FI350P/GL		
--	-------	---------	--	--	--	--------------------------	--	--	--	--	-----------	--	--

REGATA

	(138)	09.83 - 12.90		ACC43	FI050A			70		FI028P	<i>FI028P/GL</i>		70
Weekend	(138)	01.84 - 06.91		ACC43	FI050A			70		<i>FI060P</i>	<i>FI060P/GL</i>		70

OIL
GAS

OIL
GAS

FIAT (I)

RITMO I / STRADA

excl. 125 TC	(138A, 178E)	01.78 - 10.82	ACC21	FI028A	FI028A/GL		70		FI028P	FI028P/GL		70
125 TC	(138A, 178E)	11.81 - 10.82		FI059A	FI059A/GL		70		FI028P	FI028P/GL		70
excl. Abarth	(138A, 178E)	11.82 - 12.88	ACC43	FI050A			70		FI028P	FI028P/GL		70
Abarth 125, 130 TC	(138A, 178E)	11.82 - 12.88			FI047A/GL		70		FI028P	FI028P/GL		70

SCUDO

(→ Ch. 7609)	(220L, 220P)	02.96 - 09.97		FI082A			90	4	FI082P	FI082P/GL		45
(Ch. 7610 → 9793)	(220L, 220P)	09.97 - 10.03		FI082A			90	5		LN042P/GL		45
(Ch. 9794 → 10408)		10.03 - 05.04			CI026AS/GL CI026AD/GL			5		LN042P/GL		45
(Ch. 10409 →)		05.04 - 02.07		FI082A				5		LN042P/GL		45
1.6D, 2.0 D excl H.D.	(272)	01.07 -			FI345AS/GL FI345AD/GL			6		FI345P/GL		50
1.6D, 2.0 D H.D.	(272)	01.07 -			FI346AS/GL FI346AD/GL			7		FI346P/GL		50

	4	FI082P / FI082P / GL A = 12 mm. B = 12 mm. La = 380 mm. Lc = 270 mm.	5	LN042P / GL A = 12 mm. B = 12 mm. La = 400 mm. Lc = 283 mm.	6	FI345P / GL A = 12 mm. B = 14 mm. La = 395 mm. Lc = 280 mm.	7	FI346P / GL A = 12 mm. B = 14 mm. La = 395 mm. Lc = 280 mm.
--	----------	---	----------	--	----------	--	----------	--

SEDICI

1.6 ie	06.06 -			FI338AS/GL FI338AD/GL					FI338P/GL		
1.9 JTD	06.06 -			FI348AS/GL FI348AD/GL					FI348P/GL		

SEICENTO

excl. Sporting	(187)	01.98 - 01.10	ACC42	FI077A	FI077A/GL		80		FI077P			40
Van												
Sporting	(187)	01.98 - 01.10	ACC42		FI077A/GL		80		FI077P			40

STILO

1.2, 1.6	(192)	09.01 - 11.06	3		FI330A/GL		90			FI330P/GL		45
1.8, 1.9 JTD	(192)	09.01 - 11.06	3		FI331A/GL		90			FI330P/GL		45
2.4 20V, GT Abarth	(192)	09.01 - 11.06	3		FI332A/GL		90			FI330P/GL		45
Multiwagon 1.6	(192)	01.03 - 08.08	3		FI330A/GL		90			FI334P/GL		45
Multiwagon 1.8, 1.9 JTD	(192)	01.03 - 08.08	3		FI331A/GL		90			FI334P/GL		45
1.9 JTD 140CV	(192)	01.04 -			FI351A/GL		90			FI330P/GL		45
1.9D Multijet 150CV		09.05 -										

OIL
GAS

OIL
GAS

FIAT (I)



STRADA

	(178E)	06.99 -		<i>FI098A</i>	FI098A/GL		100		FI083P	FI083P/GL		50
	1.2, 1.9 JTD	(278)	06.99 -	OE 51791061	FI339A/GL		100		FI083P	FI083P/GL		50

TALENTO

	(290)	03.89 - 03.94	ACC100	FI304A			150	1	FI143P			45
	(290)	03.89 - 03.94	ACC100	FI304A			150	2	FI304P			45

TEMPRA

	1.4, 1.6, 1.9 D	(159)	03.90 - 08.97	ACC78	<i>FI064A</i>	FI064A/GL		70		<i>FI071P</i>	FI071P/GL		45
	1.8, 2.0, 1.9 TD	(159)	03.90 - 08.97	ACC49	<i>FI068A</i>	FI068A/GL		70		<i>FI071P</i>	FI071P/GL		45
	SW 1.4, 1.6, 1.9 D excl. 4X4,	(159)	03.90 - 08.97	ACC78	<i>FI064A</i>	FI064A/GL		70	excl.		FI071P/GL		45
	SW 1.8, 2.0, 1.9 TD excl. 4X4,	(159)	03.90 - 08.97	ACC49	<i>FI068A</i>	FI068A/GL		70	excl.		FI071P/GL		45
	SW	(159)	03.90 - 08.97	ACC49	<i>FI068A</i>	FI068A/GL		70					
	SW 4X4	(159)	03.90 - 08.97	ACC49	<i>FI068A</i>	FI068A/GL		70			FI091P/GL		45

1 2

- I** Vedi disegno/nota Fiat Ducato a pagina 40
- GB** See drawing/note Fiat Ducato on page 40
- F** Voir plan/note Fiat Ducato à la page 40
- D** Siehe Fiat Ducato Zeichnung/Anmerkung auf Seite 40
- E** Ver dibujo/anotación Fiat Ducato a la página 40
- P** Ver figura/nota Fiat Ducato na página 40

TIPO

	1.1, 1.4, 1.6	(160)	07.87 - 04.95	ACC78	<i>FI064A</i>	FI064A/GL		70		<i>FI071P</i>	FI071P/GL		45
	1.7D, 1.9 D												
	1.8, 1.8 16V, 2.0, 2.0 16V	(160)	07.87 - 04.95	ACC49	<i>FI068A</i>	FI068A/GL		70		<i>FI068P</i>	FI068P/GL		45
	1.9 TD												

OIL
GAS

OIL
GAS

FIAT (I)

ULYSSE I

(→ Ch. 7609)	(220)	03.94 - 12.97			FI082A/GL		90	4	<i>FI082P</i>	FI082P/GL		45
(Ch. 7610 →)	(220)	01.98 - 08.02			FI082A/GL		90	5		LN042P/GL		45

4 5	<p>I Vedi disegno/nota Fiat Scudo a pagina 44</p> <p>GB See drawing/note Fiat Scudo on page 44</p> <p>F Voir plan/note Fiat Scudo à la page 44</p> <p>D Siehe Fiat Scudo Zeichnung/Anmerkung auf Seite 44</p> <p>E Ver dibujo/anotación Fiat Scudo a la página 44</p> <p>P Ver figura/nota Fiat Scudo na página 44</p>
------------	--

ULYSSE II

	(179AX)	08.02 - 06.11			LN049AS/GL LN049AD/GL		100			LN049P/GL		
--	---------	---------------	--	--	--------------------------	--	-----	--	--	-----------	--	--

UNO

excl. Turbo	(146A/E)	01.83 - 12.96		FI043A	FI043A/GL		80		FI043P	FI043P/GL		50
1.3 Turbo, 1.4 Turbo	(146A/E)	01.83 - 12.96			FI043A/GL		80			FI043P/GL		50

UNO (CS)

(Made in Brazil)	(CS)	01.88 - 12.91		FI063A			90		FI063P			70
------------------	------	---------------	--	--------	--	--	----	--	--------	--	--	----

X 1/9

1.3	(128AS)	11.72 - 12.79		<i>FI029A</i>			90		<i>FI029P</i>			90
1.5 Europa	(128AS)	11.78 - 12.89		<i>FI029A</i>			90		<i>FI058P</i>			90
1.5 USA	(128AS)			<i>FI029A</i>			90		<i>FB27P</i>			90

OIL
GAS

OIL
GAS

FORD (EUR)

B-MAX

	10.12 -													
--	---------	--	--	--	--	--	--	--	--	--	--	--	--	--

C-MAX

	02.07 -			FR077AS/GL					FR077P/GL					
				FR077AD/GL										
	12.10 -			FR085AS/GL					FR077P/GL					
				FR085AD/GL										

COUGAR

	(EC)	08.98 - 12.01			FR057A/GL					FR069P/GL				
--	------	---------------	--	--	-----------	--	--	--	--	-----------	--	--	--	--

ESCORT III/IV (80-90)

	excl. XR3	(GAA, AWA)	09.80 - 08.81		FR017A	FR017A/GL		60		FR017P	FR017P/GL		55
	excl. XR3	(GAA, AWA)	09.81 - 05.83		FR017A	FR017A/GL		60		FR017P	FR017P/GL		55
	excl. 1.6 D, XR3	(GAF, AWF, AVF, ABFT)	06.83 - 11.84		FR020A	FR020A/GL		60		FR017P	FR017P/GL		55
	excl. 1.6 D, XR3	(GAF, AWF, AVF, ABFT)	12.84 - 01.86		FR020A	FR020A/GL		60		FR017P	FR017P/GL		55
	excl. 1.6 D, XR3i, RS	(GAF, AWF, AVF, ABFT)	01.86 - 07.90		FR020A	FR020A/GL		60		FR017P	FR017P/GL		55
	1.6 D	(GAF, AWF, AVF, ABFT)	06.83 - 11.84		FR023A	FR023A/GL		60		FR017P	FR017P/GL		55
	1.6 D	(GAF, AWF, AVF, ABFT)	12.84 - 01.86		FR023A	FR023A/GL		60		FR017P	FR017P/GL		55
	1.6 D	(GAF, AWF, AVF, ABFT)	02.86 - 07.90		FR023A	FR023A/GL		60		FR017P	FR017P/GL		55
	1.6 XR3i	(GAF, AWF, AVF, ABFT)	10.82 - 05.83								FR017P/GL		55
	1.6 XR3i	(GAF, AWF, AVF, ABFT)	06.83 - 11.84			FR020A/GL		60			FR017P/GL		55
	1.6 XR3i	(GAF, AWF, AVF, ABFT)	12.84 - 07.90			FR020A/GL		60			FR017P/GL		55
	1.6 RS Turbo	(GAF, AWF, AVF, ABFT)	06.83 - 11.84			FR020A/GL		60			FR017P/GL		55
	1.6 RS Turbo	(GAF, AWF, AVF, ABFT)	12.84 - 01.86			FR020A/GL		60			FR017P/GL		55
		(ALD)	06.83 - 11.84		FR020A	FR020A/GL		60		FR017P	FR017P/GL		55
	excl. XR3i	(ALF)	12.84 - 07.90		FR020A	FR020A/GL		60		FR017P	FR017P/GL		55
	1.6 XR3i	(ALD)	06.83 - 11.84			FR020A/GL		60			FR017P/GL		55
	1.6 XR3i	(ALF)	12.84 - 07.90			FR020A/GL		60			FR017P/GL		55
	35, 55	(AVA)	01.81 - 05.83							FR042P			40
	35, 55	(AVA)	06.83 - 11.84		FR042A					FR042P			40
	35, 55	(AVF)	12.84 - 09.90		FR042A					FR042P			40

OIL
GAS

OIL
GAS

FORD (EUR)

ESCORT V/VI (90-95)

1.1, 1.3 (GAL)	08.90 - 01.95	1	FR034A	FR034A/GL		90		FR033P	FR033P/GL		45
1.4	08.90 - 10.90										
1.4 (GAL)	10.90 - 01.95	2	FR033A	FR033A/GL		90		FR033P	FR033P/GL		45
1.6	08.90 - 01.95										
1.4i, 1.6i (GAL)	08.90 - 01.95	2	FR033A	FR033A/GL		90		FR033P	FR033P/GL		45
1.8i (GAL)	01.92 - 01.95	2	FR033A	FR033A/GL		90		FR033P	FR033P/GL		45
excl.											
1.8i (GAL)	01.92 - 01.95	2	FR033A	FR033A/GL		90		FR033P	FR033P/GL		45
1.8 D (GAL)	08.90 - 10.90	1	FR034A	FR034A/GL		90		FR033P	FR033P/GL		45
1.8 D, 1.8 TD (GAL)	11.90 - 01.95	2	FR033A	FR033A/GL		90		FR033P	FR033P/GL		45
1.8 16V XR3i (GAL)	02.92 - 01.95	2		FR033A/GL		90			FR033P/GL		45
RS 2000 4X2 (GAL)	09.92 - 01.95		<i>FR037A</i>			90		<i>FR037P</i>			45
RS Turbo 4x4 excl. Cosworth (GAL)	08.93 - 01.95		<i>FR037A</i>			90					
RS Cosworth 4x4 (GAL)	09.92 - 01.95		<i>FR043A</i>								
1.4 (GAL, AVL)	08.90 - 10.90	1	FR034A	FR034A/GL		90	4	FR034P	FR034P/GL		45
1.4 (GAL, AVL)	10.90 - 01.95	2	FR033A	FR033A/GL		90	4	FR034P	FR034P/GL		45
1.4i, 1.6, 1.6i, 1.6i 16V	08.90 - 01.95										
1.8i	01.92 - 01.95										
1.8 D (GAL, AVL)	08.90 - 10.90	1	FR034A	FR034A/GL		90	4	FR034P	FR034P/GL		45
1.8 D, 1.8 TD (GAL, AVL)	10.90 - 01.95	2	FR033A	FR033A/GL		90	4	FR034P	FR034P/GL		45
(ALL)	12.92 - 01.95	2		FR033A/GL		90			FR033P/GL		45
500 kg (AVL)	07.90 - 12.94	1	FR034A	FR034A/GL		90		FR041P			45
700 kg (AVL)	07.90 - 12.94	2	FR041A	FR041A/GL		90		FR041P			45

ESCORT VII (95-00)

1.3i (GAL, AAL, ABL, AFL)	01.95 - 02.99	3	<i>FR050A</i>	FR050A/GL				<i>FR050P</i>	FR050P/GL		45
1.4i, 1.6i (GAL, AAL, ABL, AFL)	01.95 - 02.99	3	<i>FR050A</i>	FR050A/GL				<i>FR050P</i>	FR050P/GL		45
1.6i 16V, 1.8i, 1.8i 16V (GAL, AAL, ABL, AFL)	01.95 - 02.99	3	<i>FR050A</i>	FR050A/GL				<i>FR050P</i>	FR050P/GL		45
excl. 4X4											
1.8 D, 1.8 TD (GAL, AAL, ABL, AFL)	01.95 - 02.99	3	<i>FR050A</i>	FR050A/GL				<i>FR050P</i>	FR050P/GL		45
RS 2000 16V 4X2 (GAL, AAL, ABL, AFL)	01.95 - 02.99	3	<i>FR045A</i>								
excl. 4X4											
1.6i 4x4 (GAL, AAL, ABL, AFL)	01.95 - 10.98		<i>FR049A</i>								
RS 2000 4x4 excl. Cosworth	01.95 - 10.98										
Clipper 1.3i (GAL, ANL)	08.95 - 02.99	1	FR034A	FR034A/GL		90	4	FR046P	FR046P/GL		45



ANTERIORE
FRONT

POSTERIORE
REAR



OIL

GAS



OIL

GAS



FORD (EUR)

ESCORT VII (95-00)

Clipper 1.4i, 1.6i, 1.6i 16V, 1.8i, 1.8i 16V (GAL, ANL)	01.95 - 08.95	③	<i>FR050A</i>	FR050A/GL			④	FR034P	FR034P/GL		45
Clipper 1.8 D, 1.8 TD	01.95 - 08.95										
Clipper 1.4i, 1.6i, 1.6i 16V, 1.8i, 1.8i 16V (GAL, ANL)	08.95 - 02.99	③	<i>FR050A</i>	FR050A/GL			④	FR046P	FR046P/GL		45
Clipper 1.8 D, 1.8 TD	08.95 - 02.99										
(ALL)	01.95 - 08.00	③	<i>FR050A</i>	FR050A/GL				<i>FR050P</i>	FR050P/GL		45
500 kg (AVL)	01.95 -	③	<i>FR064A</i>	FR050A/GL				FR041P			45
700 kg (AVL)	01.95 -	③	<i>FR064A</i>	FR050A/GL				FR041P			45

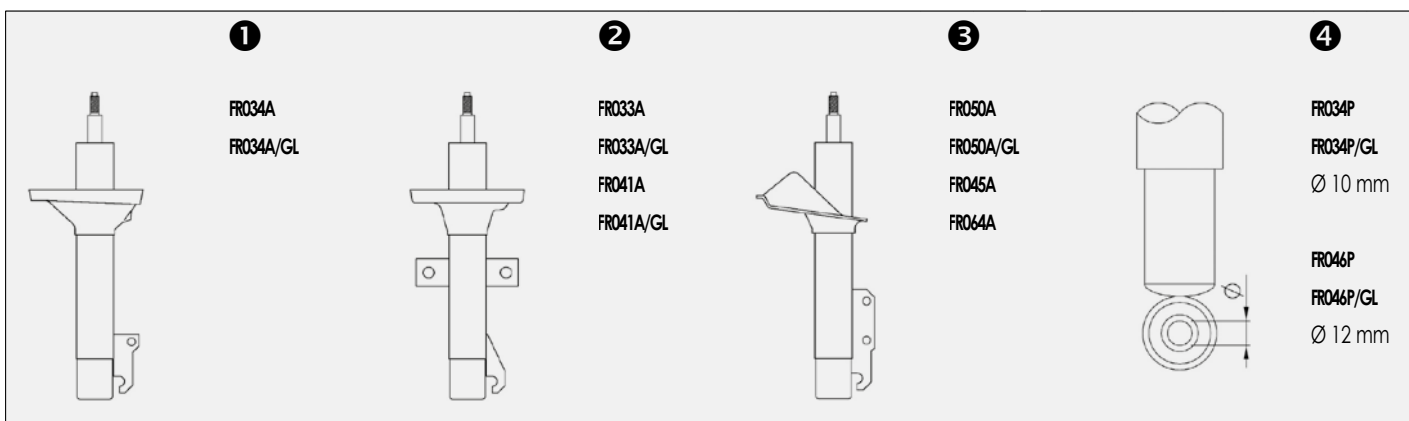

EXPLORER

(U2)	01.91 - 10.94									
(U2)	11.94 -									

FIESTA I

excl. XR2 (GFBT)	05.76 - 08.83		FR016A			120		FR016P	<i>FR016P/GL</i>		50
XR2 (GFBT)	1981 - 08.83		FR039A			120		FR039P			50

FIESTA II

excl. XR2 (FBD)	09.83 - 11.84		ACC69	FR021A	<i>FR021A/GL</i>		120		FR016P	<i>FR016P/GL</i>		50
excl. XR2 (FBD)	12.84 - 12.88		ACC69	FR021A	<i>FR021A/GL</i>		120		FR016P	<i>FR016P/GL</i>		50
XR2 (FBD)	09.83 - 11.84		ACC69	<i>FR063A</i>			120		FR063P			50
XR2 (FBD)	12.84 - 02.89		ACC69	<i>FR063A</i>			120		FR063P			50

FIESTA III

1.0, 1.1, 1.3, 1.4, 1.6, 1.8 D (GFJ)	01.89 - 12.93	⑤	ACC69	FR027A	FR027A/GL		120		FR027P	FR027P/GL		50
1.4 S, 1.6 S, 1.8 Si, 1.8 D, 1.8 TD (GFJ)	01.89 - 12.93	⑥	ACC69	FR035A	FR035A/GL		120		FR027P	FR027P/GL		50
1.6 XR2i, 1.8 16V XR2i, RS 1800 (GFJ)	01.89 - 12.93	⑥	ACC69		FR035A/GL		120			FR027P/GL		50
1.6 Turbo (GFJ)	03.90 - 12.93	⑥	ACC69		FR035A/GL		120			<i>FR029P/GL</i>		50
excl. Courier (GFJ)	01.89 - 12.93	⑤	ACC69	FR027A	FR027A/GL		120		FR027P	FR027P/GL		50
1.1, 1.3, 1.4 C, CLX, Ghia, Youth Senza barra stabilizzatrice - without stabilizer (GFJ)	01.94 - 12.95	⑤	ACC69	FR048A	FR048A/GL		120		FR048P	FR048P/GL		50



OIL

GAS



OIL

GAS



FORD (EUR)

FIESTA III

1.1, 1.3, 1.4 C, CLX, Ghia, Youth Con barra stabilizzatrice - with stabilizer	(GFJ)	01.94 - 12.95	6 ACC69	FR048A	FR048A/GL		120		FR048P	FR048P/GL		50
1.1, 1.3 SX 1.4 Si, SX, Futura 1.6	(GFJ)	01.94 - 12.95 01.94 - 12.95 01.94 - 12.95	6 ACC69	FR048A	FR048A/GL		120		FR048P	FR048P/GL		50
1.6 LX, Si, Futura		01.94 - 12.95			FR047A/GL					FR047P/GL		
1.8 D Senza barra stabilizzatrice - without stabilizer	(GFJ)	01.94 - 12.95	5 ACC69	FR048A	FR048A/GL		120		FR048P	FR048P/GL		50
1.8 TD	(GFJ)	01.94 - 12.95	6 ACC69	FR048A	FR048A/GL		120		FR048P	FR048P/GL		50
XR2i, RS 1800 Con barra stabilizzatrice - with stabilizer		01.94 - 12.95			FR047A/GL					FR047P/GL		
excl. Fiesta Courier	(GFJ)	01.94 - 12.95	6 ACC69	FR048A	FR048A/GL		120		FR048P	FR048P/GL		50

FIESTA III CLASSIC

1.1, 1.3, 1.4, 1.8 D	(GFJ)	12.95 - 12.97	5 ACC69	FR048A	FR048A/GL		120		FR048P	FR048P/GL		50
1.1, 1.3, 1.4, 1.6, 1.8 TD	(GFJ)	12.95 - 12.97	6 ACC69	FR048A	FR048A/GL		120		FR048P	FR048P/GL		50
1.6 LX, Si, Futura	(GFJ)	12.95 - 12.97			FR047A/GL					FR047P/GL		

FIESTA IV

1.0, 1.25, 1.3 16V, 1.4 16V excl. Fiesta Classic	(JA, JB)	08.95 - 10.98		FR051A	FR051A/GL		120	7	FR051P	FR051P/GL		50
1.0, 1.25, 1.3 16V	(JA, JB)	11.98 - 12.01		FR051A	FR051A/GL		120	8	FR066P	FR066P/GL		
1.4 16V, 1.6	(JA, JB)	11.98 - 12.01		FR051A	FR051A/GL		120	7	FR051P	FR051P/GL		
1.8 D, 1.8 DI excl. Fiesta Classic	(JA, JB)	08.95 - 10.98		FR052A	FR052A/GL		120	7	FR051P	FR051P/GL		
1.8 D, 1.8 DI	(JA, JB)	11.98 - 12.01		FR052A	FR052A/GL		120	8	FR066P	FR066P/GL		

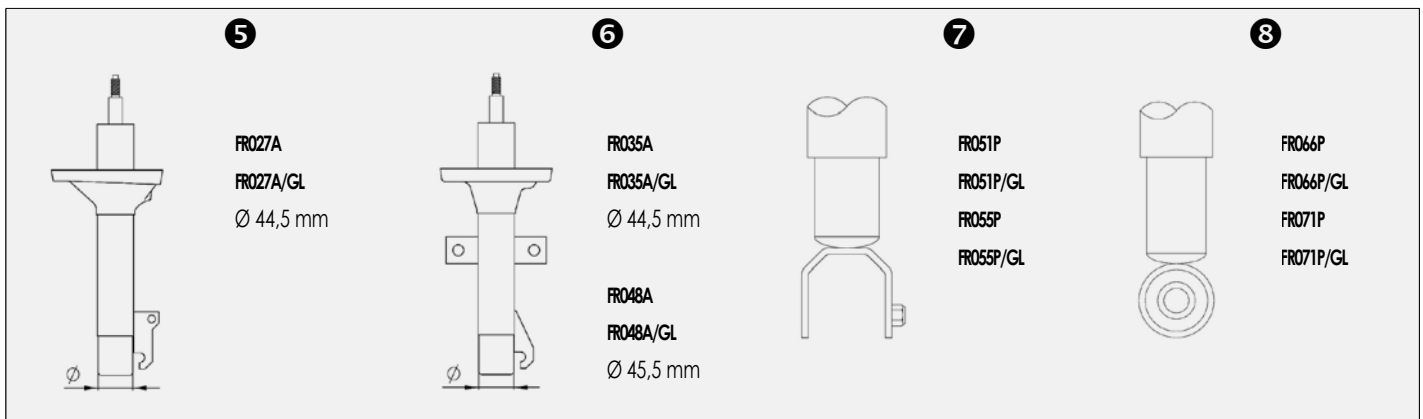



		OIL	GAS				OIL	GAS		
--	--	------------	------------	--	--	--	------------	------------	--	--

FORD (EUR)

FIESTA V

excl. ST150	(JH, JD)	11.01 - 12.03	 	<u>FR075AS</u> <u>FR075AD</u>	FR075AS/GL FR075AD/GL	 		<u>FR075P</u> <u>FR075P/GL</u>	 	
excl. ST150	(JH, JD)	01.04 -	 	<u>FR080AS</u> <u>FR080AD</u>	FR080AS/GL FR080AD/GL	 		<u>FR075P</u> <u>FR075P/GL</u>	 	

9 <ul style="list-style-type: none"> Piattello base molla rotondo Round spring seat Plat de ressort rond Rund Plattfeder Plato de muella redondo Assento de mola redondo 	10 <ul style="list-style-type: none"> Piattello base molla ovale Oval spring seat Plat de ressort oval Oval Plattfeder Plato de muella oval Assento de mola oval
---	---

FIESTA VI

		10.08 -	 		FR081AS/GL FR081AD/GL	 			FR081P/GL	 	
--	--	---------	------	--	--------------------------	------	--	--	-----------	------	--

FIESTA COURIER

	(F3L, F5L)	07.91 - 12.93	 	FR035A	FR035A/GL	 	120		FR036P	FR036P/GL	 	50
	(F3L, F5L)	01.94 - 12.95	 	FR048A	FR048A/GL	 	120		FR036P	FR036P/GL	 	50
excl. 1.8 D	(J5, J3)	01.96 -		FR051A	FR051A/GL	 	120		FR036P	FR036P/GL	 	50
1.8 D	(J5, J3)	01.96 -		<u>FR052A</u>	FR052A/GL	 	120		FR036P	FR036P/GL	 	50

FOCUS

, ,	(DAW, DBW, DFW)	06.98 - 12.04	 	<u>FR068AS</u> <u>FR068AD</u>	FR068AS/GL FR068AD/GL	 	120 120		<u>FR068P</u> <u>FR068P/GL</u>	 	50
	(DNW)	06.98 - 12.04	 	<u>FR068AS</u> <u>FR068AD</u>	FR068AS/GL FR068AD/GL	 	120 120		<u>FR070P</u> <u>FR070P/GL</u>	 	50

FOCUS II

, ,	(DA)	11.04 -	 		FR077AS/GL FR077AD/GL	 			FR077P/GL	 	
	(DAW)	11.04 -	 		FR077AS/GL FR077AD/GL	 			FR078P/GL	 	
		10.06 -	 		FR077AS/GL FR077AD/GL	 			FR086P/GL	 	

FOCUS III

,		04.11 -	 		FR087AS/GL FR087AD/GL	 			FR087P/GL	 	
		05.11 -	 		FR087AS/GL FR087AD/GL	 			FR088P/GL	 	

OIL
GAS

OIL
GAS

FORD (EUR)

FOCUS C-MAX

	10.03 -	 		FR077AS/GL FR077AD/GL	 			FR077P/GL		
--	---------	------	--	--------------------------	------	--	--	-----------	--	--

FUSION

	(JU)	08.02 - 12.03	 		FR076AS/GL FR076AD/GL	 			FR076P/GL	
		01.04 -	 		FR079AS/GL FR079AD/GL	 			FR076P/GL	

9	Piattello base molla rotondo Round spring seat Plat de ressort rond Rund Platfeder Plato de muella redondo Assento de mola redondo	10	Piattello base molla ovale Oval spring seat Plat de ressort oval Oval Platfeder Plato de muella oval Assento de mola oval
----------	---	-----------	--

GALAXY

4X2, 4X4 excl.	(WGR)	02.95 - 05.06		FR054A	FR054A/GL		70		FR054P	FR054P/GL		40
	(CA1)	05.06 -	 		FR073AS/GL FR073AD/GL	 				FR073P/GL		

GRANADA

, (GGTL, GGFL, GGCL, GGNL, GU, GNU)		01.72 - 04.85		FR006A			55		FR007P			
, excl. 2.9 24V, 4X4	(GAE, GGE)	03.85 - 10.94			FR025A/GL		85	excl.		FR025P/GL		50
, 2.9 24V excl. 4X4	(GAE, GGE)	04.91 - 10.94			FR060A/GL		85	excl.		FR025P/GL		50
	(GAE, GGE)	02.92 - 10.94		FR060A	FR060A/GL		85					

KA

	(RB)	09.96 - 10.98	ACC19	FR055A	FR055A/GL		120	7	FR055P	FR055P/GL		60
	(RB)	11.98 - 03.00	ACC19	FR055A	FR055A/GL		120	8	FR071P	FR071P/GL		60
	(RB)	04.00 - 04.03	ACC19	FR055A	FR055A/GL		120			FR072P/GL		60
1.3i, 1.6i Street ka, Sport ka		04.03 - 12.07	 		FR082AS/GL FR082AD/GL	 				FR072P/GL		
		02.09 -	 		FI344A/GL					FI344P/GL		

7	Vedi disegno/note Ford Fiesta a pagina 50	Siehe Ford Fiesta Zeichnung/Anmerkung auf Seite 50
8	See drawing/note Ford Fiesta on page 50	Ver dibujo/anotación Ford Fiesta a la página 50
	Voir plan/note Ford Fiesta à la page 50	Ver figura/note Ford Fiesta na página 50

KUGA

		03.08 -	 		FR084AS/GL FR084AD/GL	 				FR084P/GL		
		03.13 -										



		OIL	GAS				OIL	GAS		
--	--	------------	------------	--	--	--	------------	------------	--	--

FORD (EUR)

MAVERICK

	(UDS, UNS)	02.93 - 06.96			NI010A/GL		30			NI011P/GL		40
2WD, 4WD	(IEZ)	12.00 -										

MONDEO I

,	(GBP)	03.93 - 05.93			<i>FR044A</i> /GL				<i>FR044P</i>	FR044P/GL		120	
excl. , 4X4													
,	(GBP)	06.93 - 08.96			<i>FR056A</i>	FR056A/GL		90		<i>FR044P</i>	FR044P/GL		120
excl. , 4X4													
, 4X4 excl.	(BNP)	01.95 - 08.96			<i>FR056A</i>	FR056A/GL		90	excl.				
Clipper	(BNP)	03.93 - 05.93				<i>FR044A</i> /GL			excl.		FR040P/GL		60
excl. , 4X4													
Clipper	(BNP)	06.93 - 08.96			<i>FR056A</i>	FR056A/GL		90	excl.		FR040P/GL		60
excl. , 4X4													
Clipper 4X4 excl.	(BNP)	01.95 - 08.96			<i>FR056A</i>	FR056A/GL		90	excl.		FR040P/GL		60

MONDEO II

,	(BAP, BFP)	09.96 - 10.00			FR057A/GL		100		<i>FR044P</i>	FR044P/GL		140	
excl. 2.5 ST200,													
Clipper excl.	(BNP)	09.96 - 10.00			FR057A/GL		100		excl.		FR040P/GL		60

MONDEO III

, excl. 3.0 24V, ST220	(B4Y, B5Y)	10.00 - 08.07			FR058A/GL		160				FR058P/GL		110
Clipper excl. 3.0 24V, ST220	(BWY)	10.00 - 08.07			FR058A/GL		160				FR059P/GL		50

MONDEO IV

		03.07 -			FR073AS/GL						FR073P/GL		
					FR073AD/GL								

ORION I/II

	(AFD)	07.83 - 11.84		ACC69	FR020A	FR020A/GL		90		FR017P	FR017P/GL		55
excl. 1.6i, 1.6 D													
	(AFD)	12.84 - 07.90		ACC69	FR020A	FR020A/GL		90		FR017P	FR017P/GL		55
excl. 1.6i, 1.6 D													
1.6i	(AFD)	01.83 - 11.84		ACC69		FR020A/GL		90			FR017P/GL		55
1.6i	(AFF)	12.84 - 07.90		ACC69		FR020A/GL		90			FR017P/GL		55
1.6 D	(AFF)	02.84 - 11.84		ACC69	FR023A	FR023A/GL		90		FR017P	FR017P/GL		55
1.6 D	(AFF)	12.84 - 07.90		ACC69	FR023A	FR023A/GL		90		FR017P	FR017P/GL		55

OIL
GAS

OIL
GAS

FORD (EUR)

ORION III

1.3 (GAL)	08.90 - 12.93	1	FR034A	FR034A/GL		90		FR033P	FR033P/GL		45
1.4	08.90 - 10.90	ACC69									
1.4 (GAL)	10.90 - 12.93	2	FR033A	FR033A/GL		90		FR033P	FR033P/GL		45
1.4i, 1.6, 1.6i, 1.8i excl.Ghia	08.90 - 12.93	ACC69									
1.4i, 1.6i, 1.8i Ghia (GAL)	08.90 - 12.93	2	FR033A	FR033A/GL		90		FR033P	FR033P/GL		45
1.8 D (GAL)	08.90 - 10.90	1	FR034A	FR034A/GL		90		FR033P	FR033P/GL		45
1.8 D, 1.8 TD (GAL)	11.90 - 12.93	2	FR033A	FR033A/GL		90		FR033P	FR033P/GL		45

- 1** **1** Vedi disegno/nota Ford Escort a pagina 49 **D** Siehe Ford Escort Zeichnung/Anmerkung auf Seite 49
2 **GB** See drawing/note Ford Escort on page 49 **E** Ver dibujo/anotación Ford Escort a la página 49
F Voir plan/note Ford Escort à la page 49 **P** Ver figura/note Ford Escort na página 49

PICK-UP

Cortina, Taunus (1000 Kg)	1982 - 07.83					60					
Cortina, Taunus (1000 Kg)	08.83 - 1988					60					45
2.0, 1.8 TD	10.87 - 12.92					100					45

PROBE

excl. 3.0 V6,	08.88 - 07.93	ACC16		MZ006A/GL			ACC19	MZ006P/GL		
2.0 16V, 2.5 24V	07.93 - 03.98			MZ007AS/GL		110		MZ007P/GL		50

PUMA

1.4, 1.6, 1.7 (EC)	03.97 - 10.98			FR065A/GL		120	7		FR051P/GL		50
1.4, 1.6, 1.7 (EC)	11.98 - 06.02			FR065A/GL		120	8		FR066P/GL		

- 7** **1** Vedi disegno/nota Ford Fiesta a pagina 50 **D** Siehe Ford Fiesta Zeichnung/Anmerkung auf Seite 50
8 **GB** See drawing/note Ford Fiesta on page 50 **E** Ver dibujo/anotación Ford Fiesta a la página 50
F Voir plan/note Ford Fiesta à la page 50 **P** Ver figura/note Ford Fiesta na página 50

S-MAX

	05.06 -			FR073AS/GL					FR073P/GL		
--	---------	--	--	------------	--	--	--	--	-----------	--	--

SCORPIO I

(GAE, GGE)	03.85 - 10.94			FR025A/GL		85	excl.		FR025P/GL		50
excl. 2.9 24V, 4X4											
2.9 24V excl. 4X4 (GAE, GGE)	04.91 - 10.94			FR060A/GL		85	excl.		FR025P/GL		50
	02.92 - 10.94			FR060A	FR060A/GL	85					

SCORPIO II

2.0, 2.0 16V, 2.3 16V (GFR, GGR)	10.94 - 08.98			FR061AS/GL			excl.		FR025P/GL		50
2.5 TD, 2.9, 2.9 24V	10.94 - 08.98			FR061AD/GL							

OIL
GAS

OIL
GAS

FORD (EUR)

SIERRA

excl. XR4i	(GBC)	08.82 - 04.84	ACC81	<i>FR018A</i>	<i>FR018A</i> GL		60		<i>FR018P</i>	<i>FR018P</i> GL		50
2.8 XR4i	(GBC)	08.82 - 04.84			<i>FR018A</i> GL		60			<i>FR018P</i> GL		50
1.6, 1.8, 2.0 excl. 4X4, RS Cosworth	(GBC, GBG)	05.84 - 02.93	ACC81		<i>FR024A</i> GL		60		<i>FR018P</i>	<i>FR018P</i> GL		50
1.8 TD, 2.3 D excl. 4X4												
2.8 V6, 2.9 V6, XR4i	(GBC, GBG)	05.84 - 02.93	ACC81		<i>FR024A</i> GL		60			<i>FR018P</i> GL		50
excl. 4X4, RS Cosworth												
4x4 excl. RS Cosworth	(GBC, GBG)	05.84 - 02.93			<i>FR030A</i> GL							
4x2 RS Cosworth	(GBC, GBG)	1986 - 1990			<i>FR028A</i> GL							
4x4 RS Cosworth	(GBC, GBG)	1990 - 1993			<i>FR030A</i> GL							
excl. 4X4	(BNC)	08.82 - 04.84	ACC81	<i>FR018A</i>	<i>FR018A</i> GL		60	5	<i>FR023P</i>	<i>FR023P</i> GL		75
excl. 4X4	(BNC, BNG)	05.84 - 02.93	ACC81		<i>FR024A</i> GL		60	5	<i>FR023P</i>	<i>FR023P</i> GL		75
4X4	(BNC, BNG)	05.84 - 02.93			<i>FR030A</i> GL			5		<i>FR023P</i> GL		75

- 5**
- I** Se il veicolo è munito di correttore d'assetto, sostituire la molla con il rif. Ford 83 BB 5560 RC.
 - GB** If the vehicle is equipped with a self levelling suspension, replace the spring by a Ford one Nr. 83 BB 5560 RC.
 - F** Si le véhicule est équipé d'un correcteur d'assiette, remplacez le ressort par un rover Réf. GSV 1034.
 - D** Wenn das Fahrzeug mit automatischem Niveau-Ausgleich-System versehen ist, Originalfeder durch Ford Feder Nr. 83 BB 5560 RC ersetzen.
 - E** Si el vehículo está equipado con suspensión autonivelada, sustituya el muelle por un muelle ford Nº 83 BB 5560 RC.
 - P** Se o veículo estiver equipado com uma suspensão autonivelável, substitua a mola por uma Ford, ref. 83 BB 5560 RC.

OIL
GAS

OIL
GAS

FORD (EUR)

TRANSIT

, FT 75, FT 100 (71E, 72E, 73E, 74E, 81E) , FT 80, FT 100, FT 120 (V) ●-● = 2.69 m	09.70 - 12.77 01.78 - 10.85		FR104A		○			FR104P		○	
, , FT 125, FT 130, FT 150, FT 175 (71E, 72E, 73E, 74E, 81E) , , FT 100L, FT 130, FT 160, FT 190 (V) ●-● = 3.02 m	09.70 - 12.77 01.78 - 10.85		FR104A		○			FR104P		○	
(71E, 72E, 73E, 74E, 81E, V)	09.70 - 12.85		FR104A		○			FR104P		○	
, , 80, 100, 115, 120 (T) ●-● = 2.82 m	11.85 - 08.91		FR105A		⚡	75		FR105P		○	50
, , 100L, 130, 160, 190 (T) ●-● = 3.02 m, 3.47 m	11.85 - 08.91		FR106A		⚡	40		FR105P		○	50
, , 80, 100, 115, 120, 150 S (E) ●-● = 2.84 m	09.91 - 08.94		FR107A	FR107A/GL	⚡	60		FR104A		○	50
, , 130, 150 S, 100 L, 150 L, 190 L (E) ●-● = 3.57 m	09.91 - 08.94		FR107A	FR107A/GL	⚡	60		FR108P		○	50
, , 190 (E) ●-● = 3.57 m	09.91 - 08.94		FR107A	FR107A/GL	⚡	60		FR104A		○	50
, , 80, 100, 115, 120 (E) ●-● = 2.84 m	09.94 - 12.99		FR107A	FR107A/GL	⚡	60		FR104A		○	50
, , 150 S (E) ●-● = 2.84 m	09.94 - 12.99		FR107A	FR107A/GL	⚡	60		FR108P		○	50
, , 100L, 130, 150 L, 190 L (E) ●-● = 3.57 m	09.94 - 12.99		FR107A	FR107A/GL	⚡	60		FR108P		○	50
, , 190, 190EF (E) ●-● = 3.57 m	09.94 - 12.99			FR107A/GL	⚡	60					
, Tourneo, excl. 350L (FA_Y, FB_Y, FC_Y, FD_Y, FM_Y, FN_Y, FS_Y, FZ_Y)	01.00 - 05.06		FR109A	FR109A/GL	⚡	110	①	FR109P	FR109P/GL	○	45
(FA_Y, FB_Y, FC_Y, FD_Y, FM_Y, FN_Y, FS_Y, FZ_Y)	01.00 - 05.06		FR109A	FR109A/GL	⚡	110	②	FR111P	FR111P/GL	○	45
●-● = 2.93 m excl. □ ●-● = 3.13 m excl. □ (FB_Y, FC_Y, FD_Y, FM_Y, FN_Y, FS_Y, FZ_Y)	01.00 - 05.06 01.00 - 05.06		FR109A	FR109A/GL	⚡	110	③	FR112P		○	45
●-● = 3.30 m, ●-● = 3.75 m ●-● = 3.50 m, ●-● = 3.95 m excl. ■-■, □ (FA_Y, FB_Y, FC_Y, FD_Y, FM_Y, FN_Y, FS_Y, FZ_Y)	01.00 - 05.06 01.00 - 05.06		FR109A	FR109A/GL	⚡	110	④	FR112P		○	45



ANTERIORE
FRONT

POSTERIORE
REAR



		OIL	GAS				OIL	GAS		
--	--	------------	------------	--	--	--	------------	------------	--	--

FORD (EUR)

TRANSIT

300M, 300S Incl. Tourneo	07.06 -			FR113A/GL			4		FR113P/GL		
330L, 330M, 350L, 350M Incl. Tourneo	07.06 -			FR115A/GL			5		FR114P/GL		
Incl. Tourneo	07.06 -			FR115A/GL			6		FR115P/GL		
330S 330S Incl. Tourneo	07.06 -			FR115A/GL			3		FR112P/GL		

TRANSIT CONNECT - TOURNEO CONNECT

	(P65, P70, P80)	06.02 -			FR083AS/GL					FR083P/GL		
					FR083AD/GL							

	1	2	3	4	5	6
	FR109P FR109P/GL A = 14 mm. B = 12 mm. La = 505 mm. Lc = 325 mm.	FR111P FR111P/GL A = 14 mm. B = 12 mm. La = 550 mm. Lc = 350 mm.	FR112P FR112P/GL A = 14 mm. B = 12 mm. La = 610 mm. Lc = 370 mm.	FR113P/GL A = 14 mm. B = 12 mm. La = 480 mm. Lc = 305 mm.	FR114P/GL A = 14 mm. B = 12 mm. La = 580 mm. Lc = 355 mm.	FR115P/GL A = 14 mm. B = 12 mm. La = 635 mm. Lc = 585 mm.

FORD

OIL
GAS

OIL
GAS

HONDA (J)

ACCORD I/II

	(SY, AC, AD)	10.81 - 05.85	ACC18	HD003A/GL		85	ACC18	HD003P/GL		145
--	--------------	---------------	-------	-----------	--	----	-------	-----------	--	-----

ACCORD III

	(CA4, CA5)	06.85 - 12.89		HD013A/GL		85		HD013P/GL		145
--	------------	---------------	--	-----------	--	----	--	-----------	--	-----

ACCORD IV

excl. 4WS	(CB1, CB3)	01.90 - 03.93		HD014A/GL		145		HD014P/GL		
4WS	(CB7)	01.90 - 03.93		HD014A/GL		145				
Aerodeck	(CB8)	01.91 - 12.93		HD014A/GL		145		HD019P/GL		145

ACCORD V

	(CC7)	03.93 - 02.96		HD014A/GL		145		HD014P/GL		145
2.0	(CC1)	03.93 - 01.96		HD014A/GL				HD035P/GL		
, 2.0, 2.2	(CD7, CD9, CE1, CE2)	09.93 - 09.98		HD014A/GL				HD015P/GL		

ACCORD VI

1.8, 2.0, 2.2	(CE7, CE8, CE9)	01.96 - 09.98		HD014A/GL				HD035P/GL		
2.0 D, 2.0 TD	(CF)	01.96 - 09.98								

ACCORD VII

1.6, 1.8, 2.0, 2.0 TD	(CG7, CG8, CG9, CH2)	10.98 - 01.03		HD030A/GL		80		HD030P/GL		140
2.0 16V, 2.3 Vti	(CG4, CG3)	02.98 - 01.03		HD033A/GL		160		HD033P/GL		120

ACCORD VIII

2.0i, 2.4i, 2.2 CDTi	(CL7, CL9, CN1)	02.03 -		HD036A/GL				HD036P/GL		
2.0, 2.4, 2.2 CDTi	(CM1, CM2, CN2)	02.03 -		HD036A/GL				HD043P/GL		

ACCORD IX

excl.	(CU)	07.08 -		HD047AS/GL				HD047P/GL		
				HD047AD/GL						

CIVIC I/II

	(SL)	10.79 - 12.81	ACC11	HD006A/GL		135		HD006P/GL		
	(SL)	01.82 - 09.83						HD006P/GL		
excl. CRX, Shuttle	(AG, AH, AJ, AK, AL, AM)	10.83 - 10.87	ACC18	HD005A/GL		85		HD005P/GL		75

CIVIC III/BALLADE

, 1.2, 1.3, 1.4	(EC7, ED1, EC8, EC9, ED2)	10.87 - 12.88		HD009A/GL		135		HD009P/GL		135
, 1.5, 1.6	(ED6, ED3, ED4, ED7)	10.87 - 12.88								
→ Ch. S100001										
, 1.2, 1.3, 1.4	(EC7, ED1, EC8, EC9, ED2)	01.89 - 11.91		HD010A/GL		135		HD010P/GL		135
, 1.5, 1.6	(ED6, ED3, ED4, ED7)	01.89 - 11.91								
Ch. S100002 →										
, 1.6 4X4	(EE5)	01.89 - 12.90		HD011A/GL				HD011P/GL		
Ch. S10... → S200000										
, 1.6 4X4	(EE5)	01.90 - 11.91		HD011A/GL				HD018P/GL		
Ch. S200001 →										

HONDA

OIL
GAS

OIL
GAS

HONDA (J)

CIVIC IV/BALLADE

1.3, 1.5 1.6 1.5, 1.6	(EG3, EG4, EG8) (EG5, EG6, EG9, EH9) (EJ1, EJ2)	10.91 - 11.95 10.91 - 11.95 01.94 - 03.96	 		HD025AS/GL HD025AD/GL	 	70			HD012P/GL		80
-----------------------------	---	---	------	--	--------------------------	------	----	--	--	-----------	--	----

CIVIC IV/V

1.4, 1.5 1.6, 1.8 1.4, 1.5, 1.6	(MA8, MB2, MA9, MB3) (MB1, MB4, MB6) (EJ9, EK3, EK1)	09.94 - 02.01 09.94 - 02.01 11.95 - 02.01	 		HD025AS/GL HD025AD/GL	 	70			HD021P/GL		80
---------------------------------------	--	---	------	--	--------------------------	------	----	--	--	-----------	--	----

CIVIC V

1.6 1.6 VTEC, VTi 2.0 iTD Aerodeck 1.4, 1.5, 1.6, 1.8, 2.0i TD	(EJ6) (EJ7, EJ8, EM1) (MB7) (MB8, MB9, MC1, MC2, MC3)	11.95 - 02.01 11.95 - 02.01 01.97 - 02.01 04.98 - 02.01	 		HD021A/GL HD025AS/GL HD025AD/GL	 				HD021P/GL RV012P/GL RV012P/GL	 	
--	--	--	------	--	---------------------------------------	----------	--	--	--	-------------------------------------	----------	--

CIVIC VI

(3 𐄂), (EM2, EP1, EP2, ES4, ES5) excl. 1.7 CTDi, 2.0 sport, R type		02.01 - 09.05	 		HD032AS/GL HD032AD/GL	 				HD032P/GL		
(5 𐄂) excl. 1.7 CTDi, 2.0 sport, R type	(EU5/7, EU6/8)	02.01 - 02.06	 		HD032AS/GL HD032AD/GL	 				HD034P/GL		
(3/5 𐄂) 1.7 CTDi (3 𐄂) 2.0 R type (5 𐄂) 2.0i	(EP4, EU9) (EP3) (EV1)	04.02 - 02.06 02.01 - 02.06 09.03 - 02.06	 		HD034AS/GL HD034AD/GL	 				HD034P/GL		

CIVIC VII

excl.	(FN, FK)	01.06 -	 		HD044AS/GL HD044AD/GL	 				HD044P/GL		
-------	----------	---------	------	--	--------------------------	------	--	--	--	-----------	--	--

CIVIC/BALLADE SHUTTLE II

1.4, 1.5, 1.6 4X4 → Ch. S100001	(EE1, EE2, EE4)	01.88 - 12.88	 			 				HD018P/GL		135
1.4, 1.5, 1.6 4X4 Ch. S100002 → S200000	(EE1, EE2, EE4)	01.89 - 12.89			HD011A/GL		135			HD011P/GL		135
1.4, 1.5, 1.6 4X4 Ch. S200001 →	(EE1, EE2, EE4)	01.90 - 02.95			HD011A/GL		135			HD018P/GL		135

CIVIC/BALLADE CRX I

CRX 1.5, 1.6 excl. 1.6 DOHC	(AF, AS)	10.83 - 10.87		ACC18	HD005A/GL					HD005P/GL		
--------------------------------	----------	---------------	--	-------	-----------	--	--	--	--	-----------	--	--

CIVIC/BALLADE CRX II

CRX 1.6i 16V → Ch. S100001	(ED9)	10.87 - 12.88			HD009A/GL		85			HD009P/GL		130
CRX 1.4 Ch. S200001 → CRX 1.6 DOHC Ch. S10... →	(EE6) (EE6, EE8, ED9)	01.90 - 02.92 01.89 - 02.92			HD010A/GL		85			HD010P/GL		
CRX 1.6 SOHC Ch. S100002 →	(ED9)	01.89 - 02.92			HD010A/GL		85			HD009P/GL		

OIL
GAS

OIL
GAS

HONDA (J)

CIVIC/BALLADE CRX III

CRX 1.6i ESI	(EH6)	03.92 - 12.98			HD025AS/GL		120			HD012P/GL		120
CRX 1.6i VTi	(EG2)	03.92 - 12.98			HD025AD/GL							

CONCERTO

	(HW)	08.89 - 03.95			RV005AS/GL		120			HD021P/GL		85
					RV005AD/GL							

CR-V

	(RD)	10.95 - 07.02			HD026A/GL		120			HD026P/GL		100
	(RD)	07.02 - 09.06			HD042AS/GL					HD042P/GL		
					HD042AD/GL							

HR-V

1.6 16V 4x2	(GH)	03.99 -			HD027AS/GL		60			HD027P/GL		50
1.6 16V 4x4	(GH)	03.99 -			HD027AD/GL							

INTEGRA/QUINT

	(AV, DA)	02.85 - 04.89			HD005A/GL		135			HD005P/GL		100
--	----------	---------------	--	--	-----------	--	-----	--	--	-----------	--	-----

JAZZ

	(GD)	03.02 - 04.05			HD031AS/GL					HD031P/GL		100
					HD031AD/GL							
	(GD)	04.05 - 07.08			HD045AS/GL					HD031P/GL		100
					HD045AD/GL							
	(GE)	07.08 -			HD046AS/GL					HD046P/GL		100
					HD046AD/GL							

LEGEND

2.5	(HS)	01.86 - 1988			HD037A/GL					RV003P/GL		
2.7	(KA4)	1989 - 12.90			HD037A/GL					HD037P/GL		
2.7	(KA3)	1989 - 12.90										
	(KA7)	01.91 - 02.96										
	(KA8)	01.91 - 02.96										

LOGO

1.3	(GA3)	03.99 - 03.02			HD028AS/GL					HD028P/GL		100
					HD028AD/GL							

PASSPORT/JAZZ

	(AA)	01.94 - 12.97			HD039A/GL		100			HD039P/GL		100
		01.98 -			HD039A/GL		100			HD040P/GL		100

PRELUDE II/III

	(AB, BA1, BA2)	11.83 - 09.87			HD004A/GL		85	ACC18		HD003P/GL		135
excl. 4 WS	(BA)	10.87 - 01.92			HD016A/GL		135			HD016P/GL		145

PRELUDE IV

	(BB1, BB2, BB3)	02.92 - 09.96			HD017A/GL		120			HD017P/GL		140
--	-----------------	---------------	--	--	-----------	--	-----	--	--	-----------	--	-----

HONDA



ANTERIORE
FRONT

POSTERIORE
REAR



		OIL	GAS				OIL	GAS		
--	--	------------	------------	--	--	--	------------	------------	--	--

HONDA (J)

PRELUDE V

	(BB5, BB6, BB8, BB9) excl 2.2 Vti-S (BB6)	10.96 - 10.00	 		<u>HD029AS/GL</u> <u>HD029AD/GL</u>	 	90			<u>HD017P/GL</u>		140
--	--	---------------	------	--	--	------	----	--	--	------------------	--	-----

QUINTET

	(SU, TU, TL, TS)	02.80 - 12.84			<u>HD006A/GL</u>					<u>HD006P/GL</u>		95
--	------------------	---------------	--	--	------------------	--	--	--	--	------------------	--	----

SHUTTLE/ODYSSEY

	(RA1, RA3)	01.95 - 12.97	 		<u>HD038AS/GL</u> <u>HD038AD/GL</u>	 				<u>HD038P/GL</u>		
--	------------	---------------	------	--	--	------	--	--	--	------------------	--	--

STREAM

	(RN1, RN3)	05.01 -	 		<u>HD041AS/GL</u> <u>HD041AD/GL</u>	 				<u>HD041P/GL</u>		
--	------------	---------	------	--	--	------	--	--	--	------------------	--	--

HYUNDAI (KO)

ACCENT/PONY/EXCEL

1.2, 1.4		01.77 - 12.84								<u>SK001P/GL</u>		
1.3, 1.6		10.85 - 08.89								<u>HY002P</u> <u>HY002P/GL</u>		
	(X2)	09.89 - 08.94			<u>HY002A/GL</u>					<u>HY002P</u> <u>HY002P/GL</u>		
	(X3)	09.94 - 04.97	 		<u>HY010AS/GL</u> <u>HY010AD/GL</u>	 	60	 		<u>HY010PS/GL</u> <u>HY010PD/GL</u>	 	100
	(X3)	05.97 - 01.00	 		<u>HY010AS/GL</u> <u>HY010AD/GL</u>	 	60	 		<u>HY020PS/GL</u> <u>HY020PD/GL</u>	 	100
	(LC)	01.00 - 10.05	 		<u>HY020AS/GL</u> <u>HY020AD/GL</u>	 		 		<u>HY020PS/GL</u> <u>HY020PD/GL</u>	 	
	(MC)	11.05 -	 		<u>HY030AS/GL</u> <u>HY030AD/GL</u>	 				<u>HY030P/GL</u>		

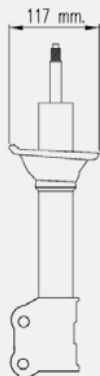

1
HY010PD/GL
HY010PS/GL

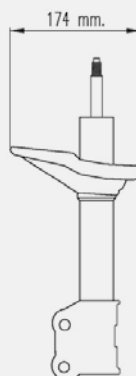

2
HY020PS/GL
HY020PD/GL

OIL
GAS

OIL
GAS

HYUNDAI (KO)

ATOS/SANTRO

	(MX)	11.97 - 10.98	 	<i>HY013AS</i> <i>HY013AD</i>	HY013AS/GL HY013AD/GL	 		<i>HY013P</i>	HY013P/GL		
	(MX)	11.98 -	 		HY016AS/GL HY016AD/GL	 	60	<i>HY013P</i>	HY013P/GL		

ATOS PRIME

	(MX)	11.98 -	 		HY016AS/GL HY016AD/GL	 	60	<i>HY013P</i>	HY013P/GL		
--	------	---------	----------	--	--------------------------	------	----	---------------	-----------	--	--

1

HY013AS
HY013AD
HY013AS/GL
HY013AD/GL

2

HY016AS/GL
HY016AD/GL

COUPÉ

	(RD)	06.96 - 04.02 06.96 - 04.02	 		HY012AS/GL HY012AD/GL	 	90	 	HY012PS/GL HY012PD/GL	 	100
	(GK)	03.02 -	 		HY018AS/GL HY018AD/GL	 	90	 	HY018PD/GL HY018PS/GL	 	100

GALLOPER

	(JK-01)	08.98 -			HY025A/GL		50		MT003P/GL		50
--	---------	---------	--	--	-----------	--	----	--	-----------	--	----

GETZ

	(TB)	08.02 -	 		HY019AS/GL HY019AD/GL	 			HY019P/GL		
--	------	---------	------	--	--------------------------	------	--	--	-----------	--	--

H1/SATELLITE/STAREX

	(KMJ)	06.97 -			HY026A/GL				HY026P/GL		
	(KMJ, KMF)	06.97 -			HY026A/GL				HY031P/GL		

H100

	FD Series	07.93 -			NI012A/GL		50		HY009P/GL		50
--	-----------	---------	--	--	-----------	--	----	--	-----------	--	----

i10

	(PA)	01.08 -	 		KI004AS/GL KI004AD/GL	 			HY034P/GL		
--	------	---------	------	--	--------------------------	------	--	--	-----------	--	--



		OIL	GAS				OIL	GAS		
--	--	------------	------------	--	--	--	------------	------------	--	--

HYUNDAI (KO)

i20

	(PB)	09.08 -			HY035AS/GL					HY035P/GL		
					HY035AD/GL							

i30

	O.E. 54651-2R100 / 54651-2R200	(FD)	10.07 -			HY037AS/GL				HY032P/GL		
	O.E. 54661-2R100 / 54661-2R200					HY037AD/GL						
	O.E. 54651-2L100 / 54651-2L200 / 54651-2L600	(FD)	10.07 -			HY036AS/GL				HY032P/GL		
	O.E. 54661-2L100 / 54661-2L200 / 54661-2L600					HY036AD/GL						

i40

	(VF)	07.11 -										

ix20

	(JC)	11.10 -								HY035P/GL		

ix35

	(LM, EL, ELH)	01.10 -										

LANTRA/ELANTRA

	(J1)	12.90 - 09.95			HY001A/GL		110			HY001P/GL		85
	(J2)	11.95 - 10.00			HY012AS/GL					HY012PS/GL		
		02.96 -			HY012AD/GL					HY012PD/GL		
	(XD)	06.00 -			HY012AS/GL					HY023PS/GL		
					HY012AD/GL					HY023PD/GL		

MATRIX

	(FC)	06.01 - 12.05			HY021AS/GL					HY021PS/GL		
					HY021AD/GL					HY021PD/GL		

S COUPÉ

	1.5, 1.5 Turbo	(SLC)	09.89 - 05.96		HY002A/GL		110		HY002P	HY002P/GL		40
--	----------------	-------	---------------	--	-----------	--	-----	--	--------	-----------	--	----

SANTA FÉ

	(SM)	02.01 - 03.06			HY015AS/GL					HY015P/GL		
					HY015AD/GL							
	(CM)	03.06 -			HY029AS/GL					HY029P/GL		
					HY029AD/GL							

SANTAMO

			10.98 -		MT002A/GL		110			MT002P/GL		70
--	--	--	---------	--	-----------	--	-----	--	--	-----------	--	----

OIL
GAS

OIL
GAS

HYUNDAI (KO)

SONATA/SONICA

	(Y2)	10.88 - 04.93			<i>HY003A/GL</i>					<i>HY003P/GL</i>		
	(Y3)	05.93 - 06.98			<i>HY008A/GL</i>					<i>HY008P/GL</i>		
	(EF)	06.98 - 04.00			<i>HY027A/GL</i>		60	1		<i>HY027P/GL</i>		60
	(EF)	04.00 - 04.01			<i>HY027A/GL</i>		60	2		<i>HY028P/GL</i>		
	(EF)	04.01 - 11.04			<i>HY028A/GL</i>			2		<i>HY028P/GL</i>		
2.4 GLS, 3.3 V6 GLS	(NF)	01.05 -			<i>HY033A/GL</i>					<i>HY033P/GL</i>		
2.0 CRDi GLS		02.06 -										

TERRACAN

	(HP)	05.01 -			<i>HY024A/GL</i>					<i>HY024P/GL</i>		
--	------	---------	--	--	------------------	--	--	--	--	------------------	--	--

TRAJET

	(FO)	03.00 -			<i>HY022AS/GL</i>					<i>HY022P/GL</i>		
					<i>HY022AD/GL</i>							

TUCSON

	(JM)	08.04 -			<i>KI015AS/GL</i>					<i>KI015PS/GL</i>		
					<i>KI015AD/GL</i>					<i>KI015PD/GL</i>		

XG

	(XG)	12.98 -			<i>HY027A/GL</i>			1		<i>HY027P/GL</i>		
								2		<i>HY028P/GL</i>		

	1	2
	<i>HY027P/GL</i>	<i>HY028P/GL</i>
	A= 295	A= 145

INNOCENTI (I)

ELBA

	(146)	04.86 - 12.96		<i>FI063A</i>		70		<i>IN009P</i>		70
--	-------	---------------	--	---------------	--	----	--	---------------	--	----

KORAL

		1980 -	ACC21	<i>IN008A</i>		70		<i>FI013P</i>		90
--	--	--------	-------	---------------	--	----	--	---------------	--	----

MILLE

		1994 - 1995		<i>IN013A</i>				<i>IN013P</i>		
--	--	-------------	--	---------------	--	--	--	---------------	--	--

MINI, 90, 120

Mini 1001, 1300		1974 - 1982		<i>IN003A</i>				<i>IN003P</i>		
90, 120, De Tomaso		1974 - 1982								

MINI 3 CILINDRI

		1990 -		<i>IN007A</i>				<i>IN007P</i>		
--	--	--------	--	---------------	--	--	--	---------------	--	--

OIL
GAS

OIL
GAS

ISUZU (J)

GEMINI

PF 50, PF 60	1974 - 1979		<i>OG0094</i>		$\frac{1}{0}$			<i>OG009P</i>		$\frac{1}{0}$	
--------------	-------------	--	---------------	--	---------------	--	--	---------------	--	---------------	--

PIAZZA

JR 130	1981 - 1982		<i>OG0094</i>		$\frac{1}{0}$			<i>OG009P/GL</i>		$\frac{1}{0}$	
--------	-------------	--	---------------	--	---------------	--	--	------------------	--	---------------	--

PICK-UP

KB 2, KBD 2 (4X2)	1980 - 07.86			NI012A/GL	$\frac{1}{0}$				MT001P/GL	$\frac{0}{0}$	
KB 2, KBD 2 (4X2)	08.86 -				$\frac{1}{0}$				MT001P/GL	$\frac{0}{0}$	
KB 4, KBD 4 (4X4)	1980 -			NI012A/GL	$\frac{1}{0}$				NI003P/GL	$\frac{0}{0}$	
TFR Series CAMPO/BRAVA (4X2)	1988 -				$\frac{1}{0}$					$\frac{0}{0}$	
TFS Series CAMPO/BRAVA (4X4)	1988 -			OG055A/GL	$\frac{1}{0}$				NI003P/GL	$\frac{0}{0}$	

TROOPER / BIG HORN

4X4	(UBS)	1983 - 10.86			NI012A/GL	$\frac{1}{0}$				NI003P/GL	$\frac{0}{0}$	
4X4 excl.	(UBS)	11.86 - 1991			OG055A/GL	$\frac{1}{0}$				<i>HID039P/GL</i>	$\frac{1}{0}$	
	(UB)	1992 - 1996			OG055A/GL	$\frac{1}{0}$				OG046P/GL	$\frac{0}{0}$	
2 \square		1996 -			OG056A/GL	$\frac{1}{0}$				OG046P/GL	$\frac{0}{0}$	
4 \square		1996 -			OG056A/GL	$\frac{1}{0}$				OG046P/GL	$\frac{0}{0}$	
4X4 excl.	(UBS)	02.98 -			OG061P/GL	$\frac{1}{0}$				OG060P/GL	$\frac{0}{0}$	

IVECO (I)

DAILY, TURBO DAILY

28F8/U8 30.8 → Ch. 304675 35.8, 35.9, 35.10 40.8, A 40.8, 40.10, A 40.10	01.78 - 08.89 01.78 - 08.89 01.78 - 08.89 01.78 - 08.89	1 O.E. 4829233 93803675 93803892	FI144A		$\frac{0}{0}$	45	2 O.E. 4829235	FI144P		$\frac{0}{0}$	45
30.8 Ch. 304676 →	01.78 - 08.89	3 O.E. 4829234	FI307A		$\frac{0}{0}$	45	2 O.E. 4829235	FI144P		$\frac{0}{0}$	45
30.8, 30.9 New Daily 35.8, 35.10, 35.12 New Daily 40.8, A 40.8 New Daily	09.89 - 04.99 09.89 - 04.99 09.89 - 04.99	3 O.E. 4829234	FI307A		$\frac{0}{0}$	45	5 4 O.E. 4835372 4850528	FI302P FI355A		$\frac{0}{0}$ $\frac{0}{0}$	45 45
35.8 CB 5, 40.8, A 40.8	08.89 - 04.99	4 O.E. 8587219 8574216	FI355A		$\frac{0}{0}$	45	2 O.E. 4829235	FI144P		$\frac{0}{0}$	45
35.10 V, 45.10, A 45.10	08.89 - 04.99	4 O.E. 8587219 8574216	FI355A		$\frac{0}{0}$	45	5 O.E. 8586273	FI302P		$\frac{0}{0}$	45

OIL
GAS

OIL
GAS

IVECO (I)

DAILY, TURBO DAILY

45.10, A 45.10, 49.10 New Turbo Daily	09.89 - 04.99 09.89 - 04.99	4 O.E. 8587219 8574216	FI355A			45	4 O.E. 4835375	FI355A			45
49.10, 49.12	09.89 - 04.99	4 O.E. 8587219 8574216	FI355A			45	5 O.E. 8586273 4843748 4843749	FI302P			45
40 NC 35	08.89 - 04.99	2	FI144P			45	1	FI144A			45

DAILY S2000

35S9, 35S11, 35S13, 35S15	05.99 -	6	FI354A				8	FI354P			
35C9, 35C11, 35C13, 35C15	05.99 -	6 7	FI354A FI355A				8	FI354P			
50C11, 50C13, 50C15	05.99 -	7	FI355A				8	FI354P			

MASSIF

	10.08 -		FI357A					FI357P/GL			
--	---------	--	--------	--	--	--	--	-----------	--	--	--

La (Aperto-Extended) / Lc (Chiuso-Collapsed)

1	2	3	4	5	6	7	8
FI144A	FI144P	FI307A	FI355A	FI302P	FI354A	FI355A	FI354P
A = 16 mm.	A = 12 mm.	A = 16 mm.	A = 16 mm.	A = 16 mm.	A = 16 mm.	A = 16 mm.	A = 16 mm.
B = 16 mm.	B = 12 mm.	B = 16 mm.	B = 16 mm.	B = 16 mm.	B = 16 mm.	B = 16 mm.	B = 16 mm.
La = 504 mm.	La = 576 mm.	La = 416 mm.	La = 442 mm.	La = 587 mm.	La = 407 mm.	La = 428 mm.	La = 568 mm.
Lc = 312 mm.	Lc = 352 mm.	Lc = 266 mm.	Lc = 280 mm.	Lc = 355 mm.	Lc = 325 mm.	Lc = 280 mm.	Lc = 348 mm.



		OIL	GAS				OIL	GAS		
--	--	------------	------------	--	--	--	------------	------------	--	--

JAGUAR (GB)

S TYPE

	01.99 -			JAO02A/GL				JAO02P/GL		
--	---------	--	--	-----------	--	--	--	-----------	--	--

X TYPE

	01.01 -			JAO03A/GL				JAO03P/GL		
--	---------	--	--	-----------	--	--	--	-----------	--	--

XJ SERIES

XJ-6	1968 - 1986			JAO04A/GL		60	1	JAO04P/GL		75
Daimler Sovereign	1969 - 1984									
XJ-12, Sovereign V12	1972 - 02.93									
Daimler Double Six	1972 - 02.93									
XJS, XJSC	1975 -									

1	<ul style="list-style-type: none"> I 4 Ammortizzatori posteriori GB 4 Rear shock absorbers F 4 Ammortisseurs postérieur D 4 Hintere Stoßdämpfer E 4 Amortiguadores trasero P 4 Amortecedores traseira
----------	---

JEEP (USA)

CHEROKEE

		01.76 - 12.83					40					
excl. Grand Cherokee	(XJ)	01.84 - 11.01			JP001A/GL		40			JP001P/GL		40
incl. Liberty	(KJ)	09.01 - 12.07			JP004A/GL					JP004P/GL		
	(KK)	01.08 -			JP004A/GL					JP004P/GL		
Grand Cherokee excl. Up-Country sus.	(ZJ)	09.91 - 12.94			JP001A/GL		40			JP002P/GL		40
Grand Cherokee excl. Up-Country sus.	(ZJ)	01.95 - 04.99			JP001A/GL		40			JP002P/GL		40
Grand Cherokee excl. Up-Country sus.	(WJ, WG)	04.99 - 12.04			JP005A/GL					JP005P/GL		
Grand Cherokee	(WH, WK)	01.05 - 12.10			JP006A/GL					JP006P/GL		

COMANCHE

4X2	(MJ)	- 1986			JP001A/GL							
4X4	(MJ)	- 1986			JP001A/GL					NIO10P/GL		
		1987 - 1992										

COMPASS

	(MK49)	08.06 -			JP008AS/GL					JP008P/GL		
					JP008AD/GL							

OIL
GAS

OIL
GAS

JEEP (USA)

PATRIOT

	(MK74)	01.08 -	 		JP008AS/GL JP008AD/GL	 				JP008P/GL		
--	--------	---------	------	--	--------------------------	------	--	--	--	-----------	--	--

WAGONEER

		1976 - 1983										
(XJ) excl. Grand Wagoneer	(XJ)	1984 - 1995			JP001A/GL					JP001P/GL		
Grand Wagoneer (SJ)	(SJ)	1984 - 1990										

WRANGLER/LAREDO

Wrangler, Laredo (YJ)	(YJ)	1987 - 1995			JP007A/GL					JP007P/GL		
Wrangler, Laredo (TJ)	(YJ)	1996 - 1997			JP001A/GL							

KIA (KO)

BESTA

		02.96 -			<u>KI013A/GL</u>					<u>KI013P/GL</u>		
--	--	---------	--	--	------------------	--	--	--	--	------------------	--	--

CARENS

	(FC)	11.00 - 10.02	 		KI002AS/GL KI002AD/GL	 		 		KI002PS/GL KI002PD/GL	 	
	(UN)	09.06 -	 		KI017AS/GL KI017AD/GL	 				KI017P/GL		

CARNIVAL/SEDONA

	(UP, GQ)	08.99 - 05.06	 		<u>KI007AS/GL</u> <u>KI007AD/GL</u>	 				KI007P/GL		
	(VQ)	06.06 -	 		KI016AS/GL KI016AD/GL	 				KI016P/GL		

CEE'D

	(ED)	12.06 -	 		KI020AS/GL KI020AD/GL	 				HY032P/GL		
--	------	---------	------	--	--------------------------	------	--	--	--	-----------	--	--

CERATO

	(LD)	03.04 -	 		KI021AS/GL KI021AD/GL	 		 		KI021PS/GL KI021PD/GL	 	
--	------	---------	------	--	--------------------------	------	--	------	--	--------------------------	------	--

CLARUS/CREDOS

	(K9A)	07.96 -			<u>KI003AS/GL</u>		130			<u>KI003PS/GL</u>		130
	(GC)	05.98 -			<u>KI003AD/GL</u>					<u>KI003PD/GL</u>		

JOICE

	(M300E)	02.00 -			MT002A/GL					MT002P/GL		
--	---------	---------	--	--	-----------	--	--	--	--	-----------	--	--

OIL
GAS

OIL
GAS

KIA (KO)

MAGENTIS

	(GD)	02.01 - 12.05			<i>HY027A/GL</i>					<i>HY028P/GL</i>		
	(MG)	11.05 -			<i>KI017AS/GL</i>					<i>KI017P/GL</i>		
					<i>KI017AD/GL</i>							

PICANTO

	(BA)	04.04 -			<i>KI004AS/GL</i>					<i>KI004P/GL</i>		
					<i>KI004AD/GL</i>							

PICANTO II

	(TA)	05.11 -										
--	------	---------	--	--	--	--	--	--	--	--	--	--

PREGIO

	(TB)	10.97 -			<i>KI005A/GL</i>					<i>KI005P/GL</i>		
--	------	---------	--	--	------------------	--	--	--	--	------------------	--	--

PRIDE

	(DA)	10.96 -		<i>MZ022AS</i>	<i>MZ022AS/GL</i>		150		<i>MZ022P</i>	<i>MZ022P/GL</i>		75
				<i>MZ022AD</i>	<i>MZ022AD/GL</i>							

PRO CEE'D

	(ED)	02.08 -			<i>KI020AS/GL</i>					<i>HY032P/GL</i>		
					<i>KI020AD/GL</i>							

RIO

	(DC)	08.00 - 07.02			<i>KI009AS/GL</i>					<i>KI009P/GL</i>		
					<i>KI009AD/GL</i>							
	(DC)	07.02 - 05.05			<i>KI018AS/GL</i>					<i>KI018P/GL</i>		
					<i>KI018AD/GL</i>							
	(JB)	03.05 -			<i>KI019AS/GL</i>					<i>KI019P/GL</i>		
					<i>KI019AD/GL</i>							
	(UB)	09.11 -										

SEPHIA

ABS	(FA)	09.93 - 12.97		<i>KI010AS</i>			100		<i>KI010PS</i>			130
				<i>KI010AD</i>					<i>KI010PD</i>			

SHUMA

	(FB)	10.97 - 12.98			<i>KI001AS/GL</i>					<i>KI001PS/GL</i>		
					<i>KI001AD/GL</i>					<i>KI001PD/GL</i>		
	(FB)	01.99 - 04.01			<i>KI002AS/GL</i>					<i>KI001PS/GL</i>		
					<i>KI002AD/GL</i>					<i>KI001PD/GL</i>		
	(FB)	05.01 -			<i>KI014AS/GL</i>					<i>KI014PS/GL</i>		
					<i>KI014AD/GL</i>					<i>KI014PD/GL</i>		

OIL
GAS

OIL
GAS

KIA (KO)

SORENTO

	(JC)	08.02 -	 		KI006AS/GL KI006AD/GL	 				KI006P/GL		
3.3 V6, 2.5 CRDi 125 Kw	(JC)	12.06 -	 		KI006AS/GL KI006AD/GL	 				KI002P/GL		

SORENTO II

	(XM)	11.09 -	 			 						
--	------	---------	------	--	--	------	--	--	--	--	--	--

SPORTAGE

	(K00)	09.94 - 12.98			KI012A/GL		100			KI012P/GL		50
	(K00)	01.99 - 08.04	 		KI011AS/GL KI011AD/GL	 	100			KI011P/GL		50
	(JE)	10.04 -	 		KI015AS/GL KI015AD/GL	 		 		KI015PS/GL KI015PD/GL	 	

LADA (RUS)

110/111/112

	(2110, 2111, 2112)	01.95 - 03.04		LA005A	LA005A/GL				LA005P	LA005P/GL		
	(2110, 2111, 2112)	03.04 -	 			 				LA005P/GL		

DIVA, FORMA, SAGONA

	(2109, 21099)	09.87 -		LAC03A	LA003A/GL		100		LA003P	LA004P/GL		50
--	---------------	---------	--	--------	-----------	--	-----	--	--------	-----------	--	----

KALINKA/NOVA

,	(2104, 2105, 2108, 2109)	05.81 -		LAC01A	LA001A/GL		55		LAC01P	LA001P/GL		50
---	--------------------------	---------	--	--------	-----------	--	----	--	--------	-----------	--	----

NIVA

	(2121)	12.76 -		LA002A	LAC002A/GL		55		LA002P	LAC002P/GL		45
--	--------	---------	--	--------	------------	--	----	--	--------	------------	--	----

NIVA II

	(2123)	09.02 -										
--	--------	---------	--	--	--	--	--	--	--	--	--	--

SAMARA/NATACHA

	(2108, 2109)	01.86 -		LAC03A	LA003A/GL		100		LA003P	LA004P/GL		50
	(2108, 2109)	01.03 -	 			 				LA004P/GL		

VAZ

, 1.2, 1.3, 1.5, 1.6 (2101, 2102, 2103, 2104, 2105, 2106, 2107, 21011, 21061)		01.70 -		LAC01A	LA001A/GL		55		LAC01P	LA001P/GL		50
---	--	---------	--	--------	-----------	--	----	--	--------	-----------	--	----



OIL

GAS



OIL

GAS



LANCIA (I)

A 112 → (AUTOBIANCHI)

	03.78 - 12.86		AB005A		75		FI012P		70
--	---------------	--	--------	--	----	--	--------	--	----

DEDRA

1.6, 1.8, 1.9 TDS, 2.0, 2.0 16V excl. 4X4	(835)	01.89 - 12.97	ACC49	<i>FI068A</i>	FI068A/GL		80	<i>FI068P</i>	FI068P/GL		50
1.6, 1.8, 1.9 TDS, 2.0, 2.0 16V excl. 4X4	(835)	01.98 - 07.99			FI091A/GL		80	<i>FI068P</i>	FI068P/GL		50
4X4	(835)	09.94 - 12.97	ACC49		FI068A/GL		80				
4X4	(835)	01.98 - 07.99			FI091A/GL		80				

DELTA I

1.3, 1.5	(831AB0)	09.79 - 02.83	ACC39	<i>LN012A</i>	LN012A/GL		110		<i>LN018PS</i>	LN018PS/GL		175
1.3, 1.5 1.6 GT, 1.6 HF Turbo	(831AB0)	02.83 - 01.86 02.83 - 01.86	ACC39	<i>LN012A</i>	LN012A/GL		110		<i>LN018PS</i>	LN018PS/GL		175
1.3, 1.5, 1.9 D, 1.9 TD excl. 4X4 1.6, 1.6 GTie, 1.6 HF Turbo excl. 4X4	(831AB0)	02.86 - 01.94 02.86 - 01.94	ACC39	<i>LN023A</i>	LN023A/GL		110		<i>LN023PS</i>	LN023PS/GL		175
2.0 HF 8V Integrale 4X4 2.0 HF 16V Integrale 4X4	(831AB0)	02.86 - 01.94 1987 - 01.94			LN030A/GL		110			LN030P/GL		175
2.0 HF Integrale Evoluzione	(831AB0)	1987 -			LN031A/GL		110			LN031P/GL		175

DELTA II

1.4, 1.6	(836)	06.93 - 08.99	ACC49		LN038A/GL		80			FI071P/GL		50
1.8, 2.0 16V	(836)	06.93 - 08.99	ACC49		FI068A/GL		80	<i>FI068P</i>	FI068P/GL		50	
1.9 TD	(836)	10.94 - 08.99	ACC49		LN038A/GL		80	<i>FI068P</i>	FI068P/GL		50	
2.0 Turbo 16V excl.	(836)	06.93 - 08.99	ACC49		<i>LN037A</i> /GL		80			FI068P/GL		50

DELTA III

excl. 1.9 D Multijet	(844)	09.08 -	1		FI347A/GL					FI347P/GL		
1.9 D Multijet	(844)	09.08 -	2		FI351A/GL					FI347P/GL		

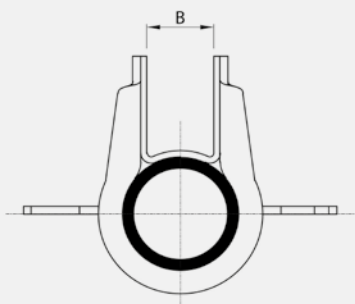
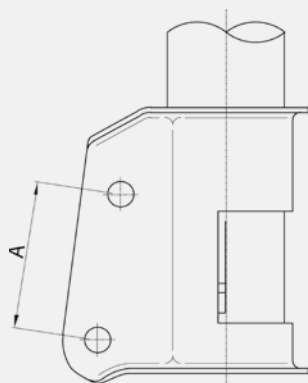

1

FI347A/GL
A = 58 mm
B = 25 mm

2

FI351A/GL
A = 72 mm
B = 35 mm

OIL
GAS

OIL
GAS

LANCIA (I)

KAPPA

2.0, 3.0 V6, 2.4 TDS, 2.4 JTD → Ch. 2050295	(838A)	10.94 - 10.01			LN034A/GL		120			LN034P/GL		240
2.0, 3.0, 2.4 TD, 2.4 JTD Ch. 2050296 → 2087505	(838A)	10.94 - 10.01			LN035A/GL		120			LN034P/GL		240
2.0, 3.0 V6, 2.4 TDS, 2.4 JTD Ch. 2087506 →	(838A)	10.94 - 10.01			LN035A/GL		120			LN035P/GL		240
2.4, 2.0 Turbo → Ch. 2087505	(838A)	10.94 - 10.01			LN034A/GL		120			LN034P/GL		240
2.4, 2.0 Turbo Ch. 2087506 →	(838A)	10.94 - 10.01			LN034A/GL		120			LN035P/GL		240
excl.	(838B)	07.96 - 10.01			LN034A/GL		120	E				
2.0, 3.0 V6, 2.4 TDS, 2.4 JTD	(838)	07.96 - 10.01			LN035A/GL		120			LN036P/GL		240
2.4, 2.0 Turbo	(838)	07.96 - 10.01			LN034A/GL		120			LN036P/GL		240

- 3**
- Ⓛ Sostituire ammortizzatore nivomat con LN034P/GL + Molla rinforzata (vedi catalogo molle di carico)
 - ⓐ Replace nivomat shock absorber with LN034P/GL + Reinforced spring (see catalogue auxiliary springs)
 - ⓕ Remplacer nivomat amortisseurs avec LN034P/GL + Renforcée spring (voir catalogue ressorts compensateurs de charge)
 - ⓓ Ersetzen nivomat Stoßdämpfer mit LN034P/GL + verstärkfedersätze (Siehe nivellierungsfedersätze-katalog)
 - ⓔ Reemplazar amortiguadores nivomat con LN034P/GL + muella reforzada (ver catálogo muelles compensadores de carga)
 - Ⓟ Substitua amortecedor nivomat com LN034P/GL + mola reforçada (ver catálogo mola de carga)

LYBRA

1.6, 1.8 excl.	(839AX)	07.99 - 10.05	1		LN044A/GL		120			LN044P/GL		60
2.0, 1.9 JTD, 2.4 JTD	(839AX)	07.99 - 10.05	2		LN045A/GL		120			LN044P/GL		60
1.6, 1.8 excl.	(839BX)	07.99 - 10.05	1		LN044A/GL		120			LN044P/GL		60
2.0, 1.9 JTD, 2.4 JTD	(839BX)	07.99 - 10.05	2		LN045A/GL		120			LN044P/GL		60

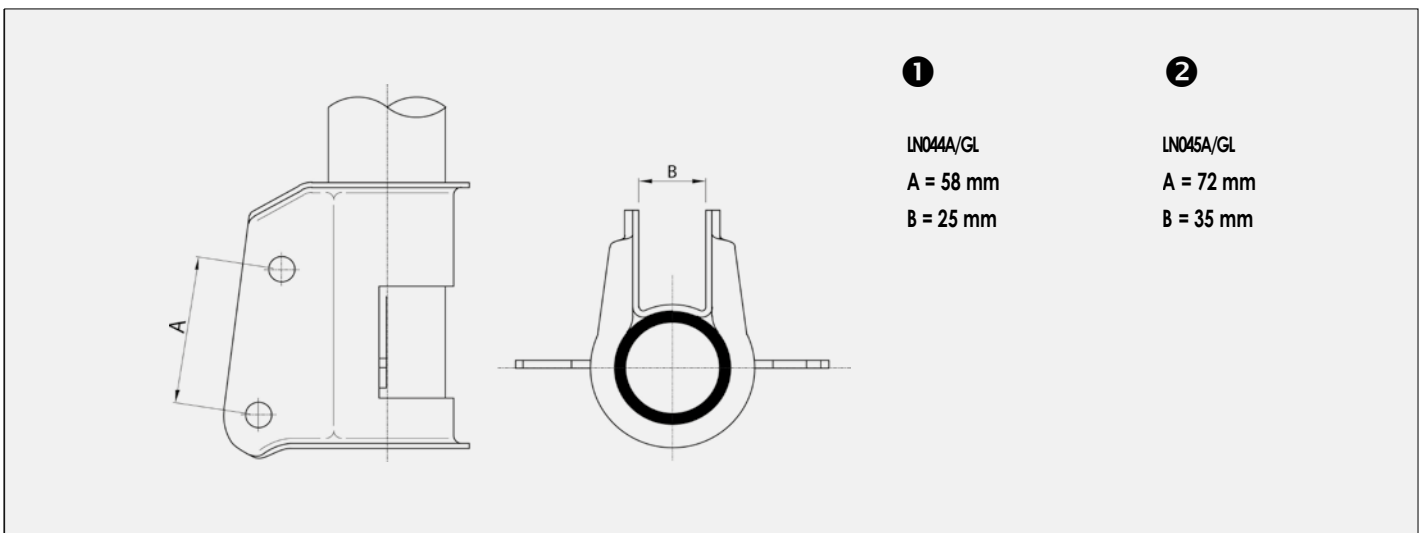

MUSA

1.4i	(350)	10.04 -			LN047A/GL					LN047P/GL		
1.3 JTD, 1.9 JTD	(350)	10.04 -			LN048A/GL					LN047P/GL		

PHEDRA

	(179)	09.02 - 11.10			LN049AS/GL		90			LN049P/GL		50
--	-------	---------------	--	--	------------	--	----	--	--	-----------	--	----



		OIL	GAS				OIL	GAS		
--	--	------------	------------	--	--	--	------------	------------	--	--

LANCIA (I)

PRISMA

1.3, 1.5, 1.6 1.9 D, 1.9 TD	(831AB0)	02.83 - 01.86 02.83 - 01.86		<i>LN012A</i>	LN012A/GL		110		<i>LN018PS</i>	LN018PS/GL		175
1.3, 1.5, 1.6 excl. 4X4 1.9 D, 1.9 TD excl. 4X4	(831AB0)	02.86 - 02.92 02.86 - 02.92		<i>LN023A</i>	LN023A/GL		110		<i>LN023PS</i>	LN023PS/GL		175
2.0 8V Integrale	(831AB0)	02.86 - 02.92			LN029A/GL		110			LN029P/GL		175

THEMA

→ Ch. 29408 excl. 3.0 V8 8.32,	(834)	11.84 - 10.86			LN019A/GL		90			<i>LN019P/GL</i>		130
Ch. 29409 → excl. 3.0 V8 8.32,	(834)	11.86 - 07.94			LN019A/GL		90			LN027P/GL		130
Ch. 29409 → excl. 3.0 V8 8.32,	(834)	11.86 - 07.94			LN019A/GL		90			LN027P/GL		130
3.0 V6 CRD, 3.6 V6 VVT		09.11 -			<u>LN051A/GL</u>					<u>LN051P/GL</u>		

Y 10 → (AUTOBIANCHI)

4X2	(156)	03.85 - 12.92		AB006AS AB006AD	AB006AS/GL AB006AD/GL		80		AB006P	AB006P/GL		40
4X2	(156)	01.93 - 12.95		AB006AS AB006AD	AB006AS/GL AB006AD/GL		80		AB007P	AB007P/GL		40
4X4	(156)	03.85 - 12.92		AB006AS AB006AD	AB006AS/GL AB006AD/GL		80		FIC037P	FIC037P/GL		40
4X4	(156)	01.93 - 12.95		AB006AS AB006AD	AB006AS/GL AB006AD/GL		80			FIC049P/GL		40

Y

excl. Elefantino Blu	(840A)	11.95 - 09.03			LN039A/GL		85			FIC078P/GL		50
Elefantino Blu	(840A)	11.95 - 09.03			FIC079A/GL		85			FIC078P/GL		50

YPSILON

	(843)	10.03 - 12.11			LN047A/GL		60			LN047P/GL		50
--	-------	---------------	--	--	-----------	--	----	--	--	-----------	--	----

YPSILON II

	(846)	05.11 -			LN050AS/GL LN050AD/GL		70			LN050P/GL		50
--	-------	---------	--	--	--------------------------	--	----	--	--	-----------	--	----

ZETA

(→ Ch. 7609)	(834)	03.94 - 12.97			FIC082A/GL		90		<i>FIC082P</i>	FIC082P/GL		
(Ch. 7610 →)	(834)	01.98 - 09.02			FIC082A/GL		90			LN042P/GL		

VOYAGER

MPV, Space Wagon		09.11 -			<u>LN051A/GL</u>					<u>LN051P/GL</u>		
------------------	--	---------	--	--	------------------	--	--	--	--	------------------	--	--

- | | | | |
|--|--|--|---|
| | | Vedi disegno/nota Fiat Scudo a pagina 44 | Siehe Fiat Scudo Zeichnung/Anmerkung auf Seite 44 |
| | | See drawing/note Fiat Scudo on page 44 | Ver dibujo/anotación Fiat Scudo a la página 44 |
| | | Voir plan/note Fiat Scudo à la page 44 | Ver figura/note Fiat Scudo na página 44 |

OIL
GAS

OIL
GAS

LAND ROVER

88/109 SERIES

●—● = 86"	01.53 - 06.56			<u>LR001A</u> /GL	♀	180				LR001P	/GL	♀	60
●—● = 88" I, II, IIA, IIB, III series	01.56 - 12.83												
●—● = 107"	01.53 - 11.58												
●—● = 109" I series	01.53 - 02.58												
●—● = 109" II, IIA, IIB, III series	01.58 - 12.84			<u>LR001A</u> /GL	♀	180				<u>LR002P</u>	/GL	♀	45
●—● = 119"	01.58 - 12.84												

90/110 SERIES

	09.83 - 07.90			<u>LR004A</u>	LR004A	/GL	†	95		<u>LR007P</u>	LR007P	/GL	♀	45
--	---------------	--	--	---------------	--------	-----	---	----	--	---------------	--------	-----	---	----

DEFENDER

	(LD)	09.90 -		<u>LR004A</u>	LR004A	/GL	†	95		<u>LR007P</u>	LR007P	/GL	♀	
--	------	---------	--	---------------	--------	-----	---	----	--	---------------	--------	-----	---	--

DISCOVERY I

→ Ch. MA135957	09.89 - 06.94			<u>LR003A</u>	LR004A	/GL	†	90		<u>LR003P</u>	LR003P	/GL	♀	45
----------------	---------------	--	--	---------------	--------	-----	---	----	--	---------------	--------	-----	---	----

DISCOVERY II

Ch. MA135958 →	(LJ, LT)	06.94 - 12.98			LR004A	/GL	†	70			LR004P	/GL	♀	45
----------------	----------	---------------	--	--	--------	-----	---	----	--	--	--------	-----	---	----

DISCOVERY III

excl. Active roll	(LJ, LT)	11.98 - 06.04			<u>LR009A</u> /GL		♀				<u>LR009P</u> /GL		♀	
excl. Active roll	(LJ, LT)	11.98 - 06.04			<u>LR009A</u> /GL		♀				<u>LR010P</u> /GL		♀	

FREELANDER

	(LN)	02.98 - 10.00	← →		LR008AS	/GL		70	← →		LR008PS	/GL		100
					LR008AD	/GL					LR008PD	/GL		
	(LN)	10.00 - 10.06	← →		LR011AS	/GL		70	← →		LR008PS	/GL		100
					LR011AD	/GL					LR008PD	/GL		

FREELANDER II

excl.	(FA)	10.06 -	← →						← →					
-------	------	---------	--------	--	--	--	--	--	--------	--	--	--	--	--

RANGE ROVER

●—● = 100" excl.	(LH)	06.70 - 07.94		<u>LR003A</u>	LR004A	/GL	†	105		<u>LR003P</u>	LR003P	/GL	♀	45
	(LH)	10.92 - 07.94			<u>LR006A</u> /GL		†	70			LR004P	/GL	♀	45
Classic excl.	(LH)	07.94 - 02.96		<u>LR003A</u>	LR004A	/GL	†	105		<u>LR003P</u>	LR003P	/GL	♀	45
Classic	(LH)	07.94 - 02.96			<u>LR006A</u> /GL		†	70			LR004P	/GL	♀	45
excl. Classic	(LP)	09.94 - 03.02			<u>LR005A</u> /GL		♀				<u>LR005P</u> /GL		♀	
	(LM)	03.02 - 08.12											♀	
Sport		02.05 -											♀	

SANTANA

●—● = 88" 2.5 DC, 2500 DC	01.58 - 12.89			<u>LR001A</u> /GL	♀						LR001P	/GL	♀	
●—● = 109", 119" 2.5DL/DE, 3.5DL, 2500DL, 3500DL	01.58 - 12.89			<u>LR001A</u> /GL	♀						<u>LR002P</u> /GL		♀	



		OIL	GAS				OIL	GAS		
--	--	------------	------------	--	--	--	------------	------------	--	--

MAZDA (J)

121/REVUE I

	(DA)	10.87 - 02.91	 	MZ022AS MZ022AD	MZ022AS/GL MZ022AD/GL		100		MZ022P	<u>MZ022P</u> /GL		75
--	------	---------------	------	--------------------	--------------------------	--	-----	--	--------	-------------------	--	----

121/REVUE II

	(DB)	03.91 - 03.96			MZ023A/GL		180			MZ023P/GL		160
--	------	---------------	--	--	-----------	--	-----	--	--	-----------	--	-----

121/REVUE III

	1.25, 1.3 16V, 1.4 16V	(JASM, JBSM)	08.95 - 09.98		FR051A	FR051A/GL		230	7	FR051P	FR051P/GL		100
	1.25, 1.3 16V	(JASM, JBSM)	10.98 -		FR051A	FR051A/GL		230	8	FR066P	FR066P/GL		100
	1.4 16V	(JASM, JBSM)	10.98 -		FR051A	FR051A/GL		230	7	FR051P	FR051P/GL		100
	1.8 D	(JASM, JBSM)	08.95 - 09.98		<u>FR052A</u>	FR052A/GL		230	7	FR051P	FR051P/GL		100
	1.8 D	(JASM, JBSM)	10.98 -		<u>FR052A</u>	FR052A/GL		230	8	FR066P	FR066P/GL		100

- 7 8**
- Ⓛ Vedi disegno/nota Ford Fiesta a pagina 50
 - Ⓒ See drawing/note Ford Fiesta on page 50
 - ⓕ Voir plan/note Ford Fiesta à la page 50
 - ⓓ Siehe Ford Fiesta Zeichnung/Anmerkung auf Seite 50
 - ⓔ Ver dibujo/anotación Ford Fiesta a la página 50
 - Ⓟ Ver figura/nota Ford Fiesta na página 50

2

	(DY)	01.03 - 12.03	 9	<u>FR075AS</u> <u>FR075AD</u>	FR075AS/GL FR075AD/GL				<u>FR075P</u>	FR075P/GL		100
	(DY)	01.04 -	 10	<u>FR080AS</u> <u>FR080AD</u>	FR080AS/GL FR080AD/GL				<u>FR075P</u>	FR075P/GL		100

- 9**
- Ⓛ Piattello base molla rotondo
 - Ⓒ Round spring seat
 - ⓕ Plat de ressort rond
 - ⓓ Rund Plattfeder
 - ⓔ Plato de muella redondo
 - Ⓟ Assento de mola redondo
- 10**
- Ⓛ Piattello base molla ovale
 - Ⓒ Oval spring seat
 - ⓕ Plat de ressort oval
 - ⓓ Oval Plattfeder
 - ⓔ Plato de muella oval
 - Ⓟ Assento de mola oval

2 II

	(DE)	10.07 -	 		MZ029AS/GL MZ029AD/GL					MZ029P/GL		100
--	------	---------	------	--	--------------------------	--	--	--	--	-----------	--	-----

3

	(BK)	10.03 - 06.09	 		MZ016AS/GL MZ016AD/GL					MZ016P/GL		100
--	------	---------------	------	--	--------------------------	--	--	--	--	-----------	--	-----

3 II

	(BL)	06.09 -	 		MZ016AS/GL MZ016AD/GL					MZ016P/GL		100
--	------	---------	------	--	--------------------------	--	--	--	--	-----------	--	-----

OIL
GAS

OIL
GAS

MAZDA (J)

323 II

1.1, 1.3, 1.5	(BD)	06.80 - 10.89	ACC19	<i>MZ001A</i>	<i>MZ001AGL</i>			ACC19	<i>MZ001P</i>	<i>MZ001PGL</i>		
---------------	------	---------------	-------	---------------	-----------------	--	--	-------	---------------	-----------------	--	--

323 III

1.1, 1.3, 1.4, 1.5, 1.6, 1.7 D excl. 4X4,	(BF)	01.85 - 05.89	ACC19	<i>MZ001A</i>	<i>MZ001AGL</i>		60	ACC19	<i>MZ001P</i>	<i>MZ001PGL</i>		110
excl. 4X4,	(BW12)	11.85 - 10.95	ACC19	<i>MZ001A</i>	<i>MZ001AGL</i>		60					110

323 IV

323 C, 323 S excl. 4X4,	(BF)	06.89 - 08.94			<i>MZ005ASGL</i>		100			<i>MZ005PSGL</i>		115
					<i>MZ005ADGL</i>					<i>MZ005PDGL</i>		
			ACC65					ACC66				
323 F 1.6, 1.8 excl. 4X4,	(BG)	06.89 - 08.94			<i>MZ005ASGL</i>					<i>MZ005PSGL</i>		115
					<i>MZ005ADGL</i>					<i>MZ005PDGL</i>		
			ACC65					ACC66				

323 V

1.3, 1.5, 1.7 TD, 1.8, 2.0 D	(BA)	09.94 - 09.98			<i>MZ011AS/GL</i>		60			<i>MZ011PS/GL</i>		90
323 F 1.3, 1.5, 1.8	(BA)	09.94 - 09.98			<i>MZ011AD/GL</i>					<i>MZ011PD/GL</i>		

323 VI

1.3, 1.5, 1.8, 2.0 D, 2.0 TD → Ch. 304194	(BJ)	09.98 - 12.99			<i>MZ014ASGL</i>		70			<i>MZ014PSGL</i>		100
					<i>MZ014ADGL</i>					<i>MZ014PDGL</i>		
1.3, 1.5, 1.8, 2.0 D, 2.0 TD Ch. 304195 → 400000	(BJ)	01.00 - 11.00			<i>MZ024ASGL</i>		70			<i>MZ024PSGL</i>		100
					<i>MZ024ADGL</i>					<i>MZ024PDGL</i>		
1.3, 1.5, 1.8, 2.0 D, 2.0 TD Ch. 400001 →	(BJ)	12.00 -			<i>MZ024ASGL</i>		70			<i>MZ024PSGL</i>		100
					<i>MZ024ADGL</i>					<i>MZ024PDGL</i>		

5

	(CR)	03.05 -			<i>MZ025AS/GL</i>					<i>MZ025P/GL</i>		
					<i>MZ025AD/GL</i>							

5 II

	(CW)	09.10 -			<i>MZ025AS/GL</i>					<i>MZ025P/GL</i>		
					<i>MZ025AD/GL</i>							

6

excl.	(GG)	06.02 -			<i>MZ017AS/GL</i>					<i>MZ017P/GL</i>		
excl. , 4X4	(GY)	08.02 -			<i>MZ017AD/GL</i>							
4X4 excl.	(GY)	06.02 -			<i>MZ018ASGL</i>							
					<i>MZ018ADGL</i>							
4x2	(GH)	08.07 -			<i>MZ026AS/GL</i>					<i>MZ026P/GL</i>		
					<i>MZ026AD/GL</i>							
4x4	(GH)	08.07 -			<i>MZ027AS/GL</i>					<i>MZ027P/GL</i>		
					<i>MZ027AD/GL</i>							



ANTERIORE
FRONT

POSTERIORE
REAR



		OIL	GAS				OIL	GAS		
--	--	------------	------------	--	--	--	------------	------------	--	--

MAZDA (J)

626 II

excl.	(GC)	11.82 - 05.87			MZ004A/GL		90			MZ004P/GL		150
-------	------	---------------	--	--	-----------	--	----	--	--	-----------	--	-----

626 III

, excl. 4WS,	(GD)	05.87 - 12.91			MZ006A/GL		90			MZ006P/GL		150
excl. 4X4, , 4WS	(GV)	03.88 - 09.97			MZ006A/GL		90					

626 IV

, excl. 4X4, 4WS	(GE)	08.91 - 04.97			MZ007AS/GL		260			MZ007P/GL		200
-------------------	------	---------------	--	--	------------	--	-----	--	--	-----------	--	-----

626 V

, excl. 4X4,	(GF)	04.97 - 07.99			MZ019AS/GL		70			MZ019PS/GL		120
					MZ019AD/GL					MZ019PD/GL		
excl. 4X4,	(GW)	04.97 - 07.99			MZ019AS/GL		70			MZ020PS/GL		120
					MZ019AD/GL					MZ020PD/GL		
, excl.	(GF)	08.99 - 10.02			MZ021AS/GL		70			MZ021PS/GL		120
					MZ021AD/GL					MZ021PD/GL		
excl. 4X4,	(GW)	08.99 - 10.02			MZ021AS/GL		70					
					MZ021AD/GL							

929 III

excl. 3.0 V6,	(HC)	09.86 - 05.89			MZ008A/GL		105			MZ008P/GL		40
excl.	(HC)	06.89 - 06.91			MZ009A/GL		105			MZ008P/GL		40

B SERIES

1.6, 1.8, 2.0	(BNA)	01.70 - 08.85		OG0024								
1600, 2000, 2200	(UF)	01.85 - 06.99			OG055A/GL		50		FI019P			
excl. 4X4		01.85 - 06.99										

DEMIO

	(DW)	08.98 - 12.99			MZ015AS/GL					MZ015P/GL		
					MZ015AD/GL							
	(DW)	01.00 - 12.02			MZ015AS/GL					MZ015P/GL		
					MZ015AD/GL							

E SERIES

E 1600		01.78 - 06.84		OG0024						DA002A/GL		
E 2200		01.78 - 06.84		OG0024					FI019P			40
E 1400, 1800	(SR1, SR2)	01.84 - 12.97					50			NI010P/GL		
E 2000, 2200		01.84 - 12.97										
excl. 4X4												
, E 1400, 1800	(SR1, SR2)	01.84 - 12.97					50		FI019P			40
, E 2000, 2200		01.84 - 12.97										
excl. 4X4												

OIL
GAS

OIL
GAS

MAZDA (J)

MPV

excl. 4X4	(LV52, LV12)	1993 - 09.99				MZD10A/GL					MZD10P/GL		
4X4	(LV52, LV12)	1993 - 09.99				MZD10A/GL					MZD10P/GL		
excl. 4X4	(LW)	09.99 - 03.02											
excl. 4X4	(LW)	03.02 -											

MX-3

	(EC)	07.91 -											

MX-5/MIATA

excl. ABS	(NA)	09.89 - 04.98				MZD13A/GL		160			MZD13P/GL		180
ABS	(NA)	09.89 - 04.98									MZD13P/GL		180
excl. ABS	(NB)	05.98 - 02.05											

MX-6

excl. 4WS,	(GE1)	07.91 - 1997				MZD07AS/GL					MZD07P/GL		
						MZD07AD/GL							
2.5 4WS excl.	(GE7)	07.91 - 1997				MZD07AS/GL							
						MZD07AD/GL							

PREMACY

	(CP)	07.99 - 06.01				MZD28AS/GL					MZD28PS/GL		
						MZD28AD/GL					MZD28PD/GL		
	(CP)	07.01 -				MZD14AS/GL					MZD28PS/GL		
						MZD14AD/GL					MZD28PD/GL		

OIL
GAS

OIL
GAS

MERCEDES (D)

190 SERIES (W201)

excl. 2.3-16, 2.5-16, sportline (W201)	11.82 - 08.93			MR007A/GL		105	excl.		MR007P/GL	$\frac{1}{\circ}$	65
2.3-16, 2.5-16, sportline (W201)	11.82 - 1993			MR008A/GL		105	excl.		MR007P/GL	$\frac{1}{\circ}$	65

200 SERIES (W114/115/116/123/124/126)

280 S, 280 SE, 280 SEL (W116)	09.72 - 07.80			MR004A/GL	$\frac{1}{\circ}$	50	excl.		MR003P/GL	$\frac{1}{\circ}$	65
200, 220, 230, 250 (W115)	01.68 - 01.77			MR003A/GL	$\frac{1}{\dagger}$	50			MR003P/GL	$\frac{1}{\dagger}$	65
200 D, 220 D (W115)	01.68 - 01.77										
280, 280 E, 240 D (W114)	06.72 - 11.76										
220, 240 D (W115)	01.68 - 12.79			MR003A/GL	$\frac{1}{\dagger}$	50					
200, 200 D, 220, 220 D (W123)	01.76 - 11.84			MR004A/GL	$\frac{1}{\circ}$	50			MR003P/GL	$\frac{1}{\circ}$	65
230, 240 D, 250 (W123)	01.76 - 11.84										
280, 280 E (W123)	01.76 - 11.84										
280 S, 280 SE, 280 SEL (W126)	10.79 - 12.85										
200, 200 E, 230 E, 260 E (W124)	11.84 - 06.93			MR007A/GL		105			MR007P/GL	$\frac{1}{\circ}$	65
200 D, 250 D, 250 Turbo-D (W124)	11.84 - 06.93										
excl. 4-matic, sportline											
sportline (W124)	11.84 - 06.93			MR008A/GL		105			MR007P/GL	$\frac{1}{\circ}$	65
260 SE (W126)	09.85 - 06.91			MR004A/GL	$\frac{1}{\circ}$	50	excl.		MR003P/GL	$\frac{1}{\circ}$	65
220, 220 D (W115)	01.68 - 12.78			MR003A/GL	$\frac{1}{\dagger}$	70			MR003P/GL	$\frac{1}{\dagger}$	90
230/4, 240 D (W115)	01.73 - 12.78										
200 T, 230 T, 230 TE (S123)	09.77 - 12.85			MR004A/GL	$\frac{1}{\circ}$	50					
240 T, 250 T, 280 TE (S123)	09.77 - 12.85										
200 T, 200 TD, 230 TE (S124)	09.85 - 06.93			MR007A/GL		145					
250 TD, 280 TE (S124)	09.85 - 06.93										
excl. 4-Matic, sportline											
sportline (S124)	09.85 - 06.93			MR008A/GL		145					
250 C, 250 CE (W114)	01.73 - 01.77			MR003A/GL	$\frac{1}{\dagger}$	70			MR003P/GL	$\frac{1}{\dagger}$	75
280 C, 280 CE (W115)	01.73 - 01.77										
230 C, 230 CE (C123)	03.77 - 12.85			MR004A/GL	$\frac{1}{\circ}$	50			MR003P/GL	$\frac{1}{\circ}$	75
280 C, 280 CE (C123)	03.77 - 12.85										
200 CE, 220 CE, 230 CE, 280 CE (C124)	03.87 - 06.93			MR007A/GL		145	excl.		MR007P/GL	$\frac{1}{\circ}$	75
excl. sportline											
(W111, W114, W115, W116)	01.60 - 12.80				$\frac{1}{\circ}$						
(W123, S123)	01.76 - 12.85										
(W126)	10.79 - 06.91										

300 SERIES (W116/123/124/126)

350 SE, 350 SEL (W116)	09.72 - 07.80			MR004A/GL	$\frac{1}{\circ}$	50	excl.		MR003P/GL	$\frac{1}{\circ}$	65
300 D (W123)	02.76 - 11.85										
300 SD Turbo D (W126)	01.81 - 06.91			MR004A/GL	$\frac{1}{\circ}$	50	excl.		MR003P/GL	$\frac{1}{\circ}$	65
380 SE, 380 SEL (W126)	12.79 - 12.86										
300 E, 320 E, 300 D, 300 D Turbo (W124)	11.84 - 06.93			MR007A/GL		105	excl.		MR007P/GL	$\frac{1}{\circ}$	65
excl. 4-matic, sportline											
300 SE, 300 SEL (W126)	09.85 - 06.91			MR004A/GL	$\frac{1}{\circ}$	50	excl.		MR003P/GL	$\frac{1}{\circ}$	65
300 TD (S123)	09.77 - 11.85			MR004A/GL	$\frac{1}{\circ}$	50					
300 TE, 300 TD Turbo, 320 TE (S124)	09.85 - 06.93			MR007A/GL		145					
excl. 4-Matic, sportline											

OIL
GAS

OIL
GAS

MERCEDES (D)

300 SERIES (W116/123/124/126)

sportline (S124)	09.85 - 06.93	ACC18		<u>MR008A/GL</u>		145				
300 CE, 320 CE (C124)	03.87 - 05.93	ACC18		MR007A/GL		145	excl.		MR007P/GL	$\frac{1}{0}$ 75
excl. sportline										
380 SEC (C126)	10.81 - 07.85			<u>MR004A/GL</u>	$\frac{1}{0}$	60	excl.		<u>MR003P/GL</u>	$\frac{1}{-}$ 80
300 D, 300 TD (W123, S123)	09.77 - 12.85				$\frac{0}{0}$					
, 380 SE, 380 SEL, 380 SEC (W126, C126)	10.81 - 06.91				$\frac{0}{0}$					

400 SERIES (W116/124/126)

450 SE, 450 SEL (W116)	03.73 - 07.80			<u>MR004A/GL</u>	$\frac{1}{0}$	50	excl.		<u>MR003P/GL</u>	$\frac{1}{-}$ 65
400 E (W124)	11.84 - 06.93	ACC18		MR007A/GL		105			MR007P/GL	$\frac{1}{0}$ 65
excl. 4-matic, sportline										
420 SE, 420 SEL (W126)	10.85 - 1991			<u>MR004A/GL</u>	$\frac{1}{0}$	60	excl.		<u>MR003P/GL</u>	$\frac{1}{-}$ 80
420 SEC (C126)	10.85 - 06.91									

500 SERIES (W126)

500 SE, 500 SEL, 560 SEL (W126)	12.79 - 06.91			<u>MR004A/GL</u>	$\frac{1}{0}$	50	excl.		<u>MR003P/GL</u>	$\frac{1}{-}$ 65
560 SEL (W126)	09.85 - 06.91									
500 SEC (C126)	10.81 - 08.85			<u>MR004A/GL</u>	$\frac{1}{0}$	60	excl.		<u>MR003P/GL</u>	$\frac{1}{-}$ 80
500 SEC, 560 SEC (C126)	09.85 - 06.91									
500 SE, 500 SEL, 500 SEC (W126)	1980 - 1991				$\frac{0}{0}$					

A CLASS (W168/169/176)

140, 160, 190, 160 CDI, 170 CDI (W168)	07.97 - 08.04			MR011A/GL		100			MR011P/GL	$\frac{0}{0}$ 80
150, 170, 200, 160 CDI, 180 CDI, 200 CDI (W169)	09.04 - 06.12			MR024A/GL					MR024P/GL	$\frac{1}{0}$
180, 200, 180 CDI, 200 CDI, 220 CDI excl. 4-matic (W176)	06.12 -			<u>MR033AS/GL</u> <u>MR033AD/GL</u>					<u>MR033P/GL</u>	$\frac{1}{0}$

B CLASS (W245/246)

150, 170, 200, 200 Turbo, 180 CDI, 200 CDI (W245)	03.05 - 11.11			MR024A/GL					MR024P/GL	$\frac{1}{0}$
180, 200, 180 CDI, 200 CDI, 220 CDI excl. 4-matic (W246)	11.11 -			<u>MR033AS/GL</u> <u>MR033AD/GL</u>					<u>MR033P/GL</u>	$\frac{1}{0}$

C CLASS (W202/203)

, C 180, C 200, C 220, C 230, C 240 (W202, S202)	05.93 - 03.01			MR009A/GL	$\frac{1}{0}$	90	excl.		MR009P/GL	$\frac{1}{0}$ 100
, C 200 D, C 220 D, C 250 D	05.93 - 03.01									
excl. Esprit, AMG,										
C 180, C 200, C 220, C 230, C 240 (W202, S202)	05.93 - 03.01			MR018A/GL	$\frac{1}{0}$	90	excl.		MR009P/GL	$\frac{1}{0}$ 100
C 200 D, C 220 D, C 250 D	05.93 - 03.01									
excl. Esprit, AMG,										
, C250 TD, C280 (W202)	05.93 - 03.01			MR018A/GL	$\frac{1}{0}$				MR018P/GL	$\frac{1}{0}$ 100
excl. Esprit, AMG,										
Esprit, sportline excl. AMG (W202, S202)	05.93 - 03.01			<u>MR019A/GL</u>	$\frac{1}{0}$	90			<u>MR019P/GL</u>	$\frac{1}{0}$ 100
(W203)	05.00 -			MR015A/GL		110			MR015P/GL	$\frac{1}{0}$ 80
T-Model (S203)	03.01 - 08.07			MR015A/GL		110			MR015P/GL	$\frac{1}{0}$ 80
Sportcoupé (CL203)	03.01 - 06.11			MR015A/GL		110			MR015P/GL	$\frac{1}{0}$ 80



KIT DI PROTEZIONE

Protection Kit

KIT DI PROTEZIONE

L'ammortizzatore è costantemente esposto ad agenti esterni deterioranti che possono comprometterne la corretta funzionalità ed aumentarne precocemente l'usura. Per ridurre questi rischi e per consentire un più efficace e sicuro funzionamento della sospensione è consigliato il montaggio dei Kit Di Protezione TOPLINE ad ogni cambio di ammortizzatori. Composti da tampone di fine corsa e soffietto parapolvere, i Kit TOPLINE assicurano una protezione efficace della sospensione e favoriscono una guida silenziosa, confortevole e sicura. L'elenco che segue riporta le applicazioni appropriate dei kit di Protezione sugli ammortizzatori TOPLINE. Nel catalogo potrete trovare inoltre il riferimento del kit per singolo veicolo in corrispondenza del codice dell'applicazione.

PROTECTION KIT

Shock absorbers are constantly exposed to deteriorating agents outdoors that can affect proper functionality and accelerate wear. In order to reduce risks of this kind and to ensure the more efficient and safe use of suspensions, it is advisable to install a TOPLINE Protection Kit every time you change shock absorbers, the kit, consisting of a rubber rebound bumper and dust bellows ensures an efficient protection of suspensions and makes driving more silent, comfortable and safe. Below is a list of suitable applications of Protection Kits on TOPLINE SHOCK ABSORBERS. In this catalogue you can also find the reference kit for each vehicle next to the application code.

**TAMPONE
DI FINE CORSA**
**COMPRESSION
BUMPER**

**SOFFIETTO
PARAPOLVERE**
BOOT



PROTECTION KIT
KIT DI PROTEZIONE

ACC11 HD006A/GL NI037A	ACC27 LN019P/GL LN027P/GL	ACC53 CI016A CI016A/GL CI019A CI019A/GL	ACC58 BW012P/GL BW014P/GL BW017P BW017P/GL BW023P/GL	FR023A FR023A/GL FR027A FR027A/GL FR033A FR033A/GL FR034A FR034A/GL FR035A FR035A/GL FR041A FR041A/GL FR048A FR048A/GL FR063A
ACC16 MZ006A/GL	ACC28 LN018P LN018P/GL LN023P LN023P/GL	ACC54 RN040A RN040A/GL RN043A RN043A/GL RN046A/GL RN067A RN067A/GL RN068A RN068A/GL RN071A/GL	ACC59 OG013A OG013A/GL OG015A OG015A/GL OG016A OG016A/GL OG021A OG021A/GL OG024A OG024A/GL OG029A/GL	ACC73 LA003A
ACC18 AS002A AS002A/GL AS003A AS003A/GL AU003A AU003A/GL AU005A AU005A/GL CR001A/GL HD003A/GL HD003P/GL HD005A/GL HD006P/GL MR007A/GL MR008A/GL MT007A/GL MT021A/GL MZ004A/GL MZ004P/GL MZ006P/GL MZ023A/GL NI027A NI028A NI028A/GL NI030A/GL NI030P/GL TY017A/GL TY033P/GL VL002A VL005A VL005A/GL VL006A VL006A/GL	ACC39 LN012A LN012A/GL LN023A LN023A/GL	ACC55 CI019A/GL PG020A PG020A/GL PG021A PG021A/GL PG024A PG024A/GL PG036A PG036A/GL	ACC60 FI078A FI078A/GL FI079A FI079A/GL LN039A/GL	ACC78 FI064A/GL FI087A/GL FI088A/GL FI089A/GL
ACC19 AU012A AU012A/GL FR055A FR055A/GL MT007A/GL MZ001A MZ001A/GL MZ001P MZ001P/GL MZ002P MZ002P/GL MZ006P/GL SB001A/GL TY002P/GL TY003A/GL TY032A/GL TY032P/GL VL003A VW003A VW004A VW008Ac VW008Ac/GL VW029A VW029A/GL	ACC41 VW014P VW018P	ACC56 CI006A CI006A/GL CI016A CI016A/GL CI019A CI019A/GL PG016A PG016A/GL PG020A PG020A/GL PG036A PG036A/GL	ACC61 FI084A/GL	ACC81 FR018A FR018A/GL FR024A/GL
ACC21 FI028A FI028A/GL IN008A ZA001A	ACC42 FI077A FI077A/GL	ACC57 BW007A BW007A/GL BW011A BW012A BW012A/GL BW014A BW014A/GL BW016A BW016A/GL BW017A BW017A/GL BW021A/GL BW022A BW022A/GL BW024A/GL BW025A BW025A/GL BW029A/GL BW030A/GL BW031A/GL BW032A/GL BW033A/GL BW034A/GL BW036A/GL BW041A/GL BW046A/GL BW048A/GL BW050A/GL	ACC62 AU006A AU006A/GL	ACC82 AU005P AU005P/GL
	ACC43 AB006A AB006A/GL FI050A FI050A/GL		ACC63 FI043A FI043A/GL	ACC84 AU003P AU012P AU012P/GL AU015P AU015P/GL BW011P BW011P/GL VW008P VW008P/GL
	ACC44 FI048A FI048A/GL FI049A FI049A/GL SE007A		ACC64 VW008Ac VW008Ac/GL VW016A VW016A/GL VW016Ac VW016Ac/GL VW018A/GL VW021A VW021A/GL VW029A VW029A/GL	ACC88 OG008A OG008A/GL OG013A OG013A/GL OG029A OG029A/GL
	ACC45 AR012A AR012A/GL AR022A AR022A/GL AR027A/GL		ACC65 MZ005A/GL	ACC92 LN019A/GL
	ACC46 AR024A/GL AR028A/GL AR031A/GL		ACC66 MZ005P/GL	ACC95 MT009A/GL
	ACC47 AR030A/GL AR032A/GL AR033A/GL		ACC67 NI017P NI017P/GL	ACC96 HY001A/GL
	ACC48 FI068A/GL LN028A/GL LN037A/GL LN038A/GL		ACC68 AS002P AS002P/GL AS003P AS003P/GL VW016P VW016P/GL VW019P/GL VW022P VW022P/GL VW024P/GL	ACC100 FI143A FI300A FI304A FI320A FI322A
	ACC49 SE002A SE004A SE005A SE005A/GL SE009A SE009A/GL		ACC69 FR017A FR017A/GL FR020A FR020A/GL FR021A FR021A/GL	
	ACC50 VW018A VW018A/GL VW018Ac VW018Ac/GL VW026A VW026A/GL VW028A/GL			
	ACC51 CI014A CI014A/GL			

OIL
GAS

OIL
GAS

MERCEDES (D)

C CLASS (W204/S204)

excl. 4-matic, AMG,	(W204)	01.07 -			MRO28A/GL					MRO28P/GL	$\frac{1}{0}$	
T-Model excl. 4-matic, AMG,	(S204)	08.07 -			MRO28A/GL					MRO28P/GL	$\frac{1}{0}$	
excl. 4-matic, AMG,	(C204)	06.11 -			MRO28A/GL					MRO28P/GL	$\frac{1}{0}$	
4-matic	(W204-S204)	07.07 -			MRO32A/GL					MRO28P/GL	$\frac{1}{0}$	

CL (C140)

200, 230, 320	(C140)	09.92 - 02.99			MRO20A/GL	$\frac{1}{0}$	90			MRO20P/GL	$\frac{1}{0}$	100
---------------	--------	---------------	--	--	-----------	---------------	----	--	--	-----------	---------------	-----

CLC

	(203)	05.08 -			MRO15A/GL					MRO15P/GL	$\frac{1}{0}$	
--	-------	---------	--	--	-----------	--	--	--	--	-----------	---------------	--

CLS

	(C219)	10.04 - 12.10			MRO29A/GL					MRO29P/GL	$\frac{1}{0}$	
--	--------	---------------	--	--	-----------	--	--	--	--	-----------	---------------	--

CLK (A-C208/209)

, 200, 200 K, 230, 230 K, 320	(A208, C208)	06.97 - 06.02			MRO13A/GL	$\frac{1}{0}$	90			MRO13P/GL	$\frac{1}{0}$	100
, 200, 200 CGI, 240, 320, 500	(C209)	06.02 -			MRO15A/GL					MRO15P/GL	$\frac{1}{0}$	
, 200 K, 270 CDi	(A209)	02.03 -										
excl. sportline												

E CLASS (W124/210)

E 200, E 220, E 280, E 320, E 420	(W124)	06.93 - 06.95			MRO07A/GL		105			MRO07P/GL	$\frac{1}{0}$	65
E 200 D, E 250 D, E 250 D Turbo		06.93 - 06.95										
E 300 D, E 350 D Turbo		06.93 - 06.95										
excl. sportline, 4-Matic												
E 280, E 250 D long	(W124)	06.93 - 06.95			MRO07A/GL		105					
E 500	(W124)	06.93 - 06.95			MRO07A/GL		105					
sportline	(W124)	06.93 - 06.95			MRO08A/GL		105			MRO07P/GL	$\frac{1}{0}$	65
E 200 T, E 220 T, E 280 T, E 320	(S124)	06.93 - 06.96			MRO07A/GL		105					
E 250 TD, E 300 TD, E 300 T Turbo D		06.93 - 06.96										
excl. sportline, 4-Matic												
sportline	(S124)	06.93 - 06.96			MRO08A/GL		105					
E 200 C, E 220 C, E 320 C	(C124)	06.93 - 06.97			MRO07A/GL		105			MRO07P/GL	$\frac{1}{0}$	65
excl. sportline												
sportline	(C124)	06.93 - 06.97			MRO08A/GL		105			MRO07P/GL	$\frac{1}{0}$	65
E 220, E 320 excl. sportline	(A124)	06.93 - 03.98								MRO07P/GL	$\frac{1}{0}$	65
sportline	(A124)	06.93 - 03.98								MRO07P/GL	$\frac{1}{0}$	65
E 200, E 220 D excl. ,	(W210)	05.95 - 03.02			MRO10A/GL	$\frac{1}{0}$	90	excl.		MRO10P/GL	$\frac{1}{0}$	100
E 230, E 250 D excl. ,	(W210)	05.95 - 03.02			MRO10A/GL	$\frac{1}{0}$	90	excl.		MRO10P/GL	$\frac{1}{0}$	100
E 280, E 280 TD, E 290 TD excl. ,	(W210)	05.95 - 03.02			MRO10A/GL	$\frac{1}{0}$	90	excl.		MRO10P/GL	$\frac{1}{0}$	100
E 300 D, E 320, E 420 excl. ,	(W210)	05.95 - 03.02										
excl. ,	(S210)	05.95 - 03.03			MRO10A/GL	$\frac{1}{0}$	90				$\frac{0}{0}$	
Avantgarde excl 4-Matic, AMG, ,	(W210)	05.95 - 03.02			MRO12A/GL	$\frac{1}{0}$	90			MRO12P/GL	$\frac{1}{0}$	
Avantgarde excl 4-Matic, AMG, ,	(S210, T210)	05.95 - 03.02			MRO12A/GL	$\frac{1}{0}$	90					

E CLASS (W211/S211)

excl.	(W211)	03.02 - 12.08			MRO16A/GL		130			MRO16P/GL	$\frac{1}{0}$	140
excl.	(S211)	03.03 - 07.09			MRO16A/GL		130			MRO17P/GL	$\frac{1}{0}$	140

OIL
GAS

OIL
GAS

MERCEDES (D)

E CLASS (W212/S212)

excl. 4-matic, AMG,	(W212)	01.09 -			MRO34A/GL					MRO34P/GL	$\frac{1}{0}$	
T-Model excl. 4-matic, AMG,	(S212)	11.09 -			MRO34A/GL					MRO35P/GL	$\frac{1}{0}$	
4-matic excl. AMG,	(W212)	01.09 -			MRO35A/GL					MRO34P/GL	$\frac{1}{0}$	
4-matic excl. AMG,	(S212)	11.09 -			MRO35A/GL					MRO35P/GL	$\frac{1}{0}$	

G CLASS (W460/463)

230 G, 230 GE, 240 GD	(W460)	02.79 - 08.93			MRO25A/GL	$\frac{0}{1}$	60			MRO25P/GL	$\frac{1}{0}$	90
250 GD, 280 GE, 300 GD	(W460)	02.79 - 08.93										
230 GE, 300 GE, 250 GD	(W463)	09.89 -			MRO26A/GL	$\frac{0}{1}$	60			MRO26P/GL	$\frac{1}{0}$	90
300 GD, 350 GD	(W463)	09.89 -										
230 G, 230 GE, 240 GD	(W461)	09.93 -			MRO25A/GL	$\frac{0}{1}$	60			MRO25P/GL	$\frac{1}{0}$	90
250 GD, 280 GE, 300 GD	(W461)	09.93 -										

MB SERIES

90, 100, 120 (made in Spain)	(631)	05.84 - 02.96			MRI08A		$\frac{0}{0}$	60		MRI08P		$\frac{0}{0}$	60
140, 160, 180 (made in Spain)	(631)	05.84 - 02.96			MRI09A		$\frac{0}{0}$	60		MRI09P		$\frac{0}{0}$	60

ML SERIES (W163)

ML 320	(W163)	02.98 - 06.05			MRO30A/GL	$\frac{1}{0}$	150			MRO30P/GL		120
--------	--------	---------------	--	--	-----------	---------------	-----	--	--	-----------	--	-----

ML SERIES (W164)

ML 280, 300, 320, 350	(W164)	07.05 -					150				$\frac{1}{1}$	120
-----------------------	--------	---------	--	--	--	--	-----	--	--	--	---------------	-----

S CLASS (W140)

excl. S 600,	(W140, C140)	02.91 - 02.99			MRO22A/GL	$\frac{1}{0}$			excl.	MRO22P/GL	$\frac{1}{0}$	
--------------	--------------	---------------	--	--	-----------	---------------	--	--	-------	-----------	---------------	--

SL SLC SERIES (C107/R107/R129)

, 380 SL, 500 SL	(R107, C107)	09.80 - 12.85			MRO03A/GL	$\frac{1}{1}$			excl.	MRO03P/GL	$\frac{1}{1}$	
, 300 SL, 420 SL, 500 SL	(R107, C107)	09.85 - 08.89										
, 280 SL, 300 SL	(R107, C107)	05.71 - 08.89			MRO03A/GL	$\frac{1}{1}$			excl.	MRO03P/GL	$\frac{1}{1}$	
, 350 SL, 380 SL, 450 SL	(R107, C107)	05.71 - 08.89										
300 SL, 500 SL	(R129)	03.89 - 1993									$\frac{1}{1}$	
→ Ch. F054767												
SL 280, SL 320, SL 500	(R129)	1993 - 10.01									$\frac{1}{1}$	
Ch. F054768 →												

SLK (R170)

200, 230 K, 320 excl. AMG	(R170)	09.96 - 04.04			MRO23A/GL	$\frac{1}{0}$	60			MRO23P/GL	$\frac{1}{0}$	60
---------------------------	--------	---------------	--	--	-----------	---------------	----	--	--	-----------	---------------	----

SLK (R171)

	(R171)	04.04 - 02.11			MRO27A/GL					MRO27P/GL	$\frac{1}{0}$	
--	--------	---------------	--	--	-----------	--	--	--	--	-----------	---------------	--

SPRINTER

, 200 series	(901, 902, 903)	01.95 - 05.06			MR110A/GL		130		MR110P	MR110P/GL	$\frac{0}{0}$	60
, 300 series		01.95 - 05.06										
, 400 series	(904)	02.96 - 05.06			MR112A	MR112A/GL		130		MR112P	$\frac{0}{0}$	60

MERCEDES



ANTERIORE
FRONT

POSTERIORE
REAR



		OIL	GAS				OIL	GAS		
--	--	------------	------------	--	--	--	------------	------------	--	--

MERCEDES (D)

SPRINTER II

200, 300 Series excl H.D. excl	(906)	06.06 -			MR118A/GL					MR118P/GL		
200 Series incl H.D.	(906)	06.06 -			MR119A/GL							
300 Series incl H.D. incl	(906)	06.06 -			MR118A/GL							
400 Series incl H.D. excl	(906)	06.06 -			MR119A/GL					MR119P/GL		
400 Series incl	(906)	06.06 -			MR119A/GL							
4x4	(906)	02.06 -			MR120A/GL							

V CLASS

excl.	(638)	02.96 - 07.03			MR111A/GL				MR111P	MR111P/GL		
-------	-------	---------------	--	--	-----------	--	--	--	--------	-----------	--	--

VANEO

1.6, 1.9, 1.7 CDI	(414)	02.02 -			MR031A/GL					MR031P/GL		
-------------------	-------	---------	--	--	-----------	--	--	--	--	-----------	--	--

VIANO

excl	(639)	09.03 -			MR114A/GL			5	MR114P	MR114P/GL		
								6		MR117P/GL		

VITO I

excl.	(638)	02.96 - 10.03			MR111A/GL				MR111P	MR111P/GL		
-------	-------	---------------	--	--	-----------	--	--	--	--------	-----------	--	--

VITO II

excl	(639)	09.03 -			MR114A/GL			5	MR114P	MR114P/GL		
								6		MR117P/GL		

5	6
MR114P MR114P/GL A= 46 mm	MR117P/GL A= 40 mm

O 300 SERIES

O 309 B, O 309 D, O 319 B, O 319 D	01.68 -	5	MR115A			25	5	MR115A			25
------------------------------------	---------	----------	--------	--	--	----	----------	--------	--	--	----

O 400 SERIES

O 406, O 407	01.68 -	5	MR115A			25	5	MR115A			25
--------------	---------	----------	--------	--	--	----	----------	--------	--	--	----

O 500 SERIES

O 508 D	01.68 -	4	MR116P			25	4	MR116P			25
---------	---------	----------	--------	--	--	----	----------	--------	--	--	----

OIL
GAS

OIL
GAS

MERCEDES (D)

L 200 SERIES

L 207 D, L 208, L 208 D, L 209 D/DE, L 210, L 210 C/D	(601)	01.78 - 02.96 10.88 - 02.96	❶	MRI07A		0		❷	MRI07P		0	
--	-------	--------------------------------	---	--------	--	---	--	---	--------	--	---	--

L 300 SERIES

L 307, L 307 D, L 308, L 309 D/DC L 310, L 310 C/D	(602)	10.82 - 02.96 06.89 - 02.96	❶	MRI07A		0		❷	MRI07P		0	
L 319, L 319 B/D, L393		01.61 - 02.96	❸	MRI15A		0		❸	MRI15A		0	

L 400 SERIES

L 405, L 405 D L 406, L 406 D, L 406 G, LT 406 (309) L 406 DG, L407 D (309.100 → 309.103) L 406 DG, L407 D (309.111 → 309.116) L 406 DG, L 407 D (309.124 → 309.126) LKO 406 D (309) L 408, L409 (309)		01.61 - 02.96 01.61 - 02.96 01.61 - 02.96 01.61 - 02.96 01.61 - 02.96 01.61 - 12.83 01.61 - 02.96	❸	MRI15A		0		❸	MRI15A		0	
L 406, L 406 D (310) LKO 406 DG (309.130 → 309.135) L 407 DA LKO 407 D (309.130 → 309.135) L 408, L 408 D (310, 611) L 408 G (309.000 → 309.026) L 408 DG (309.300 → 309.303) L 408 DG (309.311 → 309.316) L 408 DG (309.324 → 309.326) LK 408 G, LK 409, LK 410 (309.040, 309.041, 309.044) LKO 408 G, LKO 409 (309.030 → 309.035) L 409 (309.00 → 309.026) L 409 D (309) L 410 (309.000 → 309.026) LP 410 (309)		01.72 - 02.96 01.61 - 02.96 01.61 - 12.83 01.61 - 02.96 01.72 - 02.96 01.72 - 02.96 01.72 - 02.96 01.72 - 02.96 01.72 - 02.96 01.61 - 02.96 01.61 - 02.96 01.72 - 02.96 01.61 - 02.96 01.61 - 02.96 01.61 - 02.96 01.61 - 02.96	❹	MRI16P		0		❹	MRI16P		0	
LF 408 G, LF409, LF 410 (309.050) Ch. 005094 → 148036 Ch. 526087 → LF 408 G (309.054, 309.055) LF 408 G, LF 409, LF 410 (309.056, 309.059) Ch. 185440 → 275292		01.61 - 02.96 01.61 - 02.96 01.61 - 02.96	❹	MRI16P		0		❹	MRI16P		0	
LF 408 G, LF 409 G, LF 410 (309.050) Ch. 148037 → 526086 LF 408 G, LF 409, LF 410 (309.056, 309.059) Ch. 148037 → 185439		01.61 - 02.96 01.61 - 02.96	❹	MRI16P		0		❸	MRI15A		0	
LF 408 G, LF 409, LF 410 (309.056, 309.059) Ch. 275293 → 526086		01.61 - 02.96	❸	MRI15A		0		❸	MRI15A		0	

MERCEDES



ANTERIORE
FRONT

POSTERIORE
REAR



OIL

GAS



OIL

GAS



MERCEDES (D)

L 500 SERIES

L 508 (310)	01.72 - 02.96	④	MR116P		0/0		④	MR116P		0/0	
L 508 DG (309.400 → 309.405)	01.72 - 02.96										
L 508 DG (309.411 → 309.416)	01.72 - 02.96										
L 508 DG (309.424 → 309.429)	01.72 - 02.96										
L 508 DG (310)	01.72 - 02.96										
LF 508 D (310.350)	01.61 - 02.96										
LK 508 DG (309.440/441/442/444/445)	01.61 - 02.96										
LKO 508 DG (309.430 → 309.435)	01.61 - 02.96										

L 600 SERIES

L 608 (310)	01.70 - 02.96	④	MR116P		0/0		④	MR116P		0/0	
L 608 D	01.70 - 02.96										
(310.300 → 310.305)											
(310.311 → 310.316)											
(310.324 → 310.327)											
(310.429)											
L 608 DG (310)	01.70 - 02.96										
LF 608 D (310.350)	01.70 - 02.96										
LK 608 D	01.70 - 02.96										
(310.340 → 310.345)											
(310.440 → 310.445)											
L 613, L 613 D (310, 313)	01.70 - 02.96										

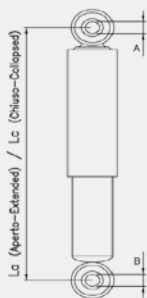

① MR107A
A = 12 mm.
B = 12 mm.
La = 588 mm.
Lc = 350 mm.

② MR107P
A = 14 mm.
B = 12 mm.
La = 485 mm.
Lc = 300 mm.

③ MR115A
A = 14 mm.
B = 14 mm.
La = 588 mm.
Lc = 350 mm.

④ MR116P
A = 14 mm.
B = 14 mm.
La = 626 mm.
Lc = 370 mm.

OIL
GAS

OIL
GAS

MINI (GB)

MINI

One, One D, Cooper incl. excl. Cooper S	(R50)	06.01 - 03.02								BW054P/GL		
One, One D, Cooper excl. Cooper S, Sport Plus	(R50)	03.02 -			BW054AS/GL BW054AD/GL					BW054P/GL		
Cooper S incl. Sport Plus	(R50)	03.02 -			BW055AS/GL BW055AD/GL					BW055P/GL		
One, Cooper, Cooper S		07.04 -			BW055AS/GL BW055AD/GL					BW055P/GL		
	(R56)	09.06 -			BW068AS/GL BW068AD/GL					BW068PS/GL BW068PD/GL		
Clubmann	(R55)	10.07 -			BW068AS/GL BW068AD/GL					BW068PS/GL BW068PD/GL		
Cabriolet	(R57)	11.07 -			BW068AS/GL BW068AD/GL					BW068PS/GL BW068PD/GL		
Coupè	(R58)	09.11 -			BW068AS/GL BW068AD/GL					BW068PS/GL BW068PD/GL		

MITSUBISHI (J)

CARISMA

1.6, 1.9 TD	(DA)	07.95 - 02.99										
1.8, 1.8 GDI, 1.8 16V	(DA)	07.95 - 02.99			VL017AS/GL VL017AD/GL		90			VL017P/GL		80
1.6, 1.8 GDI, 1.9 D-Di	(DA)	03.99 - 06.06			MT018AS/GL MT018AD/GL		90			VL017P/GL		80

COLT II/MIRAGE

1.2, 1.5, 1.6 Turbo 1.8 D	(C1)	02.84 - 05.86 02.84 - 05.86	ACC18		MT021A/GL		85			MT009P/GL		50
1.2, 1.3, 1.5, 1.6 Turbo 1.8 D	(C1)	06.86 - 04.88 06.86 - 04.88	ACC95		MT009A/GL		85			MT009P/GL		50
1.2, 1.3, 1.5, 1.6 Turbo 1.8 D	(C1)	06.86 - 04.88 06.86 - 04.88	ACC95		MT009A/GL		85			MT009P/GL		50

COLT III/MIRAGE

 excl. ABS, 4x4	(C5)	04.88 - 05.92	ACC96		HY001A/GL		85			HY001P/GL		90
--------------------	------	---------------	-------	--	-----------	--	----	--	--	-----------	--	----

COLT IV/MIRAGE

1.3, 1.6, 1.6 4x4	(CA, CC4A)	12.91 - 12.96			MT011AS/GL MT011AD/GL		90			MT011P/GL		90
1.8 GTI	(CA5A)	12.91 - 12.96			MT012AS/GL MT012AD/GL		90			MT011P/GL		80

OIL
GAS

OIL
GAS

MITSUBISHI (J)

COLT V

excl. 4x4	(CJ)	09.95 - 05.97			MT013AS/GL MT013AD/GL		90			MT011P/GL		90
excl. 4x4	(CJ)	06.97 - 07.05			MT014AS/GL MT014AD/GL		90			MT011P/GL		90

COLT VI

excl. 4x4	(Z)	06.04 - 06.12			MT015AS/GL MT015AD/GL					SR004P/GL		
-----------	-----	---------------	--	--	--------------------------	--	--	--	--	-----------	--	--

CORDIA

1.4, 1.5, 1.6, 1.8 excl. 4X4	(A21_A)	10.82 - 12.86		ACC18	MT007A/GL		80		HY002P	HY002P/GL		
------------------------------	---------	---------------	--	-------	-----------	--	----	--	--------	-----------	--	--

ECLIPSE

excl. 4x4	(D21A, D22A)	04.91 - 03.94			MT008A/GL					MT008P/GL		80
4x4	(D27A)	04.91 - 03.94			MT008A/GL					MT016P/GL		
2.0 excl. 4x4	(D32A)	12.95 - 1999			MT017A/GL					MT017P/GL		

GALANT/SIGMA/SAPORO/LAMBDA

1.6, 1.8, 1.8 Turbo	(E11, E14, E16)	09.83 - 08.87		ACC19	MT007A/GL		110			MT020P/GL		145
2.0, 2.0 Turbo	(E15)	09.83 - 08.87										
1.8 Turbo D	(E14)	09.83 - 08.87										
excl.												
1.6, 1.8, 2.0	(E31A, E32A, E33A)	09.87 - 10.92			MT020A/GL		100			MT020P/GL		145
1.8 Turbo D	(E34A)	09.87 - 10.92										
excl. 4X4, 4WS,												
2.0, 2.0 GTI 16V 4X4, incl. 4WS	(E38A, E39A)	06.88 - 10.92								MT016P/GL		
1.8, 2.0	(E52A, E54A, E55A, E64A)	11.92 - 08.96			MT022A/GL		90			MT022P/GL		110
2.0 D, 2.0T D excl.	(E57A)	11.92 - 08.96										
2.0 24V, 2.5 V6 4X4	(E75A, E88A)	11.92 - 08.96										
excl.												
, excl.	(EA)	10.96 - 2004			MT022A/GL		90			MT023P/GL		

GRANDIS

2.4i excl.	(NA 4W)	04.04 -			MT038AS/GL					MT038P/GL		
2.0 Di-D excl.	(NA 8W)	09.05 -			MT038AD/GL							

JEEP

52, J3, J3R		01.54 - 12.75			DA002A/GL					DA002A/GL		
J54, J56, J58		01.74 - 04.77										
J20, J30, J40		01.61 -		FI019P					FI019P			
J54, J56, J57, J58, J59		05.77 -										

OIL
GAS

OIL
GAS

MITSUBISHI (J)

L200

1.6, 2.0, 2.5 D 4X2 (K11T, K12T, K14T)	11.86 - 08.96				MT024A/GL	$\frac{1}{1}$				LAC02P/GL	$\frac{0}{0}$	
2.0, 2.6, 2.5 D 4X4 (K22T, K32T, K33T, K24 5, K34 T)	11.86 - 08.96				MT025A/GL	$\frac{1}{1}$	50			MT025P/GL	$\frac{0}{0}$	50
2.0, 2.4, 2.5 D 4X2 (K62T, K65T, K64T)	01.96 - 03.03				MT026A/GL	$\frac{1}{0}$				LAC02P/GL	$\frac{0}{0}$	
2.4, 2.5 D 4X4 (K74T, K75T)	06.96 - 03.03			MT006A		$\frac{1}{0}$			MT006P	MT025P/GL	$\frac{0}{0}$	
(KA T, KB T)	11.05 -				MT035A/GL	$\frac{1}{1}$				MT035P/GL	$\frac{0}{0}$	

L300

1.6, 2.3 D 4X2 (L032P, L062P, L038P, L068P)	05.80 - 10.86			BE002A		$\frac{1}{1}$	50			DA002A/GL	$\frac{0}{0}$	50
1.8, 2.0 4X4 (L035G, L037G)	05.80 - 10.86			BE002A		$\frac{1}{1}$	50		MT027P		$\frac{0}{0}$	50
1.6, 2.0, 2.5 D 4X2 (P02V, P03V, P05V, P12V, P13V, P15V)	11.86 -			NI060A		$\frac{1}{0}$	50		DA002P		$\frac{0}{0}$	50
2.0 4X4 (P23V, P24V)	11.86 -					$\frac{1}{1}$			DA003P		$\frac{0}{0}$	50
1.6, 2.3 D excl. 4X4 (L032P, L038P)	05.80 - 10.86			BE002A		$\frac{1}{1}$	50				$\frac{0}{0}$	50
1.6 4X2 (L032P)	11.86 - 04.94			BE002A		$\frac{1}{1}$	50		DA002P		$\frac{0}{0}$	
2.5 D 4X2 (L032P, L039P)	11.86 - 04.94			MT027A		$\frac{1}{1}$	50		DA002P		$\frac{0}{0}$	
1.6 4X2 (L032P)	05.80 - 10.86			BE002A		$\frac{1}{1}$	50		DA002P		$\frac{0}{0}$	
1.8, 2.0 4X4 (L035G, L037G)	05.80 - 10.86			BE002A		$\frac{1}{1}$	50		MT027P		$\frac{0}{0}$	
2.3 D 4X2 (L038P)	05.80 - 10.86			BE002A		$\frac{1}{1}$	50			DA002A/GL	$\frac{0}{0}$	50
2.0 2.5 D 4X2 (P03W, P05W)	11.86 -			NI060A		$\frac{1}{0}$	50		DA002P		$\frac{0}{0}$	

LANCER II

1.2, 1.4 (A155A, A156A)	09.82 - 01.84					$\frac{1}{1}$				HY002P	HY002P/GL	$\frac{0}{0}$	
-------------------------	---------------	--	--	--	--	---------------	--	--	--	--------	-----------	---------------	--

LANCER III

1.2, 1.5, 1.8 D (C12, C14, C15)	01.84 - 05.86	ACC18			MT021A/GL	$\frac{1}{1}$	85			MT009P/GL	$\frac{0}{0}$	
1.2, 1.5, 1.8 D (C12, C14, C15)	06.86 - 04.88				MT009A/GL	$\frac{1}{1}$	85			MT009P/GL	$\frac{0}{0}$	
1.5, 1.8 D (C12V, C14V)	01.84 - 05.86				MT021A/GL	$\frac{1}{1}$	85		FI019P		$\frac{0}{0}$	
1.5, 1.8 D (C12V, C14V)	06.86 - 06.92				MT009A/GL	$\frac{1}{1}$	85		FI019P		$\frac{0}{0}$	

LANCER IV

excl. ABS, 4X4 (C6)	04.88 - 04.92				HY001A/GL	$\frac{1}{1}$				HY001P/GL	$\frac{1}{1}$	
---------------------	---------------	--	--	--	-----------	---------------	--	--	--	-----------	---------------	--

LANCER V

1.3, 1.6 incl. 4X4, 2.0 D (CB1A, CB4A, CB8A, CD4A) excl. ABS, 1.8 GTi (CB5A)	05.92 - 11.95	\leftarrow \rightarrow			MT011AS/GL MT011AD/GL	$\frac{1}{1}$ $\frac{1}{1}$	85			MT011P/GL	$\frac{1}{1}$	90
1.8 GTi 16V (CB5A)	05.92 - 12.96	\leftarrow \rightarrow			MT012AS/GL MT012AD/GL	$\frac{1}{1}$ $\frac{1}{1}$	85			MT011P/GL	$\frac{1}{1}$	90
1.6, 2.0 D excl. ABS, 4X4 (CB4W, CB8W)	06.92 - 06.03	\leftarrow \rightarrow			MT011AS/GL MT011AD/GL	$\frac{1}{1}$ $\frac{1}{1}$	85			MT028P/GL	$\frac{0}{0}$	100
1.6 4X4 excl. ABS (CB4W)	06.92 - 06.03	\leftarrow \rightarrow				$\frac{1}{1}$ $\frac{1}{1}$				MT028P/GL	$\frac{0}{0}$	100

OIL
GAS

OIL
GAS

MITSUBISHI (J)

LANCER VI

1.3, 1.5, 1.6, 2.0 excl.	(CK1, CK2, CK4, CP9)	12.95 - 05.97	 		MT013AS/GL MT013AD/GL	 	85			MT011P/GL		70
1.3, 1.5, 1.6 excl.	(CK1, CK2, CK4)	06.97 - 08.03	 		MT014AS/GL MT014AD/GL	 	85			MT011P/GL		70

LANCER VII

1.3, 1.6 excl.	(CS1A, CS3A)	06.03 -			MT036A/GL					MT036P/GL		$\frac{1}{1}$
2.0	(CS9A)	01.04 -								MT036P/GL		$\frac{1}{1}$
1.6, 2.0 excl.	(CS3W, CS9W)	06.03 -			MT036A/GL					MT036P/GL		$\frac{1}{1}$
1.6, 2.0	(CS3W, CS9W)	06.03 -								MT036P/GL		$\frac{1}{1}$

LANCER VIII

1.5, 1.8, 2.0 DI-D excl.	(CY)	01.08 -	 		MT039AS/GL MT039AD/GL	 				MT039P/GL		$\frac{1}{1}$
-----------------------------	------	---------	------	--	--------------------------	------	--	--	--	-----------	--	---------------

OUTLANDER II

2.0, 2.2 HDi, 2.4	(CW)	11.06 -	 		CI031AS/GL CI031AD/GL	 				CI031P/GL		$\frac{1}{0}$
-------------------	------	---------	------	--	--------------------------	------	--	--	--	-----------	--	---------------

PAJERO/SHOGUN/MONTERO

L042G, L043G, L044G L047G, L048G, L049G, P25L	(L04_G)	12.82 - 12.91 01.85 - 12.91			MT001A/GL		$\frac{1}{1}$	50			MT001P/GL		$\frac{1}{0}$	50
L141G, L144G, L146G, L149G	(L14_G)	01.88 - 12.91			MT001A/GL		$\frac{1}{1}$	85			MT003P/GL		$\frac{1}{0}$	75
V21, V23, V24, V25, V26 excl.	(V2_C/W)	12.90 - 04.00			MT004A/GL		$\frac{1}{0}$	50			MT004P/GL		$\frac{1}{0}$	50
V41, V43, V44, V45, V46 excl.	(V4_C/W)	12.90 - 04.00												

PAJERO/SHOGUN/MONTERO

V64W, V65W, V68W V74W, V75W, V78W	(V6_W) (V7_W)	04.00 -			MT029A/GL						MT029P/GL		$\frac{1}{0}$
Pinin, Montero	(H66W, H67W, H77W)	10.99 -			MT010A/GL						MT010P/GL		$\frac{1}{0}$
Sport	(K94W, K96W)	11.98 -			MT004A/GL		$\frac{1}{0}$	50			MT003P/GL		$\frac{1}{0}$
3.2 D, 3.8 V6	(V80, V90)	02.07 -			MT037A/GL						MT037P/GL		$\frac{1}{0}$

SANTAMO

incl. 4x4		03.99 -			MT002A/GL						MT002P/GL		$\frac{1}{1}$
-----------	--	---------	--	--	-----------	--	--	--	--	--	-----------	--	---------------

SIGMA

3.0 V6 excl. ECS	(F16A)	12.90 - 07.96			MT031A/GL						MT031P/GL		$\frac{1}{1}$
3.0 V6 excl. ECS	(F07W)	01.93 - 07.96			MT031A/GL						MT032P/GL		$\frac{1}{0}$

OIL
GAS

OIL
GAS

MITSUBISHI (J)

SPACE GEAR, L400

2.0, 2.4, 2.5 TD 4X2	(PA3W, PA4W, PA5W)	05.95 - 05.00				$\frac{1}{1}$	70				$\frac{0}{0}$	50
2.0, 2.5 TD 4X2	(PA3V/5V, PB3V/5V)	05.95 - 05.00				$\frac{1}{1}$	70		FI019P		$\frac{0}{0}$	50
2.4, 2.5 TD 4X4	(PD4W, PD5W)	05.95 - 05.00				$\frac{1}{1}$	70				$\frac{0}{0}$	50
2.4, 2.5 TD 4X4	(PD4V, PD5V)	05.95 - 05.00				$\frac{1}{1}$	70				$\frac{0}{1}$	50

SPACE RUNNER

incl. 4X4	(N11W, N18W, N21W)	10.91 - 08.99			<u>MT002A/GL</u>		110			<u>MT002P/GL</u>	$\frac{0}{0}$	70
excl. 4x4	(N63, N64)	08.99 -			<u>MT033AS/GL</u>					<u>MT033P/GL</u>	$\frac{1}{1}$	
					<u>MT033AD/GL</u>							

SPACE WAGON

1.6, 1.8, 2.0, 1.8 TD excl. 4X4 (D04W, D05V/W, D09V, D09W)		02.83 - 10.91			<u>MT007A/GL</u>		85		<u>HY002P</u>	<u>HY002P/GL</u>	$\frac{0}{0}$	50
2.0 4X4	(D08W)	02.85 - 10.91							<u>HY002P</u>	<u>HY002P/GL</u>	$\frac{0}{0}$	50
incl. 4X4	(N3_W, N4_W)	11.91 - 10.98			MT002A/GL		110			<u>MT002P/GL</u>	$\frac{0}{0}$	70
incl. 4X4	(N84W, N94W)	06.98 - 05.00			<u>MT034AS/GL</u>					<u>MT034P/GL</u>	$\frac{1}{1}$	
					<u>MT034AD/GL</u>							
incl. 4X4	(N83W, N84W, N94W)	06.00 -			<u>MT034AS/GL</u>					<u>MT034P/GL</u>	$\frac{1}{1}$	
excl. High ground clearance sus.					<u>MT034AD/GL</u>							

TREDIA

1.4, 1.5, 1.6, 1.8 excl. 4X4	(A21_)	09.82 - 07.86			<u>MT007A/GL</u>		80		<u>HY002P</u>	<u>HY002P/GL</u>	$\frac{0}{0}$	50
1.8, 2.0 4x4	(A215G, A217G)	03.85 - 07.86								<u>HY002P/GL</u>	$\frac{0}{0}$	50



NISSAN (J)

100 NX

1.6, 2.0 excl.	(B13)	03.90 - 10.94	 		NI015AS/GL NI015AD/GL	 	150	 		NI013PS/GL NI013PD/GL	 	
----------------	-------	---------------	------	--	--------------------------	------	-----	------	--	--------------------------	------	--

240 MICROBUS

(KC, C, HC, DC, QC, DQC, GHC, GHQ)		01.66 - 09.67			SK001P/GL					DA002A/GL		
(GQC, GC, VC)		01.66 - 09.67			SK001P/GL					SK001P/GL		
(C, KC, HC, DC, QC, DQC, GC, GQC)		10.67 - 09.71								DA002A/GL		
H		10.71 - 12.75								DA002A/GL		

ALMERA

incl. 2.0 GTi	(N15)	07.95 - 07.97	 		NI009AS/GL NI009AD/GL	 	130	2		NI009P/GL		
	(N15)	08.97 - 03.00	 		NI014AS/GL NI014AD/GL	 	90	2		NI014P/GL		
	(N16)	04.00 - 07.00	 		NI018AS/GL NI018AD/GL	 				NI018P/GL		
	(N16E)	01.00 - 07.00	 		NI018AS/GL NI018AD/GL	 				NI034P/GL		
	(N16)	08.00 - 02.01	 		NI018AS/GL NI018AD/GL	 				NI018P/GL		
	(N16E)	08.00 - 08.03	 		NI018AS/GL NI018AD/GL	 				NI034P/GL		
	(N16)	03.01 -	 		NI018AS/GL NI018AD/GL	 				NI034P/GL		
	(N16E)	09.03 -	 		NI034AS/GL NI034AD/GL	 				NI034P/GL		

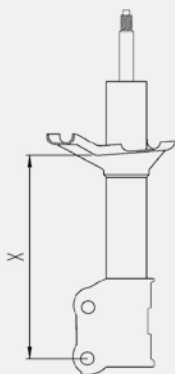

1

NI009AD/GL / NI009AS/GL

X = 215 mm.

NI014AS/GL / NI014AD/GL

X = 244 mm.

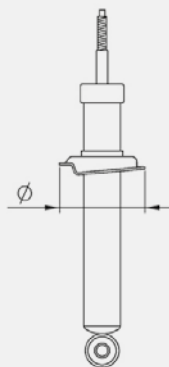

2

NI009P/GL

ø = 93 mm.

NI014P/GL

ø = 103 mm.

OIL
GAS

OIL
GAS

NISSAN (J)

ALMERA TINO

1.8, 2.2 D	(V10)	08.00 - 10.00	← →		NI022AS/GL NI022AD/GL					NI022P/GL		
2.0 16V	(V10)	08.00 - 10.00	← →		NI035AS/GL NI035AD/GL					NI022P/GL		
1.8, 2.2 D	(V10)	11.00 -	← →		NI036AS/GL NI036AD/GL					NI022P/GL		
2.0 16V	(V10)	11.00 -	← →		NI035AS/GL NI035AD/GL					NI022P/GL		

BLUEBIRD

1.6, 1.8, 1.8 Turbo	(U11)	11.83 - 05.90	← →		<u>NI029AS/GL</u> <u>NI029AD/GL</u>				← →	<u>NI030P/GL</u>		180
2.0, 2.0 V6 Turbo, 2.0 D		11.83 - 05.90	← →									
excl.	(U11)	01.86 - 09.90		ACC18	<u>NI030A/GL</u>		195		ACC18	<u>NI030P/GL</u>		180
,	(T12)	12.85 - 12.90		ACC18	<u>NI030A/GL</u>		195		ACC18	<u>NI030P/GL</u>		180
,	(T72)	09.88 - 12.90										
excl. Turbo,												

CABSTAR

	(A320, A321)	1969 - 1975								DA003P		
	(F20)	01.76 - 12.82								FI019P		40
	(F22)	01.82 - 06.92			NI012A/GL							40
	(F23)	07.92 -			NI012A/GL					MTC06A		40
75.28, 90.32		06.98 -			NI065A/GL					NI065P/GL		40

CARAVAN-HOMY/E SERIES

E 20, 21, 22		04.78 - 09.80			<u>NI046A/GL</u>							
E 23		09.80 - 08.86			<u>NI046A/GL</u>					DA003P		

CEDRIC/GLORIA

2.0, 2.4	(130)	1967 - 1971								<u>NI027P</u>	<u>NI027P/GL</u>		
, 220C, 240C, 260C, 280C	(230)	01.72 - 06.75								FI019P			
220 C Diesel	(L230)	01.72 - 06.75								FI019P			
, 200 C, 220 C, 260 C, 280 C	(L230)	06.75 - 06.79								FI019P			

OIL
GAS

OIL
GAS

NISSAN (J)

CHERRY/PULSAR/LANGLEY

100 A, 120 A	(E10)	09.70 - 09.74							<i>NI037P</i>		$\frac{1}{1}$	
100 A	(E10)	01.71 - 09.74							<i>NI038P</i>		$\frac{1}{1}$	
, 100, 120, 140 A FI I	(F10)	09.74 - 07.78		<i>NI037A</i>			195		<i>NI037P</i>		$\frac{1}{1}$	60
100, 120 A FI II	(F10)	09.74 - 07.78		<i>NI037A</i>			195		<i>NI038P</i>		$\frac{1}{1}$	60
, 100 A, 120 A	(N10)	08.78 - 04.82		<i>NI037A</i>			195		<i>NI037P</i>		$\frac{1}{1}$	60
100 A, 120 A	(N10)	08.78 - 04.82		<i>NI037A</i>			195		<i>NI039P</i>	<i>NI039PGL</i>	$\frac{1}{1}$	60
1.3, 1.5, 1.7D excl. 1.5 Turbo	(N12)	04.82 - 10.86			<i>NI040AGL</i>				<i>ARO11P</i>	<i>ARO11PGL</i>	$\frac{1}{1}$	60
1.5 Turbo	(N12)	04.82 - 10.86							<i>ARO11PGL</i>		$\frac{1}{1}$	60

CHERRY/ARNA (EUROPE)

1.2, 1.5 GTI Alfa 33 susp.		08.83 - 12.85	 1 3		<i>ARO22ASGL</i> <i>ARO22ADGL</i>	 			<i>ARO11P</i>	<i>ARO11PGL</i>	$\frac{1}{1}$	60
excl.4X4,	(N13)	06.86 - 09.90		<i>NI017A</i>	<i>NI017AGL</i>				<i>NI017P</i>	<i>NI017PGL</i>		
1.6 4X4	(NN13)	06.86 - 09.90	 		<i>NI041AS/GL</i> <i>NI041AD/GL</i>	 		 		<i>NI041PS/GL</i> <i>NI041PD/GL</i>	 	

1 3

- ① Vedi disegno/nota Alfa 33 a pagina 2
- ⓑ See drawing/note Alfa 33 on page 2
- Ⓕ Voir plan/note Alfa 33 à la page 2
- Ⓖ Siehe Alfa 33 Zeichnung/Anmerkung auf Seite 2
- Ⓔ Ver dibujo/anotación Alfa 33 a la página 2
- Ⓖ Ver figura/nota Alfa 33 na página 2

CLIPPER

662H, 663H		01.69 - 05.76			<i>NI027P</i>	<i>NI027PGL</i>	$\frac{1}{1}$			FI019P		$\frac{1}{1}$	
YT, TWT, YHWT40		01.74 - 12.82								FI019P		$\frac{1}{1}$	

FAIRLADY Z

240 Z, 260 Z	(S30)	01.70 - 06.78			<i>NI028A</i>	<i>NI028AGL</i>							
--------------	-------	---------------	--	--	---------------	-----------------	--	--	--	--	--	--	--

HOMER

Homer 1.5 T	(T641, 642, 20)	01.68 - 12.76					$\frac{1}{1}$			FI019P		$\frac{1}{1}$	
Homer 1.25 T	(T641, T20, F20)	01.68 - 12.81											

INTERSTAR

	(X70)	07.02 -			RN109A	RN109A/GL	$\frac{1}{1}$			RN109P	RN109P/GL	$\frac{1}{1}$	
	(X70)	08.03 -			RN109A	RN109A/GL	$\frac{1}{1}$			RN109P	RN109P/GL	$\frac{1}{1}$	
	(X70)	07.02 -			RN109A	RN109A/GL	$\frac{1}{1}$			<i>RN111P</i>		$\frac{1}{1}$	
	(X70)	08.03 -			RN109A	RN109A/GL	$\frac{1}{1}$			<i>RN111P</i>		$\frac{1}{1}$	

JUKE

	(F15)	06.10 -	 		<i>NI074AS/GL</i> <i>NI074AD/GL</i>	 				<i>NI074P/GL</i>	$\frac{1}{1}$	
--	-------	---------	------	--	--	------	--	--	--	------------------	---------------	--

OIL
GAS

OIL
GAS

NISSAN (J)

KUBISTAR

excl. Pampa, CU+ (800 Kg)	08.03 -		RN064A	RN064A/GL				RN064P	RN064P/GL		
Pampa	08.03 -		RN065A	RN065A/GL				RN063P	RN063P/GL		
CU+ (800 Kg)	08.03 -		RN064A	RN064A/GL				RN065P	RN065P/GL		

LAUREL

1.8 (C30)	01.68 - 02.70		ACC18	<i>NI027A</i>				<i>NI027P</i>	<i>NI027P/GL</i>		
(C130, C131)	01.72 - 01.77		ACC18	<i>NI027A</i>		60					
180 L, 200 L, 260 L, 280 L											
(KC130, KC131)	01.72 - 01.77		ACC18	<i>NI027A</i>		60					
180 L, 200 L, 260 L, 280 L											
(C230, C231)	02.77 - 1980		ACC18	<i>NI027A</i>		60					
180 L, 200 L, 240 L, 260 L, 280 L											
(C31)	1981 - 1985		ACC18	<i>NI027A</i>		60					120
180 L, 200 L, 240 L, 280 L											
180 L, 200 L, 240 L, 280 L (C32)	11.84 - 06.90					255		<i>NI028P</i>	<i>NI028P/GL</i>		120

LEOPARD

1.8 (JF30)	01.80 - 12.82			<i>NI028A</i>	<i>NI028A/GL</i>				<i>NI028P</i>	<i>NI028P/GL</i>		
2.0, 2.8 SFL, 3.0 Turbo (PF30, HF30)	01.80 - 12.82			<i>NI028A</i>	<i>NI028A/GL</i>							

MAXIMA

excl. (J30)	10.88 - 10.94				<i>NI042AS/GL</i>		195	excl.	<i>NI042P/GL</i>		160
excl. (A32)	10.94 - 08.00				<i>NI043AS/GL</i>		195		<i>NI043P/GL</i>		
excl. (CA33)	01.00 - 07.00				<i>NI068AS/GL</i>				<i>NI068P/GL</i>		
excl. (CA33)	08.00 - 11.03				<i>NI069AS/GL</i>				<i>NI069P/GL</i>		

MICRA/MARCH

(K10)	12.82 - 11.92			<i>NI020A</i>			200		<i>NI020P</i>			50
(K11)	08.92 - 02.03			<i>NI004AS</i>	NI004AS/GL		60		<i>NI004P</i>	NI004P/GL		30
(K12)	08.92 - 02.03			<i>NI004AD</i>	NI004AD/GL							
(K12)	01.03 - 05.10				NI021AS/GL					NI021P/GL		
C+C (K12)	08.05 - 06.10				NI021AS/GL					NI021P/GL		

MICRA IV

(K13)	05.10 -				<i>NI072AS/GL</i>					<i>NI072P/GL</i>		
-------	---------	--	--	--	-------------------	--	--	--	--	------------------	--	--

MURANO

(Z50)	03.05 -				<i>NI023AS/GL</i>					<i>NI023P/GL</i>		
-------	---------	--	--	--	-------------------	--	--	--	--	------------------	--	--

OIL
GAS

OIL
GAS

NISSAN (J)

NOTE

	(E11)	03.06 -	 		NI024AD/GL NI024AD/GL	 				NI024P/GL		
--	-------	---------	------	--	--------------------------	------	--	--	--	-----------	--	--

PATHFINDER

	(R50)	09.97 - 01.99	 		NI044AS/GL NI044AD/GL	 				NI044P/GL		
	(R50)	02.99 - 12.04	 		NI070AS/GL NI070AD/GL	 				NI070P/GL		
	(R51)	01.05 -			NI071A/GL					NI071P/GL		

PATROL/SAFARI

	(160, 260)	06.80 - 03.89			NI001A/GL		40			NI001P/GL		50
	(160, 260)	06.80 - 03.89										
160-743, 260-743		04.89 - 02.98			NI002A/GL		50			NI003P/GL		50
160-743, 260-743		04.89 - 02.98										
GR I	(Y60)	08.87 - 06.97			NI002A/GL		50			NI002P/GL		50
GR II	(Y61)	06.97 -		<i>NI045A</i>	NI045A/GL				<i>NI045P</i>	NI045P/GL		

PICK-UP/CAB/KING CAB/NAVARA

	(520, 521, 620)	01.65 - 12.78			<i>NI046A</i> /GL				<i>DA003P</i>			
4X2 incl. King Cab	(720)	10.79 - 08.85			<i>NI047A</i> /GL		50		<i>DA003P</i>			50
4X4 incl. King Cab		10.79 - 12.81										
4X4 incl. King Cab	(720)	01.82 - 08.85			<i>NI047A</i> /GL		50			MT001P/GL		50
4X2	(GD21)	09.85 - 02.98			NI012A/GL		40			NI012P/GL		40
4X4	(MD21)	09.85 - 02.98			NI013A/GL		40			NI012P/GL		40
4X2	(D22)	02.98 - 04.05			<i>NI048A</i> /GL					NI012P/GL		40
4X4	(D22)	02.98 - 04.05			<i>NI049A</i> /GL					<i>NI049P</i> /GL		

PIXO

	(UA0)	06.09 -	 			 						
--	-------	---------	------	--	--	------	--	--	--	--	--	--

PRAIRIE

excl. 4X4	(M10)	08.82 - 10.88			<i>NI040A</i> /GL		180		<i>NI039P</i>	<i>NI039P</i> /GL		
excl. 4X4	(M11)	10.88 - 07.94	 		<i>NI042AS</i> /GL <i>NI042AD</i> /GL	 	195			<i>NI050P</i> /GL		
4X4	(NM11)	10.88 - 07.94	 		<i>NI042AS</i> /GL <i>NI042AD</i> /GL	 	195					

PRIMASTAR

		09.02 -			<i>RN110A</i>	RN110A/GL					RN110P/GL		
--	--	---------	--	--	---------------	-----------	--	--	--	--	-----------	--	--



OIL
GAS

OIL
GAS

NISSAN (J)

PRIMERA

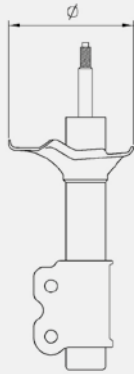
1.6, 2.0 D excl. ABS	(P10)	06.90 - 06.96		<i>NI005A</i>	NI005A/GL				<i>NI005PS</i>	NI005PS/GL		135
1.6, 2.0 D ABS	(P10)	06.90 - 06.96		<i>NI005A</i>	NI005A/GL				<i>NI005PD</i>	NI005PD/GL		
2.0, 2.0 e GT, 2.0 GTi	(P10)	06.90 - 06.96		<i>NI005A</i>	NI005A/GL				<i>NI007PS/GL</i>	<i>NI007PD/GL</i>		135
1.6, 2.0 2.0 D	(W10)	07.90 - 03.98 07.90 - 02.95			NI006AS/GL NI006AD/GL					<i>NI006P/GL</i>		50
 excl. GT, SRi	(P11, WP11)	06.96 - 07.02			NI008A/GL					NI008P/GL		
GT, SRi	(P11, WP11)	06.96 - 07.02			NI008A/GL		100			NI008P/GL		80
	(P12, WP12)	01.02 -			NI026AS/GL NI026AD/GL					<i>NI026P/GL</i>		

1

NI005PS
NI005PD
NI005PS/GL
NI005PD/GL
ø = 152 mm.

2

NI007PS/GL
NI007PD/GL
ø = 170 mm.

QASHQAI/QASHQAI + 2

excl 4x4	(J10)	02.07 -			NI066AS/GL NI066AD/GL					<i>NI066P/GL</i>		
4x4	(J10)	02.07 -			NI066AS/GL NI066AD/GL					<i>NI067P/GL</i>		

QASHQAI II

excl 4x4		02.14 -										
----------	--	---------	--	--	--	--	--	--	--	--	--	--

SERENA

1.6, 2.0 D, 2.3 D (L, LX, SLX) excl. SGX	(C23M)	07.92 - 09.01			NI016AS/GL NI016AD/GL		200			DA002A/GL		30
2.0 SLX, SGX	(C23M)	07.92 - 05.96			NI016AS/GL		200			<i>NI016P/GL</i>		30
2.0 D SGX	(C23M)	07.92 - 09.01			NI016AD/GL							
2.3 D SGX	(C23M)	11.95 - 09.01										
2.0 SE	(C23M)	06.96 - 09.01			NI016AS/GL NI016AD/GL		200			<i>NI051P/GL</i>		

OIL
GAS

OIL
GAS

NISSAN (J)

SILVIA/GAZELLE/200 SX

200 SX		01.75 - 07.79	ACC18	NI027A		/				1/0	
	(S110)	08.79 - 07.83				/				0/0	
	(S12)	08.83 - 04.88	ACC18	NI028A	NI028A/GL	/				1/1	50
1.8 16V Turbo	(S13)	07.88 - 11.94	← →		NI031AS/GL NI031AD/GL	← →			NI031P/GL	← →	
2.0 16V Turbo	(S14)	10.93 - 2000	← →		NI032AS/GL NI032AD/GL	← →			NI032P/GL	← →	

SKYLINE

160 K, 180 K	(C211)	08.77 - 07.81		NI027A		/				1/1	
200 K, 240 K, 280 D											
1.8, 2.0, 2.8 D excl. 2.0 Turbo	(R30)	08.81 - 07.85		NI027A		/				1/1	
2.0 Turbo	(R30)	08.81 - 07.85				/				1/1	
1.8, 2.0	(VR30)	08.81 -		NI027A		/					

STANZA

1.6, 1.8, 1.7 D	(T11)	06.81 - 12.85	ACC18			/	180	ACC18		/	160
1.6, 1.8, 2.0, 2.0 D excl. Turbo	(T12)	01.86 - 12.90	ACC18	NI040A/GL		← →	120	ACC18		/	160

SUNNY/SENTRA

1.2	(B110)	01.70 - 12.74				/				1/0		
1.4 Excellent	(B110)	01.71 - 02.73	ACC18	NI027A		/				1/0		
1.2	(B110, B120)	01.70 - 12.74				/				0/0		
120 Y	(B210)	01.73 - 12.75				/				1/0		
120 Y	(B210)	01.73 - 12.75				/				0/0		
120 Y, 140 Y	(B310)	01.78 - 12.81				/	195			1/0	70	
140 Y	(B310)	01.78 - 12.81				/	195	FI019P		0/0	70	
120 Y, 140 Y	(B310)	01.78 - 12.81				/				0/0		
1.3, 1.5, 1.7 D	(B11)	03.82 - 09.85			NI040A/GL	← →	120	ARO11P	ARO11P/GL	1/0	60	
	(B11)	03.82 - 09.85			NI040A/GL	← →	120	ARO11P	ARO11P/GL	1/0	60	
		01.83 - 12.91										
	(B11)	03.82 - 09.85			NI040A/GL	← →	120		NI052P/GL	1/1	60	
		01.83 - 12.91										
excl. 4X4,	(B12, N13)	09.85 - 10.90		NI017A	NI017A/GL	← →	180	ACC67	NI017P	NI017P/GL	← →	120
4x4	(B12)	06.86 - 09.90	← →		NI041AS/GL NI041AD/GL	← →		← →		NI041PS/GL NI041PD/GL	← →	
1.4, 2.0 D excl.	(N14)	10.90 - 10.95	← →		NI015AS/GL NI015AD/GL	← →	150	← →	NI015PS NI015PD	NI015PS/GL NI015PD/GL	← →	150
1.6, 2.0 excl. 4X4,	(N14)	10.90 - 10.95	← →		NI015AS/GL NI015AD/GL	← →	150	← →		NI013PS/GL NI013PD/GL	← →	

OIL
GAS

OIL
GAS

NISSAN (J)

SUNNY/SENTRA

4x4	(N14)	10.90 - 10.95			NI054AS/GL					NI054PS/GL		
					NI054AD/GL					NI054PD/GL		
excl. 4X4	(Y10)	11.90 - 12.95			NI054S/GL		150			NI055P/GL		50
(Q-BIC) excl. 4X4		12.91 - 12.95			NI054D/GL							
4x4	(Y10)	11.90 - 12.95			NI054AS/GL					NI056P/GL		
					NI054AD/GL							

TERRANO I/PATHFINDER

excl.	(WD21)	07.86 - 02.96			NI010A/GL					NI010P/GL		
	(WD21)	07.86 - 1989										

TERRANO II

excl.	(R20)	10.92 -			NI010A/GL					NI011P/GL		40
-------	-------	---------	--	--	-----------	--	--	--	--	-----------	--	----

TIIDA

excl. 4x4	(SC11X)	09.07 -			NI073AS/GL					NI073P/GL		
					NI073AD/GL							

TRADE

2.0 (made in Spain)		03.87 - 12.00			NI057A					RN109A		
2.8 (made in Spain)		03.87 - 03.93			NI058A					RN109A		
2.8 (made in Spain)		03.87 - 03.93			NI058A					NI058P		
ECO 100		03.87 - 12.00			NI059A					NI059P		

URVAN

	(E20)	04.78 - 06.80								DA003P		40
	(E23)	07.80 - 10.86			NI060A		40			DA003P		40
	(E24)	11.86 - 05.97			NI061A		40			MI027P		40

VANETTE

	(C120, C220)	01.78 - 06.87			NI062A					NI062P		
made in Spain	(C220)	04.87 -										
	(GC22)	10.86 - 12.95			NI063A		50			DA002A		50
	(GC22)	10.86 - 12.95			NI063A		50			NI063P		50
	(GC32M)	01.91 -										

VANETTE CARGO

1.6, 2.0 D, 2.3 D	(C23M)	09.94 -			NI016AS/GL					DA002A/GL		30
excl. SGX					NI016AD/GL							
2.0	(C23M)	09.94 -			NI016AS/GL					NI016P/GL		30
2.0 D, 2.3 D SGX	(C23M)				NI016AD/GL							

VIOLET

140 J, 160 J	(L710)	01.73 - 04.77										
excl. 160 J SSS												
140 J, 160 J SSS	(L710)	01.73 - 04.77								NI027P	NI027P/GL	
140 J, 160 J SSS	(A10)	05.77 - 12.81					240					
160 J	(A10)	05.77 - 12.81					240			FI019P		

OIL
GAS

OIL
GAS

NISSAN (J)

X-TRAIL

	(T30)	07.01 -			NI064AS/GL NI064AD/GL					NI064PS/GL NI064PD/GL		
	(T31)	06.07 -			RN095AS/GL RN095AD/GL					RN095P/GL		

OPEL (D)

ADAM

		10.12 -			OG066AS/GL OG066AD/GL					OG066P/GL		
--	--	---------	--	--	--------------------------	--	--	--	--	-----------	--	--

AGILA

	(H00)	09.00 - 12.07			OG052AS/GL OG052AD/GL				OG052P	OG052P/GL		
	(H08)	04.08 -			SK020AS/GL SK020AD/GL					SK020P/GL		

AMPERA

		11.11 -										
--	--	---------	--	--	--	--	--	--	--	--	--	--

ANTARA

		05.06 -			OG059AS/GL OG059AD/GL					OG059P/GL		
--	--	---------	--	--	--------------------------	--	--	--	--	-----------	--	--

ASCONA A/B

	(81, 84, 86, 87, 88, 89)	1970 - 08.75								OG005P	OG005P/GL		40
	(81, 86, 87, 88)	09.75 - 08.81			OG009A				35	OG005P	OG005P/GL		40

ASCONA C

	(81, 84, 86, 87, 88, 89)	08.81 - 08.84		ACC59	OG015A	OG015A/GL		120		OG013P	OG013P/GL		35
→ Ch. F1003026 → Ch. F5000000 → Ch. F6000000													
		09.84 - 10.88		ACC59	OG021A	OG021A/GL		120		OG013P	OG013P/GL		35
Ch. F1003027→ Ch. F5000001→ Ch. F6000001→													

ASTRA F

, excl. GT, GSi	(53, 54, 56, 57, 58, 59)	09.91 - 03.98		ACC88	OG029A	OG029A/GL		150		OG024P	OG024P/GL		40
, GT	(53, 54, 56, 57, 58, 59)	09.91 - 03.98		ACC88		OG029A/GL		150			OG024P/GL		40
, GSi	(53, 54, 56, 57, 58, 59)	09.91 - 03.98		ACC59		OG029A/GL		150			OG044P/GL		40
Caravan	(51, 52)	09.91 - 03.98		ACC88	OG029A	OG029A/GL		150	excl.	OG034P	OG034P/GL		40
	(53_B)	09.91 - 03.98				OG029A/GL		150			OG024P/GL		40

OIL
GAS

OIL
GAS

OPEL (D)

ASTRA G

, excl. 2.0 OPC	(F48, F08, F69)	04.98 - 03.04		<u>OG04LAS</u> <u>OG04LAD</u>	OG041AS/GL OG041AD/GL		130		<u>OG041P</u>	OG041P/GL		70
 excl. 2.0 OPC	(F35)	04.98 - 08.04		<u>OG04LAS</u> <u>OG04LAD</u>	OG041AS/GL OG041AD/GL		130	excl.	<u>OG042P</u>	OG042P/GL		80

ASTRA H

1.4, 1.6 incl. GTC, , excl. IDS,		03.04 -			OG051AS/GL OG051AD/GL					OG051P/GL		
1.8, 1.3 CDTi, 1.7 CDTi, 1.9 CDTi incl. GTC, , excl. IDS,		03.04 -			OG051AS/GL OG051AD/GL					OG051P/GL		
1.4, 1.6 incl. , excl. IDS,		08.04 -			OG051AS/GL OG051AD/GL					OG065P/GL		
1.8, 1.3 CDTi, 1.7 CDTi, 1.9 CDTi incl. , excl. IDS,		08.04 -			OG051AS/GL OG051AD/GL					OG065P/GL		

ASTRA J

, ,		12.09 -			OG063AS/GL OG063AD/GL					OG063P/GL		
------	--	---------	--	--	--------------------------	--	--	--	--	-----------	--	--

CALIBRA

2.0, 2.0 16V, 2.5 V6 excl. 2.0 Turbo,	(85)	06.90 - 07.97			OG024A/GL		145	excl.		OG028P/GL		45
--	------	---------------	--	--	-----------	--	-----	-------	--	-----------	--	----

CAMPO/BRAVA

TFR Series 4X2	(TF)	08.91 -					60					60
TFS Series 4X4	(TF)	08.91 -			OG055A/GL		60			NI003P/GL		60

COMBO

Kadett E Combo		01.86 - 07.94		ACC88	OG013A	OG013A/GL		140		<u>OG026P</u>			25
Corsa B Combo	(71)	07.94 - 10.01		ACC59	OG016A	OG016A/GL		140		<u>OG026P</u>			25
Corsa C Combo Van, Tour		10.01 -			<u>OG030AS</u> <u>OG030AD</u>	OG030AS/GL OG030AD/GL				<u>OG054P</u>	OG054P/GL		

COMMODORE A/B/C

, 2.2, 2.5		01.67 - 01.72			<u>OG002A</u>					<u>OG001P/GL</u>			
, 2.5, 2.5 GS, 2.8 GS, 2.8 GS/E		01.72 - 07.78			<u>OG002A</u>					<u>OG009P</u>			
, 2.5 S		08.78 - 12.82			<u>OG008A</u>	<u>OG008A/GL</u>		145		<u>OG009P</u>			60

CORSA A

excl. 1.6 GSI		09.82 - 03.93		ACC59	OG016A	OG016A/GL		150		OG016P	OG016P/GL		50
1.6 GSI		05.88 - 03.93		ACC59		OG016A/GL		150			OG016P/GL		50

CORSA B

excl. GSI 1.6 16V		02.93 - 11.00		ACC59	OG016A	OG016A/GL		150		OG016P	OG016P/GL		50
GSI 1.6 16V		02.93 - 11.00		ACC59		OG016A/GL		150			OG016P/GL		50
Combo		07.94 - 10.01		ACC59	OG016A	OG016A/GL		140		<u>OG026P</u>			25



OIL
GAS

OIL
GAS

OPEL (D)

CORSA C

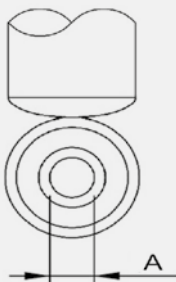
1.0i, 1.2i excl.	(F08, F68)	09.00 -		<u>OG130AS</u>	OG030AS/GL		150	1	<u>OG130P</u>	OG030P/GL	$\frac{1}{0}$	50
				<u>OG130AD</u>	OG030AD/GL							
1.0i, 1.2i	(F08, F68)	09.00 -		<u>OG130AS</u>	OG030AS/GL		150	2	<u>OG153P</u>	OG053P/GL	$\frac{1}{0}$	50
				<u>OG130AD</u>	OG030AD/GL							
1.4i Excl.	(F08, F68)	09.00 -		<u>OG130AS</u>	OG030AS/GL		150	2	<u>OG153P</u>	OG053P/GL	$\frac{1}{0}$	50
				<u>OG130AD</u>	OG030AD/GL							
1.4i	(F08, F68)	09.00 -		<u>OG130AS</u>	OG030AS/GL		150	2		OG053P/GL	$\frac{1}{0}$	50
				<u>OG130AD</u>	OG030AD/GL							
1.7 Di excl.	(F08, F68)	09.00 -		<u>OG130AS</u>	OG030AS/GL		150	1	<u>OG130P</u>	OG030P/GL	$\frac{1}{0}$	50
				<u>OG130AD</u>	OG030AD/GL							
1.7 Di	(F08, F68)	09.00 -		<u>OG130AS</u>	OG030AS/GL		150	2	<u>OG153P</u>	OG053P/GL	$\frac{1}{0}$	50
				<u>OG130AD</u>	OG030AD/GL							
1.8i, 1.7 DTi excl.	(F08, F68)	09.00 -		<u>OG130AS</u>	OG030AS/GL		150	2	<u>OG153P</u>	OG053P/GL	$\frac{1}{0}$	50
				<u>OG130AD</u>	OG030AD/GL							
1.8i, 1.7 DTi	(F08, F68)	09.00 -		<u>OG130AS</u>	OG030AS/GL		150	2		OG053P/GL	$\frac{1}{0}$	50
				<u>OG130AD</u>	OG030AD/GL							
Combo Van, Tour	(F08, W5L)	09.00 -		<u>OG130AS</u>	OG030AS/GL		150		<u>OG154P</u>	OG054P/GL	$\frac{0}{0}$	50
				<u>OG130AD</u>	OG030AD/GL							



1 OG030P
OG030P/GL

A = 10 mm.

2 OG053P
OG053P/GL

A = 15 mm.

CORSA D

	07.06 -			OG057AS/GL					OG057P/GL	$\frac{1}{0}$	
				OG057AD/GL							

FRONTERA A

incl. sport Ch. SV720102	03.92 - 02.95			NI010A/GL	$\frac{1}{0}$	60		<u>OG131P</u>	OG031P/GL	$\frac{0}{0}$	60
incl. sport Ch. SV720103	02.95 - 10.98			OG043A/GL	$\frac{1}{0}$	60		<u>OG131P</u>	OG031P/GL	$\frac{0}{0}$	60

FRONTERA B

incl. sport	10.98 - 12.05			OG047A/GL	$\frac{1}{0}$	60			OG047P/GL	$\frac{1}{0}$	60
-------------	---------------	--	--	-----------	---------------	----	--	--	-----------	---------------	----

INSIGNIA

	07.08 -			OG062AS/GL					OG062P/GL	$\frac{1}{0}$	
				OG062AD/GL							

OIL
GAS

OIL
GAS

OPEL (D)

KADETT A / B

	03.63 - 08.73		<i>OG001A</i>		$\frac{1}{0}$	40			<i>OG001P/GL</i>	$\frac{1}{0}$	40
--	---------------	--	---------------	--	---------------	----	--	--	------------------	---------------	----

KADETT C

SR	08.73 - 07.79		<i>OG009A</i>		$\frac{1}{0}$	50		<i>OG009P</i>		$\frac{1}{0}$	40
GT/E, Rallye	08.73 - 07.79		<i>OG009A</i>		$\frac{1}{0}$	50					
Caravan City	08.73 - 07.79 08.73 - 07.79		<i>OG009A</i>		$\frac{1}{0}$	50			<i>OG001P/GL</i>	$\frac{1}{0}$	40

KADETT D

excl. GTE (31, 34, 41, 44)	08.79 - 08.84	ACC88	OG013A	OG013A/GL		140		OG013P	OG013P/GL	$\frac{1}{0}$	25
GTE (31, 34, 41, 44)	02.83 - 08.84	ACC59		OG013A/GL		140			OG013P/GL	$\frac{1}{0}$	25
(35, 36, 45, 46)	08.79 - 08.84	ACC88	OG013A	OG013A/GL		140		<i>OG014P</i>		$\frac{1}{0}$	25

KADETT E

excl. GSI (33, 34, 39, 43, 43B, 44, 49) → Ch. J 2791967 → Ch. J 5273427	08.84 - 07.88	ACC88	OG013A	OG013A/GL		140		OG013P	OG013P/GL	$\frac{1}{0}$	25
excl. GSI (33, 34, 39, 43, 43B, 44, 49) Ch. J 2791968 → Ch. J 5273428 →	08.88 - 07.91	ACC88	OG013A	OG013A/GL		140		OG024P	OG024P/GL	$\frac{1}{0}$	25
GSI (33, 34, 39, 43, 43B, 44, 49) → Ch. J 2791967 → Ch. J 5273427	08.84 - 07.88	ACC59		OG013A/GL		140			OG013P/GL	$\frac{1}{0}$	25
GSI (33, 34, 39, 43, 43B, 44, 49) Ch. J 2791968 → Ch. J 5273428 →	08.88 - 07.91	ACC59		OG013A/GL		140			OG024P/GL	$\frac{1}{0}$	25
Caravan (35, 36, 45, 46)	08.84 - 07.91	ACC88	OG013A	OG013A/GL		140		OG034P	OG034P/GL	$\frac{1}{0}$	25
Combo (38, 48)	01.86 - 07.94	ACC88	OG013A	OG013A/GL		140		<i>OG026P</i>		$\frac{1}{0}$	25

MANTA A

(58, 59)	09.70 - 08.75				$\frac{1}{0}$			<i>OG009P</i>		$\frac{1}{0}$	45
----------	---------------	--	--	--	---------------	--	--	---------------	--	---------------	----

MANTA B

excl. GT/E, GSI (58, 59)	09.75 - 08.88		<i>OG009A</i>		$\frac{1}{0}$	40		<i>OG009P</i>	<i>OG009P/GL</i>	$\frac{1}{0}$	45
GT/E, GSI (58, 59)	09.75 - 08.88				$\frac{1}{0}$	40			<i>OG009P/GL</i>	$\frac{1}{0}$	45

MERIVA

	05.03 - 05.10	 	<i>OG030AS</i> <i>OG030AD</i>	OG030AS/GL OG030AD/GL	 			<i>OG054P</i>	OG054P/GL	$\frac{1}{0}$	
--	---------------	------	----------------------------------	--------------------------	------	--	--	---------------	-----------	---------------	--

MERIVA B

	06.10 -	 		OG064AS/GL OG064AD/GL	 				OG064P/GL	$\frac{1}{0}$	
--	---------	------	--	--------------------------	------	--	--	--	-----------	---------------	--

OIL
GAS

OIL
GAS

OPEL (D)

MOKKA

excl.4X4,	06.12 -								$\frac{1}{0}$	
-----------	---------	--	--	--	--	--	--	--	---------------	--

MONTEREY

(UBS)	06.92 - 03.95			OG055A/GL	$\frac{1}{0}$	30			OG046P/GL	$\frac{0}{0}$	25
(UBS)	04.95 - 07.98			OG056A/GL	$\frac{1}{0}$	30			OG046P/GL	$\frac{0}{0}$	25
	01.98 -			OG060A/GL	$\frac{1}{0}$				OG060P/GL	$\frac{0}{0}$	

MONZA

(22)	02.78 - 03.83		ACC88	OG008A	OG008A/GL		140			$\frac{1}{0}$	60
(22)	04.83 - 08.86		ACC88	OG008A	OG008A/GL		140			$\frac{1}{0}$	60

MOVANO

2.8T, 3.3T, 3.5T	(E9, F9, J9)	07.98 -		RN109A	RN109A/GL	$\frac{0}{0}$	80		RN109P	RN109P/GL	$\frac{0}{0}$	60
3.5T	(H9, U9)	07.98 -		RN109A	RN109A/GL	$\frac{0}{0}$	80		RN111P		$\frac{0}{0}$	60

OMEGA A

1.8, 2.0, 2.4 excl.	(16, 17, 19)	09.86 - 05.94		OG023A	OG023A/GL		215		OG033P	OG033P/GL	$\frac{1}{0}$	40
2.3 D, 2.3 TD excl.		09.86 - 05.94										
2.6, 2.8, 3.0, 3.0 24V excl. Lotus,	(16, 17, 19)	09.86 - 05.94			OG027A/GL		215			OG033P/GL	$\frac{1}{0}$	40
Caravan excl.	(66, 67)	09.86 - 05.94		OG023A	OG023A/GL		215		OG032P	OG032P/GL	$\frac{1}{0}$	40

OMEGA B

2.0, 2.0 16V, 2.2 16V excl.	(25, 26, 27)	05.94 - 07.03			OG036A/GL		215			OG033P/GL	$\frac{1}{0}$	40
2.0 DTi, 2.2 DTi, 2.5 TD, 2.5 DTi 2.5 V6, 3.0 V6, 3.2 V6 excl.	(25, 26, 27)	05.94 - 07.03 05.94 - 07.03			OG037A/GL		215			OG033P/GL	$\frac{1}{0}$	40
2.0, 2.0 16V, 2.2 16V excl.	(21, 22, 23)	05.94 - 07.03			OG036A/GL		215			OG032P/GL	$\frac{1}{0}$	40
2.0 DTi, 2.2 DTi, 2.5 TD, 2.5 DTi 2.5 V6, 3.0 V6, 3.2 V6 excl.	(21, 22, 23)	05.94 - 07.03 05.94 - 07.03			OG037A/GL		215			OG032P/GL	$\frac{1}{0}$	40

REKORD A / B / C

excl. 2.2, 2.6	01.63 - 12.71			OG002A		$\frac{1}{1}$	35			OG001P/GL	$\frac{1}{0}$	40
----------------	---------------	--	--	--------	--	---------------	----	--	--	-----------	---------------	----

REKORD D

, excl. 2.1 D	01.72 - 08.77			OG002A		$\frac{1}{1}$	35		OG009P		$\frac{1}{0}$	40
2.1 D	01.72 - 08.77			OG002A		$\frac{1}{1}$	35		OG005P	OG005P/GL	$\frac{1}{0}$	40
Caravan	01.72 - 08.77			OG002A		$\frac{1}{1}$	35		OG007P	OG007P/GL	$\frac{1}{0}$	40

REKORD E

1.7, 1.9, 2.0	08.77 - 08.86		ACC88	OG008A	OG008A/GL		130		OG009P		$\frac{1}{0}$	40
2.1 D, 2.2 D, 2.2 TD	08.77 - 08.86		ACC88	OG008A	OG008A/GL		130		OG005P	OG005P/GL	$\frac{1}{0}$	40
Caravan	08.77 - 08.86		ACC88	OG008A	OG008A/GL		130		OG007P	OG007P/GL	$\frac{1}{0}$	40

OIL
GAS

OIL
GAS

OPEL (D)

SENATOR A / B

	(29)	02.78 - 08.87	ACC88	OG008A	OG008A/GL		140				$\frac{1}{6}$	60
excl. 3.0 24V,		09.87 - 04.94		OG023A	OG023A/GL		215		OG033P	OG033P/GL	$\frac{1}{6}$	40
3.0 24V excl.		09.89 - 04.94			OG027A/GL		215			OG033P/GL	$\frac{1}{6}$	40

SIGNUM

→ Ch. 48999999 excl.		05.03 - 08.04			OG049AS/GL			excl.		OG049P/GL	$\frac{1}{6}$	
→ Ch. 48999999 		05.03 - 08.04			OG050AS/GL			excl.		OG050P/GL	$\frac{1}{6}$	
Ch. 51000001 → excl. IDS		09.04 -			OG058AS/GL					OG049P/GL	$\frac{1}{6}$	

SINTRA

		11.96 - 04.99			OG040A/GL		140	excl.		OG040P/GL	$\frac{1}{6}$	60
--	--	---------------	--	--	-----------	--	-----	-------	--	-----------	---------------	----

TIGRA

1.4 16V, 1.6 16V	(95)	07.94 - 12.00	ACC59		OG016A/GL		70			OG016P/GL	$\frac{1}{6}$	30
------------------	------	---------------	-------	--	-----------	--	----	--	--	-----------	---------------	----

TIGRA TWINTOP

		06.04 -			OG030AS/GL					OG030P/GL	$\frac{1}{6}$	
--	--	---------	--	--	------------	--	--	--	--	-----------	---------------	--

VECTRA A

excl. 4X4, 2.0 16V, 2.5 V6	(86_87, 88, 89)	09.88 - 11.95	ACC59	OG024A	OG024A/GL		145	excl.	OG024P	OG024P/GL	$\frac{1}{6}$	40
, 2.0 16V excl. 4X4 → Ch. NV199999 → Ch. N1999999 → Ch. N5999999	(86_87, 88, 89)	09.88 - 11.92	ACC59		OG024A/GL		145	excl.	OG033P	OG033P/GL	$\frac{1}{6}$	40
, 2.0 16V excl. 4X4 Ch. NV199999 → Ch. N1999999 → Ch. N5999999 →	(86_87, 88, 89)	01.93 - 11.95	ACC59		OG024A/GL		145	excl.	OG024P	OG024P/GL	$\frac{1}{6}$	40
, 1.8, 2.0, 2.0 16V Turbo 4X4	(86_87, 88, 89)	09.88 - 11.95	ACC59		OG024A/GL		145	excl.	OG033P	OG033P/GL	$\frac{1}{6}$	40

VECTRA B

























1.6, 1.8, 2.0 1.6 16V, 1.8 16V, 2.0 16V	(36, 38)	08.95 - 03.02		OG038AS	OG038AS/GL		160		OG038P	OG038P/GL		100
1.7 TD, 2.0 Di/DTi 16V, 2.2 DTi 16V 2.5, 2.6 V6	(36, 38)	08.95 - 03.02		OG039AS	OG039AS/GL		160		OG038P	OG038P/GL		100
1.6, 1.8, 2.0 1.6 16V, 1.8 16V, 2.0 16V	(31)	08.95 - 03.02		OG038AS	OG038AS/GL		160	excl.	OG038P	OG038P/GL		100
1.7 TD, 2.0 Di/DTi 16V, 2.2 DTi 16V 2.5 V6, 2.6 V6	(31)	08.95 - 03.02		OG039AS	OG039AS/GL		160	excl.		OG039P/GL		100

OIL
GAS

OIL
GAS

OPEL (D)







VECTRA C

 excl. 3.0 CDTI excl.  ,  ,  , IDS → Ch. 48999999	04.02 - 08.04	 		OG049AS/GL OG049AD/GL	 	70	excl. 		OG049P/GL		60
	 excl. 3.0 CDTI  ,  , excl. IDS → Ch. 48999999	04.02 - 08.04	 		OG050AS/GL OG050AD/GL	 		70	excl. 		OG050P/GL
 Ch. 51000001 → excl. IDS	09.04 -	 		OG058AS/GL OG058AD/GL	 				OG049P/GL		







VIVARO

 , 	(J7, F7)	08.01 -		RN110A RN110A/GL					RN110P/GL		
---	----------	---------	--	---------------------	---	--	--	--	-----------	---	--







ZAFIRA I

	(F75)	04.99 - 07.05	 	OG048AS/GL OG048AD/GL	 	140			OG048P/GL		80
---	-------	---------------	--	--------------------------	--	-----	--	--	-----------	---	----

ZAFIRA II

	(A05)	07.05 -	 	OG051AS/GL OG051AD/GL	 				OG051P/GL		
--	-------	---------	---	--------------------------	---	--	--	--	-----------	--	--

ZAFIRA III

	(P12)	10.11 -	 	OG063AS/GL OG063AD/GL	 				OG063P/GL		
---	-------	---------	--	--------------------------	--	--	--	--	-----------	---	--



OIL

GAS



OIL

GAS



PEUGEOT (F)

104 FRONT



GL, L → Ch. 5675804	(A01)	10.72 - 01.79			<i>C105A</i>	<i>C105AGL</i>		300					
GL6, SL → Ch. 7182579	(A11)	10.72 - 01.79											
ZS → Ch. 5684067	(C12)	09.73 - 02.78											
ZA → Ch. 5684441	(S01)	10.72 - 02.78											
ZL → Ch. 5684483	(C01)	10.72 - 02.78											
GL, L Ch. 5675805 →	(A01)	02.79 - 1985			<i>PG017A</i>			240					
GL6, SL Ch. 7182580 →	(A11)	02.79 - 1985			<i>C1006A</i>	<i>C1006AGL</i>		240					
S Ch. 7178844 →	(A31)	02.79 - 1985											
ZS Ch. 5684068 →	(C31)	04.78 - 1986											
ZA Ch. 5684442 →	(S11)	04.78 - 1986											
ZL Ch. 5684484 →	(C11)	04.78 - 1986											
GR, GLS, SR, ZR, Z, style Z, Sundgau(A11, A21, S11)		04.78 - 06.88											

104 REAR



L, GL → Ch. 5132734	(A01)	10.72 - 12.74											
L, GL Ch. 5132735 → 5534418	(A01)	01.74 - 08.76											
GL6, SL → Ch. 7070747	(A11)	01.74 - 08.76											
L, GL Ch. 5534419 →	(A01)	09.76 - 12.85											
GL6, SL Ch. 7070748 →	(A11)	09.76 - 12.85											
S, GR, SR, Sundgau	(A11, A21, A31)	01.78 - 12.85											
ZL, ZS → Ch. 5534418	(C01, C11, C12, C31)	01.74 - 12.77											
ZL, ZS Ch. 5534419 →	(C01, C11, C12, C31)	01.77 - 12.86											
GLS, ZA, ZR, Z, style Z	(S01, S11)	01.77 - 12.86											

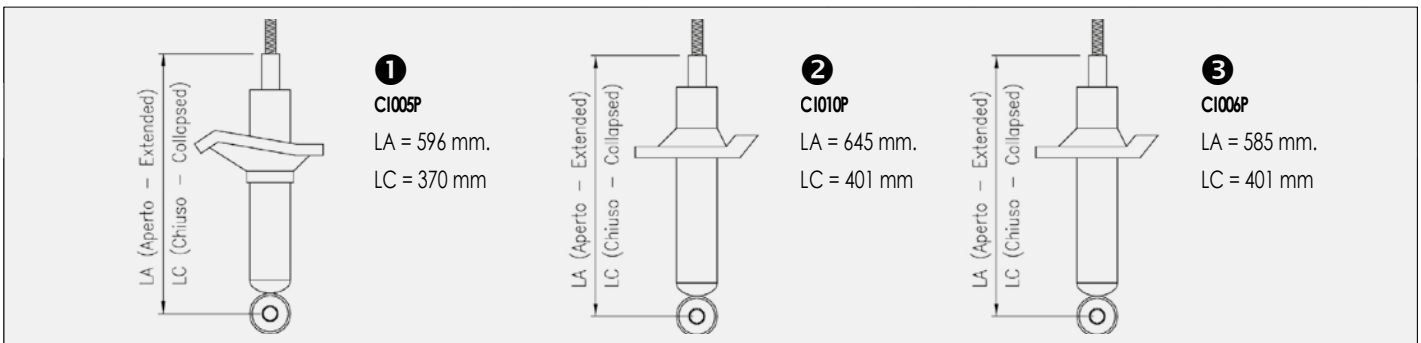

106

0.9, 1.0, 1.1, 1.4, 1.4 D, 1.5 D, Entreprise	(1A, 1C)	09.91 -		ACC52	C1014A	C1014A/GL		80		C1014P	C1014P/GL		40
1.3 Rallye, 1.4 Xsi, 1.6, 1.6 Xsi	(1A, 1C)	09.91 -		ACC52	C1014A	C1014A/GL		80			C1014P/GL		40

107

1.0i, 1.4D		07.05 -		<i>C1027AS</i>	<i>C1027AS/GL</i>					<i>C1027P/GL</i>		
				<i>C1027AD</i>	<i>C1027AD/GL</i>							

204

		10.65 - 01.70								<i>PG002P</i>			
		02.70 - 06.72			<i>PG002A</i>					<i>PG002P</i>			
		07.72 - 07.77			<i>PG002A</i>					<i>PG003P</i>			

OIL
GAS

OIL
GAS

PEUGEOT (F)

205

(741 A/C, 20 A/C) excl. GTi, CTi, Rallye, 1.7 TD, F	02.83 - 09.98	ACC56	PG020A	PG020A/GL		135		PG016P	PG016P/GL		50
1.3 Rallye, 1.6 GTi, 1.9 GTi (741 A/C, 20 A/C)	12.84 - 09.98	ACC55 1 2	PG021AS PG021AD	PG021AS/GL PG021AD/GL		135		PG023P	PG023P/GL		50
1.9 Gentry, 1.7 TD (741 A/C, 20 A/C)	01.90 - 09.98	ACC55 1 2	PG036AS PG036AD	PG036AS/GL PG036AD/GL		180		PG016P	PG016P/GL		50
1.6 CTi, 1.9 CTi (741B, 20D)	04.86 - 12.94	ACC55	PG020A	PG020A/GL		180		PG016P	PG016P/GL		50
F	03.94 -	ACC55	PG020A	PG020A/GL		180					

206

1.1 (2A/C)	09.98 -	1	PG037A	PG037A/GL		150		PG037P	PG037P/GL		50
1.1, 1.4, 1.6, 1.9 D incl. Entreprise (2A/C)	09.98 -	2 1 2	PG039AS PG039AD	PG039AS/GL PG039AD/GL		150		PG039P	PG039P/GL		50
1.4 HDi, 2.0 HDi incl. Entreprise (2A/C)	12.99 -	1 2	PG039AS PG039AD	PG039AS/GL PG039AD/GL		150	N.D. H.D.	PG039P	PG039P/GL PG040P/GL		50
2.0 16V (2A/C)	04.99 -	1 2		PG040AS/GL PG040AD/GL		150			PG040P/GL		50
CC (2D)	09.00 -	1 2		PG040AS/GL PG040AD/GL		150			PG040P/GL		50
SW (2E/K)	07.02 -	1 2	PG039AS PG039AD	PG039AS/GL PG039AD/GL		150	N.D. H.D.	PG039P	PG039P/GL PG040P/GL		50

1

- ① Ammortizzatore senza fissaggio della barra stabilizzatrice.
- Ⓞ Shock without drop link bracket.
- ⓕ Amortisseur sans fixation de la barre stabilisatrice.
- ⓓ Stoßdämpfer ohne Stabilisierungsstangenhalterung.
- ⓔ Amortiguador sin fijación de barra estabilizadora.
- Ⓟ Amortecedor sem fixação de barra estabilizadora.

2

- ① Ammortizzatore con fissaggio della barra stabilizzatrice.
- Ⓞ Shock with drop link bracket.
- ⓕ Amortisseur avec fixation de la barre stabilisatrice.
- ⓓ Stoßdämpfer mit Stabilisierungsstangenhalterung.
- ⓔ Amortiguador con fijación de barra estabilizadora.
- Ⓟ Amortecedor com fixação de barra estabilizadora.

206 +

Plus (T3E)	01.09 -	1 2		PG039AS/GL PG039AD/GL		150			PG039P/GL		50
------------	---------	--------	--	--------------------------	--	-----	--	--	-----------	--	----

OIL
GAS

OIL
GAS

PEUGEOT (F)

207

	(WA, WC, WD, WK)	02.06 -	 	PG049AS/GL PG049AD/GL	 			PG046P/GL		
	(WA, WC, WD, WK)	02.06 -	 	PG046AS/GL PG046AD/GL	 			PG046P/GL		

1

PG046AS/GL
PG046AD/GL
PG055AD/GL
PG055AS/GL

A= Ø 51 mm

2

PG049AD/GL
PG049AS/GL
PG054AD/GL
PG054AS/GL

A= Ø 47 mm

VERIFICARE DIAMETRO MOZZO ORIGINALE
CHECK THE ORIGINAL HUB DIAMETER

208

Excl. GTi	03.12 -	 	PG054AS/GL PG054AD/GL	 			PG054P/GL		
Excl. GTi	03.12 -	 	PG055AS/GL PG055AD/GL	 			PG054P/GL		

304

	10.69 - 02.70						PG002P		150
	03.70 - 06.72		PG002A			330	PG002P		150
	07.72 - 08.77		PG002A			330	PG003P		150
Ch. 4031501 →	08.77 - 10.79		PG009A			330	PG003P		150
S → Ch. 329800	03.70 - 02.73		PG002A			330	PG002P		150
S Ch. 329801 →	03.73 - 04.75		PG002A			330	PG003P		150
	03.70 - 06.72		PG002A			330			
S	07.72 - 07.76		PG002A			330	PG003P		150

305

GL, GR, SR, GLS, GLD, GRD, S, SRD (581A, 581M) → Ch. 8870212	01.77 - 12.82		PG009A			480	PG009P		150
GL, GR, SR, GLS, GLD, GRD, SRD (581A, 581M) Ch. 8870212 → 8987000	01.82 - 06.82		PG009A			480	PG015P		150
GR, SR, GL, GLS (1.1, 1.3, 1.5) (581A, 581M) GLD, GRD, SRD Ch. 8987001 →	07.82 - 12.85 07.82 - 07.90		PG019A	PG019AGL		240	PG015P		150
GL, GLS (1.6) Ch. 9370001 →	(581A, 581M) 01.85 - 07.90		PG019A	PG019AGL		240	PG028P		150
	→ Ch. 8987000 (581D, 581E)	01.78 - 06.82	PG009A			480	PG010P		150
	Ch. 8987001 → (581D, 581E)	07.82 - 07.90	PG019A	PG019AGL		240	PG010P		180

OIL
GAS

OIL
GAS

PEUGEOT (F)

306

1.1 (7A, 7B, 7C, N3, N5)	01.93 - 08.01	← → 	<i>CI016AS</i> <i>CI016AD</i>	CI016AS/GL CI016AD/GL	 	220		PG016P	PG016P/GL	 	55
1.4 (4 �) (7A, 7B, 7C, N3, N5)	06.94 - 05.01	← → 	<i>CI019AS</i> <i>CI019AD</i>	CI019AS/GL CI019AD/GL	 	220		PG016P	PG016P/GL	 	55
1.4 (3/5 �) excl. 175/70x13" excl. 175/65x14"	(7A, 7B, 7C, N3, N5) 01.93 - 08.01	← → 	<i>CI016AS</i> <i>CI016AD</i>	CI016AS/GL CI016AD/GL	 	220	N.D. H.D.	PG016P	PG016P/GL PG025P/GL	 	55 55
1.4 (3/5 �) 175/70x13" 175/65x14"	(7A, 7B, 7C, N3, N5) 01.93 - 08.01	← → 	<i>CI019AS</i> <i>CI019AD</i>	CI019AS/GL CI019AD/GL	 	220	N.D. H.D.	PG016P	PG016P/GL PG025P/GL	 	55 55
1.6, 1.8 1.8 D, 1.9 D, 1.9 TD, 2.0 HDi	(7A, 7B, 7C, N3, N5) 01.93 - 08.01	← → 	<i>CI019AS</i> <i>CI019AD</i>	CI019AS/GL CI019AD/GL	 	220	N.D. H.D.	PG016P	PG016P/GL PG025P/GL	 	55 55
2.0, 2.0 16V (7A, 7B, 7C, N3, N5)	01.93 - 08.01	← → 		CI019AS/GL CI019AD/GL	 	220			PG025P/GL	 	55
(7E, N3, N5)	06.94 - 04.02	← → 	<i>CI019AS</i> <i>CI019AD</i>	CI019AS/GL CI019AD/GL	 	220			PG025P/GL	 	55
(7D, N3, N5)	03.94 - 04.02	← → 		CI019AS/GL CI019AD/GL	 	220			PG016P/GL	 	55
Entreprise	01.93 - 05.99	← → 	<i>CI019AS</i> <i>CI019AD</i>	CI019AS/GL CI019AD/GL	 	220		PG016P	PG016P/GL	 	55

307

1.4, 1.6, 2.0, 2.0 HDi Excl. Commercial,	(3A/C) 08.00 -	← →		PG041AS/GL PG041AD/GL	 	180		PG041P	PG041P/GL	 	
1.4 HDi, 1.6 HDi Excl. Commercial,	(3A/C) 10.01 -	← →		PG043AS/GL PG043AD/GL	 	180		PG041P	PG041P/GL	 	
Commercial 	(3A/C) 08.00 - 08.00 -	← →		PG043AS/GL PG043AD/GL	 	180		PG041P	PG041P/GL	 	
SW Excl. Commercial,	(3E, 3H) 03.02 -	← →		PG041AS/GL PG041AD/GL	 	180			PG041P/GL	 	
SW Commercial 	(3E, 3H) 03.02 - 03.02 -	← →		PG043AS/GL PG043AD/GL	 	180			PG043P/GL	 	
	(3B) 10.03 -	← →		PG041AS/GL PG041AD/GL	 					 	

OIL
GAS

OIL
GAS

PEUGEOT (F)

308

	(4A, 4C)	09.07 -	 		PG050AS/GL PG050AD/GL	 				PG050P/GL	$\frac{1}{0}$	
		09.07 -	 		PG050AS/GL PG050AD/GL	 				PG051P/GL	$\frac{1}{0}$	
		04.09 -	 		PG050AS/GL PG050AD/GL	 				PG051P/GL	$\frac{1}{0}$	

309

	1.1, 1.3, 1.4, 1.8 D, 1.9 D (10C, 10A, 3C, 3A)	10.85 - 12.93		PG020A	PG020A/GL		135	N.D.	PG016P	PG016P/GL	$\frac{0}{0}$	40
	1.6 (XU5), 1.9 (XU9) excl. GTI, GTI 16V	10.85 - 10.89						H.D.		PG025P/GL	$\frac{0}{0}$	
	1.6 (XU5) excl. GTI (10C, 10A, 3C, 3A)	11.89 - 12.93		PG036AS	PG036AS/GL		180	N.D.	PG016P	PG016P/GL	$\frac{0}{0}$	40
	1.9 (XU9) excl. GTI, GTI 16V	08.88 - 12.93		PG036AD	PG036AD/GL			H.D.		PG025P/GL	$\frac{0}{0}$	
	1.8 TD (XUD7T)	08.89 - 12.93										
	1.6i (XU5JA) (10C, 10A, 3C, 3A)	08.88 - 12.93		PG021AS	PG021AS/GL		135		PG025P	PG025P/GL	$\frac{0}{0}$	
	1.9 GTI, GTI 16 (XU9J, XU9J4)	10.86 - 12.93		PG021AD	PG021AD/GL							

405

	1.4, 1.6, 1.8, 1.9 D (GL, GR, SR) (15B, 4B)	01.87 - 10.95		PG024A	PG024A/GL		180		PG024P	PG024P/GL	$\frac{0}{0}$	40
	1.9 GRi, SRi, STi (15B, 4B)	01.87 - 10.95			PG038A/GL		180	N.D.	PG024P	PG024P/GL	$\frac{0}{0}$	40
	1.9 MI-16 excl. 4X4 (15B, 4B)	1987 - 10.95			PG038A/GL		180	H.D.		PG038P/GL	$\frac{0}{0}$	40
	GRX4, SRX4 (15B, 4B)	01.89 - 10.95		PG024A	PG024A/GL		180					
	2.0 MI-16, 2.0 T16 4X4 (15B, 4B)	01.89 - 10.95			PG038A/GL		180					
	1.8 TD (15B, 4B)	03.88 - 10.95		PG038A	PG038A/GL		180		PG024P	PG024P/GL	$\frac{0}{0}$	40
	1.4, 1.6, 1.8, 1.9 D excl. 4X4 (15E, 4E)	10.88 - 10.96		PG024A	PG024A/GL		180		PG024P	PG024P/GL	$\frac{0}{0}$	40
	Entreprise excl. 4X4 (15E, 4E)	10.88 - 10.96			PG038A/GL		180			PG038P/GL	$\frac{0}{0}$	40
	1.9 GRi, SRi, STi, 1.8 TD excl. 4X4 (15E, 4E)	10.88 - 10.96		PG038A	PG038A/GL		180		PG024P	PG024P/GL	$\frac{0}{0}$	40
	4X4 (15E, 4E)	10.88 - 10.96		PG038A	PG038A/GL		180					

406

	1.6, 1.8, 2.0 (8B)	10.95 - 05.04		PG033AS	PG033AS/GL		100		PG033P	PG033P/GL	$\frac{1}{0}$	60
	1.9 D, 1.9 TD, 2.0 HDi	10.95 - 05.04		PG033AD	PG033AD/GL							
	2.0 Turbo (8B)	10.95 - 05.04			PG033AS/GL		100			PG033P/GL	$\frac{1}{0}$	60
	2.1 TD, 2.2 HDi	10.95 - 05.04			PG033AD/GL							
	3.0 V6 (8B)	10.95 - 05.04	 		PG044AS/GL PG044AD/GL	 	100			PG033P/GL	$\frac{1}{0}$	60
	1.6, 1.8, 2.0 (8E/F)	10.96 - 10.04		PG033AS	PG033AS/GL		100		PG034P	PG034P/GL	$\frac{1}{0}$	60
	1.9 D, 1.9 TD, 2.0 HDi	10.96 - 10.04		PG033AD	PG033AD/GL							
	2.0 Turbo (8E/F)	10.96 - 10.04			PG033AS/GL		100			PG034P/GL	$\frac{1}{0}$	60
	2.1 TD, 2.2 HDi	10.96 - 10.04			PG033AD/GL							



		OIL	GAS				OIL	GAS		
--	--	------------	------------	--	--	--	------------	------------	--	--

PEUGEOT (F)

406

3.0 V6 excl.	(8E/F)	10.96 - 10.04			PG044AS/GL PG044AD/GL		100		<u>PG034P</u>	PG034P/GL		60
2.0, 2.2, 3.0 V6 excl.	(8C)	03.97 - 12.04			PG044AS/GL PG044AD/GL		100			<u>PG044P</u> /GL		60
2.2 HDi excl.		03.97 - 12.04										

407

	(6D)	05.04 -			PG047A/GL					PG047P/GL		
	(6E)	05.04 -			PG047A/GL					PG047P/GL		
	(6C)	10.05 -			<u>PG048A</u> /GL					<u>PG048P</u> /GL		

504

L, LD → Ch. 2181356		01.73 - 12.76			<u>PG006A</u>		360		<u>PG007P</u>			
GL, TI, GLD → Ch. 2181356		07.68 - 12.76			<u>PG006A</u>		360		<u>PG006P</u>			
L, LD, GR, GRD, SR, SRD Ch. 2181357 →		01.76 - 12.80					360		<u>PG007P</u>			
GL, TI, GLD Ch. 2181357 →		01.76 - 12.86					360		<u>PG006P</u>			
L, GL, LD, GLD → Ch. 2181356		01.72 - 12.76			<u>PG006A</u>		360		<u>PG013P</u>			60
L, GL, GR, LD, GLD, GRD Ch. 2181357 →		01.76 - 07.86					360		<u>PG013P</u>			60
, → Ch. 2085065		01.68 - 12.76			<u>PG006A</u>		360		<u>PG006P</u>			
, Ch. 2085066 →		01.76 - 08.84					360		<u>PG006P</u>			
	(U01, U20)	01.80 - 05.85						N.D.	<u>PG014P</u>			60
	(U01, U20)	06.85 - 12.89			<u>PG014A</u>		360	N.D.	<u>PG014P</u>			60
Ch. 3972016 →												60

505

excl. 2.2 Turbo → Ch. 1845000	(551A)	05.79 - 12.85					280		<u>PG006P</u>			50
2.2 Turbo → Ch. 1887751		03.84 - 12.86										
excl. 2.8 V6, 2.2 Turbo Ch. 1845001 →	(551A)	01.86 - 12.93		<u>PG011A</u>			360		<u>PG006P</u>			50
2.2 Turbo excl. ABS Ch. 1887752 →		01.87 - 12.93										
2.8 V6, 2.2 Turbo ABS Ch. 1965001 →	(551A)	01.87 - 12.93			<u>PG012A</u> /GL		360		<u>PG006P</u>			50
→ Ch. 1845000	(551D)	04.82 - 12.85					280		<u>PG012P</u>			50
Ch. 1845001 →	(551D)	01.86 - 12.93			<u>PG011A</u>		360		<u>PG012P</u>			50

508

, excl. Hybrid excl.		11.10 -			PG056AS/GL PG056AD/GL					PG056P/GL		
--------------------------	--	---------	--	--	--------------------------	--	--	--	--	-----------	--	--

604

excl. 2.8 GTI	(561A)	01.74 - 07.87					360	excl.	<u>PG006P</u>			90
---------------	--------	---------------	--	--	--	--	-----	-------	---------------	--	--	----

605

excl.	(6B)	10.89 - 09.99			<u>PG027AS</u> <u>PG027AD</u>	<u>PG027AS</u> /GL <u>PG027AD</u> /GL		200		<u>PG027P</u>	<u>PG027P</u> /GL		80
-------	------	---------------	--	--	----------------------------------	--	--	-----	--	---------------	-------------------	--	----

OIL
GAS

OIL
GAS

PEUGEOT (F)

607

excl.	(9D, 9U)	02.00 -	 		PG042AS/GL PG042AD/GL	 				PG042P/GL		
-------	----------	---------	------	--	--------------------------	------	--	--	--	-----------	--	--

806

	(221)	03.94 - 12.97			FI082A/GL		180	4	<i>FI082P</i>	FI082P/GL		70
	(221)	01.98 - 08.02			FI082A/GL		180	5		LN042P/GL		70

807

	(E)	06.02 -	 		LN049AS/GL LN049AD/GL	 				LN049P/GL		
--	-----	---------	------	--	--------------------------	------	--	--	--	-----------	--	--

1007

1.4, 1.6-16V, 1.4 HDI	(KM)	04.05 -	 		CI024AS/GL CI024AD/GL	 				CI024P/GL		
-----------------------	------	---------	------	--	--------------------------	------	--	--	--	-----------	--	--

2008

		03.13 -										
--	--	---------	--	--	--	--	--	--	--	--	--	--

3008

		06.09 -	 		PG052AS/GL PG052AD/GL	 				PG052P/GL		
--	--	---------	------	--	--------------------------	------	--	--	--	-----------	--	--

4007

2.4 16V, 2.2 HDi	(GP)	02.07 -	 		CI031AS/GL CI031AD/GL	 				CI031P/GL		
------------------	------	---------	------	--	--------------------------	------	--	--	--	-----------	--	--

5008

		09.09 -	 		PG053AS/GL PG053AD/GL	 				PG053P/GL		
--	--	---------	------	--	--------------------------	------	--	--	--	-----------	--	--

BIPPER

N.D. Finestrato	(255)	02.08 -	 		FI350AS/GL FI350AD/GL	 				FI350P/GL		
H.D. Cassonato	(255)	02.08 -	 		FI350AS/GL FI350AD/GL	 				FI364P/GL		

BOXER

1000 Kg, 1400 Kg	(230L)	02.94 - 04.02	1	FI320A	FI320A/GL		170	2	FI320P	FI320P/GL		45
1800 Kg	(230L)	02.94 - 04.02	1	FI322A	FI322A/GL		170	2	FI322P	FI322P/GL		45
COMBI	(230P)	02.94 - 04.02	1	FI320A	FI320A/GL		170					
	(244)	04.02 - 05.06	1	FI320A	FI320A/GL		170	2		FI320P/GL		
	(244, Z)	04.02 - 05.06										
1000Kg 1400Kg		04.06 -	1		FI360A/GL			2		FI341P/GL		
1400Kg 2000Kg		04.06 -	1		FI361A/GL			2		FI343P/GL		
1000Kg 1400Kg	REINFORCED	04.06 -	1		FI341A/GL			2		FI341P/GL		
1400Kg 2000Kg	REINFORCED	04.06 -	1		FI342A/GL			2		FI343P/GL		

OIL
GAS

OIL
GAS

PEUGEOT (F)

EXPERT

(→ Ch. 7609)	(222, 223, 224)	07.95 - 12.97		FI082A			90	4	<i>FI082P</i>	FI082P/GL		45
(Ch. 7610 → 9793)	(222, 223, 224)	01.98 -		FI082A			90	5		LND42P/GL		45
(Ch. 9794 → 10408)		10.03 - 05.04	 		CI026AS/GL CI026AD/GL	 		5		LND42P/GL		45
(Ch. 10409 →)		05.04 -		FI082A				5		LND42P/GL		45
1.6D, 2.0 D	(VF3)	01.07 -	 		FI345AS/GL FI345AD/GL	 		6		FI345P/GL		
1.6D, 2.0 D H.D.	(VF3)	01.07 -	 		FI346AS/GL FI346AD/GL	 		7		FI346P/GL		

J5

Ch. → 0244300	(280L, 280P)	09.81 - 12.85	3	FI143A			150	1	FI143P			50
Ch. 0244301 →	(280L, 280P, 290L, 290P)	01.85 - 12.94	3	FI304A			200	1	FI143P			50
excl. 1800kg	(280L)	09.81 - 12.84	3	FI143A			150	1	FI143P			50
excl. 1800kg	(280L)	01.85 - 12.87	3	FI304A			200	1	FI143P			50
excl. 1800kg	(280L, 290L)	01.88 - 12.94	3	FI304A			200	2	FI304P			50

1 2 3	<p>1 Vedi disegno/nota Fiat Ducato a pagina 40/41</p> <p>2 See drawing/note Fiat Ducato on page 40/41</p> <p>3 Voir plan/note Fiat Ducato à la page 40/41</p> <p>4 Siehe Fiat Ducato Zeichnung/Anmerkung auf Seite 40/41</p> <p>5 Ver dibujo/anotación Fiat Ducato a la página 40/41</p> <p>6 Ver figura/note Fiat Ducato na página 40/41</p>	4 5 6 7	<p>4 Vedi disegno/nota Fiat Scudo a pagina 44</p> <p>5 See drawing/note Fiat Scudo on page 44</p> <p>6 Voir plan/note Fiat Scudo à la page 44</p> <p>7 Siehe Fiat Scudo Zeichnung/Anmerkung auf Seite 44</p> <p>8 Ver dibujo/anotación Fiat Scudo a la página 44</p> <p>9 Ver figura/note Fiat Scudo na página 44</p>
--------------	---	----------------	---

J7

	01.66 - 03.80	<i>PG10LA</i>		<i>PG10P</i>	
--	---------------	---------------	--	--------------	--

J9

	03.80 - 12.94	<i>PG10LA</i>		<i>PG10P</i>	
--	---------------	---------------	--	--------------	--

P4

			MRO25A/GL				MRO25P/GL	
--	--	--	-----------	--	--	--	-----------	--

PARTNER / RANCH

excl. 4X4	(5, 5F)	06.96 - 11.02	 	<i>CI019AS</i> <i>CI019AD</i>	CI019AS/GL CI019AD/GL	 	170		PG024P	PG024P/GL		55
	(G)	11.02 -	 		PG039AS/GL PG039AD/GL	 				PG024P/GL		
		04.08 -	 		CI030AS/GL CI030AD/GL	 				CI030P/GL		

OIL
GAS

OIL
GAS

PIAGGIO (I)

PORTER

excl. 16V	1992 -	 	PI001AS PI001AD		 			PI001P			
16V	05.98 -	 	PI001AS PI001AD		 						
excl. 16V	1992 -	 	PI002AS PI002AD		 			PI001P			
16V	05.98 -	 	PI002AS PI002AD		 						

POLSKI (PL)

100

101 P Zastava			FI013A					FI013P			
---------------	--	--	--------	--	--	--	--	--------	--	--	--

125

	1968 - 1978		<i>FI020A</i>								
--	-------------	--	---------------	--	--	--	--	--	--	--	--

126

			FI002A		$\frac{1}{1}$	45		FI002P		$\frac{1}{1}$	45
--	--	--	--------	--	---------------	----	--	--------	--	---------------	----

127

			FI012A			75		FI012P			70
--	--	--	--------	--	--	----	--	--------	--	--	----

132

			<i>FI020A</i>			40		<i>FI021P</i>			70
--	--	--	---------------	--	--	----	--	---------------	--	--	----

FSO

Polonez 1500, 1600, Atou, Caro	06.78 - 07.93		<i>FI020A</i>								
--------------------------------	---------------	--	---------------	--	--	--	--	--	--	--	--

PORSCHE (D)

356

A, B, C, SC	01.56 - 12.65		<i>BE001P</i>								
-------------	---------------	--	---------------	--	--	--	--	--	--	--	--

924

	11.75 - 12.85							<i>PRO03P</i>			
--	---------------	--	--	--	--	--	--	---------------	--	--	--

944

	06.81 - 07.84		<i>PRO03A</i>					<i>PRO03P</i>			
--	---------------	--	---------------	--	--	--	--	---------------	--	--	--

OIL
GAS

OIL
GAS

RENAULT (F)

R 4

	(R1120/1/2/3/4)	01.61 - 08.68				$\frac{1}{0}$				RN002P		$\frac{0}{1}$	85
	(R1120/3/6/C)	09.68 - 12.93		RN003A		$\frac{1}{0}$	110			RN002P		$\frac{0}{1}$	85
	GTL, Rodeo (R1128)	01.73 - 12.93		RN003A		$\frac{1}{0}$	110			RN002P		$\frac{0}{1}$	85
	(R2102/4/5/6)	01.61 - 08.68				$\frac{1}{0}$						$\frac{0}{1}$	75
	F4 (R2105/6/8/9, R2391/2)	09.68 - 12.93		RN003A		$\frac{1}{0}$	105					$\frac{0}{1}$	75
	F6 (R2340/70, R2430)	01.75 - 12.93											

R 5

	excl. Alpine	02.72 - 09.84		RN003A		$\frac{1}{0}$	110			<u>RN039P</u>	<u>RN039PGL</u>	$\frac{1}{0}$	60
	(R1223/122 B) Alpine (R1223/122 B)	03.76 - 09.84		<u>RN039A</u>		$\frac{1}{0}$	110			<u>RN039P</u>		$\frac{1}{0}$	60

SUPER 5

	excl. GT Turbo / GTE (B, C, S)	09.84 - 05.88	1	RN020A	<u>RN020A/GL</u>		195			<u>RN020P</u>	<u>RN020PGL</u>	$\frac{0}{0}$	60
	excl. GT Turbo, GTE (B, C, S)	06.88 - 12.96	1	RN020A	<u>RN020A/GL</u>		195			<u>RN020P</u>	<u>RN020PGL</u>	$\frac{0}{0}$	60
			2	RN044A			195						
	GTE (C409)	01.87 - 12.96		<u>RN045A</u>							<u>RN026PGL</u>	$\frac{0}{0}$	60
	1.4 GT Turbo (C405)	09.84 - 07.85									<u>RN026PGL</u>	$\frac{0}{0}$	60
	1.4 GT Turbo (C405)	08.85 - 05.87		<u>RN045A</u>			195				<u>RN026PGL</u>	$\frac{0}{0}$	60
	1.4 GT Turbo (C405)	06.87 - 05.91		<u>RN027A</u>			195				<u>RN026PGL</u>	$\frac{0}{0}$	60

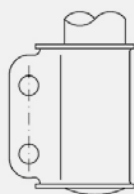
1
**RN020A
RN020A/GL**

O.E.:

77 00 732 743

77 00 732 744

77 00 807 874

77 02 145 522

77 02 145 523

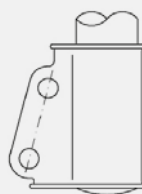
2
RN044A

O.E.:

77 00 786 597

77 00 807 873

77 02 150 468

R 6

	(R1180, R1181)	01.68 - 04.87		RN003A		$\frac{1}{0}$	100			RN002P		$\frac{0}{1}$	75
--	----------------	---------------	--	--------	--	---------------	-----	--	--	--------	--	---------------	----

R 9

	1.1, 1.2, 1.4, 1.6 D (L 421 L 422, L 423, L 424, L 42 S, L42 J)	09.81 - 12.89		RN018A	<u>RN018A/GL</u>					<u>RN018P</u>	<u>RN018PGL</u>	$\frac{1}{0}$	60
	1.7 → Ch. D00000525 (L 42 F/L/N)	09.84 - 12.86											
	1.7 (L 426)	09.84 - 12.86											
	→ Ch. D00003950												
	→ Ch. H00005600												
	1.7 Ch. D00000526 → (L 42 F/L/N)	01.86 - 12.88		RN018A	<u>RN018A/GL</u>					<u>RN019P</u>	<u>RN019PGL</u>	$\frac{1}{0}$	60
	1.7 (L 426)	01.86 - 12.88											
	Ch. D00003951 →												
	Ch. H00005601 →												
	1.7 GTE, 1.4 Turbo (L 42E, L425)	04.84 - 12.89											

OIL
GAS

OIL
GAS

RENAULT (F)

R 11

1.1, 1.2, 1.4, 1.6 D (B/C/S 371, 372, 373, 374, 375, 37 S, 37 J)	03.83 - 07.89		RN018A	<i>RN018A</i> GL				<i>RN018P</i>	<i>RN018P</i> GL	$\frac{1}{6}$	60
1.7 → Ch. D00043789 → Ch. H00017726 → Ch. D00006418	(B/C 376) 10.83 - 12.86										
1.7 → Ch. D00000644 → Ch. D00000509	(B/C 37 F/L/N) 10.84 - 12.86										
1.4 Turbo → Ch. D00001343 → Ch. D00007886 → Ch. E00002300	(B/C 375) 04.84 - 12.86										
1.7 Ch. D00043790 → Ch. H00017727 → Ch. D00006419 →	(B/C 376) 01.86 - 12.87		RN018A	<i>RN018A</i> GL				<i>RN018P</i>	<i>RN018P</i> GL	$\frac{1}{6}$	60
1.7 Ch. D00000645 → Ch. D00000510 →	(B/C 37 F/L/N) 01.86 - 12.88										
1.7 1.4 Turbo excl. Zender	(B 37E, C37E) (B/C 375) 01.86 - 12.88 01.86 - 12.88										
Ch. D00001344 → Ch. D00007887 → Ch. E00002301 →											

R 12

	10.69 - 04.70							<i>RN008P</i>		$\frac{1}{4}$	100
	05.70 - 08.80		<i>RN008A</i>			100		<i>RN008P</i>		$\frac{1}{4}$	100

R 14

 → Ch. 345946 → Ch. 7533	(R1210, R1211) 05.76 - 12.78		<i>CIN05A</i>	<i>CIN05A</i> GL		195		<i>RN003P</i>	<i>RN003P</i> GL	$\frac{1}{6}$	60
 Ch. 345947 → Ch. 7534 →	(R1210, R1211, R1212, R1213) 01.78 - 12.83		<i>RN011A</i>			195		<i>RN003P</i>	<i>RN003P</i> GL	$\frac{1}{6}$	60

R 15

TL, TS (R1300, R1302)	10.71 - 10.80		<i>RN008A</i>					<i>RN008P</i>		$\frac{1}{4}$	
--------------------------	---------------	--	---------------	--	--	--	--	---------------	--	---------------	--

R 16

 (R115)	09.65 - 08.80		<i>RN009A</i>		$\frac{1}{6}$	75		<i>RN009P</i>		$\frac{1}{6}$	85
------------	---------------	--	---------------	--	---------------	----	--	---------------	--	---------------	----

R 17

TL, TS (R1301 → R1328)	04.72 - 10.80		<i>RN008A</i>					<i>RN008P</i>		$\frac{1}{4}$	
---------------------------	---------------	--	---------------	--	--	--	--	---------------	--	---------------	--

OIL
GAS

OIL
GAS

RENAULT (F)

R 18

TS, GTS → Ch. 10709	(R1342)	04.78 - 12.82		<i>RM023A</i>			110		<i>RM012P</i>	<i>RM012PGL</i>	$\frac{1}{1}$	100
TL, GTL → Ch. 552000	(R1340)	04.78 - 12.84		<i>RM012A</i>			110		<i>RM012P</i>	<i>RM012PGL</i>	$\frac{1}{1}$	100
TS, GTS, GTL → Ch. 559400	(R1341)	04.78 - 12.84										
TS, GTS Ch. 10709 → 20609	(R1342)	04.78 - 12.84										
TL	(R1349)	04.78 - 12.82										
TL, GTL Ch. 552001 →	(R1340)	01.84 - 07.86		<i>RM024A</i>			110		<i>RM012P</i>	<i>RM012PGL</i>	$\frac{1}{1}$	100
TS, GTS, GTL Ch. 559401 →	(R1341)	01.84 - 07.86										
TS, GTS Ch. 20610 →	(R1342)	01.84 - 07.86										
TX, GTX → Ch. 3200	(R1343)	04.78 - 12.83		<i>RM023A</i>			110		<i>RM012P</i>	<i>RM012PGL</i>	$\frac{1}{1}$	100
TD, GTD → Ch. 190905	(R1344)	04.78 - 12.84										
TX, GTX Ch. 3201 →	(R1343)	01.83 - 07.86		<i>RM024A</i>			110		<i>RM012P</i>	<i>RM012PGL</i>	$\frac{1}{1}$	100
TD, GTD Ch. 190906 →	(R1344)	01.84 - 07.86										
1.6 Turbo	(R1345, R134A)	10.80 - 07.86		<i>RM024A</i>			110		<i>RM012P</i>	<i>RM012PGL</i>	$\frac{1}{1}$	100
2.1 D Turbo	(R1346)	11.81 - 07.86										
TL → Ch. 122600	(R1350)	05.79 - 12.84		<i>RM012A</i>			110		<i>RM012P</i>	<i>RM012PGL</i>	$\frac{1}{1}$	100
LS, TS, GTS, GTL → Ch. 118200	(R1351)	05.79 - 12.84										
TS, GTS → Ch. 3929	(R1352)	05.79 - 12.83										
TL → Ch. 200	(R1359)	05.79 - 12.82										
TL Ch. 122601 →	(R1350)	01.84 - 07.86		<i>RM024A</i>			110		<i>RM012P</i>	<i>RM012PGL</i>	$\frac{1}{1}$	100
LS, TS, GTS, GTL Ch. 118201 →	(R1351)	01.84 - 07.86										
TS, GTS Ch. 3930 →	(R1352)	01.83 - 07.86										
TL Ch. 201 →	(R1359)	12.82 - 07.86										
TX, GTX → Ch. 2000	(R1353)	05.79 - 12.82		<i>RM023A</i>			110		<i>RM012P</i>	<i>RM012PGL</i>	$\frac{1}{1}$	100
TD, GTD → Ch. 63219	(R1354)	05.79 - 12.84										
TX, GTX Ch. 2001 →	(R1353)	01.82 - 07.86		<i>RM024A</i>			110		<i>RM012P</i>	<i>RM012PGL</i>	$\frac{1}{1}$	100
TD, GTD Ch. 63220 →	(R1354)	01.84 - 07.86										
1.6 Turbo	(R1355, R135A, R135B)	09.82 - 07.86		<i>RM024A</i>			110		<i>RM012P</i>	<i>RM012PGL</i>	$\frac{1}{1}$	100
2.1 D Turbo	(R1356)	01.84 - 07.86										
Société 1.4 → Ch. 4600	(R2350)	05.79 - 12.83		<i>RM012A</i>			110		<i>RM012P</i>	<i>RM012PGL</i>	$\frac{1}{1}$	100
Société 1.4 Ch. 4601 →	(R2350)	01.83 - 07.86		<i>RM024A</i>			110		<i>RM012P</i>	<i>RM012PGL</i>	$\frac{1}{1}$	100
Société 2.1 D → Ch. 3499	(R2354)	10.81 - 12.83		<i>RM023A</i>			110		<i>RM012P</i>	<i>RM012PGL</i>	$\frac{1}{1}$	100
Société 2.1 D Ch. 3500 →	(R2354)	01.83 - 07.86		<i>RM024A</i>			110		<i>RM012P</i>	<i>RM012PGL</i>	$\frac{1}{1}$	100

R 19

excl. 1.8 16V,	(B/C 53, L53)	05.88 - 12.95		<i>RN036A</i>	<i>RN036A/GL</i>		145		<i>RN036P</i>	<i>RN036P/GL</i>	$\frac{1}{0}$	60
, 1.8 16 V	(B/C 53, L53)	05.88 - 12.95			<i>RN042A/GL</i>		145		<i>RM042P</i>	<i>RN042P/GL</i>	$\frac{1}{0}$	60
excl. 1.8 16V	(D53, 853)	07.91 - 06.96		<i>RN036A</i>	<i>RN036A/GL</i>		145		<i>RM042P</i>	<i>RN042P/GL</i>	$\frac{1}{0}$	60
1.8 16V	(D53, 853)	07.91 - 06.96			<i>RN042A/GL</i>		145			<i>RN042P/GL</i>	$\frac{1}{0}$	60

R 20

1.6 L, TL, GTL → Ch. 187000	(R1271)	10.75 - 12.80		<i>RM013A</i>			120		<i>RM013P</i>	<i>RM013PGL</i>		110
1.6 L, TL, GTL Ch. 187001 →	(R1271)	01.81 - 12.83		<i>RM029A</i>			120		<i>RM013P</i>	<i>RM013PGL</i>		110
2.0 LS, TS	(R1272)	10.75 - 12.80		<i>RM014A</i>			120		<i>RM013P</i>	<i>RM013PGL</i>		110
2.0 LS, TS	(R1272)	01.81 - 12.83		<i>RM030A</i>			120		<i>RM013P</i>	<i>RM013PGL</i>		110
2.2 TX	(R1279)	10.80 - 12.83										
2.0 LS, TS	(R1277)	10.80 - 12.83		<i>RM029A</i>			120		<i>RM013P</i>	<i>RM013PGL</i>		100
2.1 D, 2.1 D Turbo	(R1270, R1276)	10.75 - 12.83										

OIL
GAS

OIL
GAS

RENAULT (F)

R 21

, L, TL, GTL (B/L 481)	03.86 - 06.94		RN031A			195		RN031P	<i>RN031PGL</i>		60
, RS, TS, GTS, TSE (B/L 482)	03.86 - 06.94										
, TL, GTL, TS, GTS (B/L 48 D/E/F)	03.86 - 06.94										
TL, GTL, RS, GTS (B/L 48 M/N)	03.86 - 06.94										
TX, GTX, GTS (L48J)	03.86 - 06.94										
, SD, GSD (B/L 48H)	03.86 - 06.94										
, RX, TI, TL, GTX, TXE 4X2 (B/L 48K)	03.86 - 06.94		<i>RN032AS</i>			195		RN031P	<i>RN031PGL</i>		60
, RX, TI, GTX, TXE (B/L 483, B/L 489)	03.86 - 06.94		<i>RN032AD</i>								
GTX, TXE (L48S)	03.86 - 06.94										
, TD, GTD (B/L 486)	03.86 - 06.94										
, TBD, TDX (B/L 488, 48L)	03.86 - 06.94										
, RX, TI, TL, GTX, TXE 4X2 (B/L 48 K/Y)	03.86 - 06.94		<i>RN033AS</i>			195		RN031P	<i>RN031PGL</i>		60
, RX, TI, GTX, TXE (B/L 483, 489)	03.86 - 06.94		<i>RN033AD</i>								
TXI 4X2 (L48Q)	03.86 - 06.94										
GTX, TXE (L48S)	03.86 - 06.94										
, TD, GTD (B/L 486)	03.86 - 06.94										
, GTD (B/L 48V)	03.86 - 06.94										
, TBD, TDX (B/L 488, 48L)	03.86 - 06.94										
2.0 Turbo incl. 4X4 (L485)	04.87 - 10.93										
Nevada (K481, K482)	03.86 - 08.94		RN031A			195		<i>RN034P</i>	<i>RN034PGL</i>		60
Nevada (K48 E/F/H/M/N)	03.86 - 08.94										
Soci�t� (S481, S482, S48H)	03.86 - 08.94										
Nevada 4X2 (K480, K483)	03.86 - 08.94		<i>RN032AS</i>			195		<i>RN034P</i>	<i>RN034PGL</i>		60
Nevada 4X2 (K 486/488/489)	03.86 - 08.94		<i>RN032AD</i>								
Nevada 4X2 (K48 K/V)	03.86 - 08.94										
Soci�t� (S486, S48V)	03.86 - 08.94										
Nevada 4X2 (K480, K483)	03.86 - 08.94		<i>RN033AS</i>			195		<i>RN034P</i>	<i>RN034PGL</i>		60
Nevada 4X2 (K486, K488)	03.86 - 08.94		<i>RN033AD</i>								
Nevada 4X2 (K48 K/V)	03.86 - 08.94										
Nevada (K48S)	03.86 - 08.94										

R 25

excl. 2.7 V6, 2.8 V6	11.83 - 12.93		<i>RN025A</i>	<i>RN025AGL</i>		200		<i>RN025P</i>	<i>RN025PGL</i>		120
2.7 V6, 2.8 V6 (B298, B29A)	11.83 - 08.89										
2.8 V6 excl. Auto.,	06.87 - 12.92										
2.4 V6 Turbo (B295)	10.84 - 05.90										
2.8 V6 Auto. excl.	06.87 - 12.92							<i>RN025P</i>	<i>RN025PGL</i>		120
2.5 V6 Turbo excl.	01.90 - 12.92										

OIL
GAS

OIL
GAS

RENAULT (F)

CLIO I

1.9 D (B/C/S 57I, B/S 576)	01.91 - 12.93	ACC54	RN043A	RN043A/GL		145		RN040P	RN040P/GL		60
1.9 D (B/C 57U)	01.91 - 12.93	2 - 4									
1.9 D 3 \square (C57I, S57I)	01.94 - 05.97	ACC54	RN040A	RN040A/GL		145		RN040P	RN040P/GL		60
		1 - 4									
1.9 D 5 \square (B57I)	01.94 - 05.97	ACC54	RN043A	RN043A/GL		145		RN040P	RN040P/GL		60
		2 - 4									
2.0 16V Williams (C57M)	01.94 - 09.98		<i>RN050A</i>			145			<i>RN050P/GL</i>		
	05.97 - 03.98	3	RN066A	RN066A/GL		145		RN040P	RN040P/GL		60

1

RN040A
RN040A/GL
O.E.:
77 00 808 490
77 00 816 045
77 00 823 130
77 00 828 680
77 00 838 084

2

RN043A
RN043A/GL
O.E.:
77 00 808 491 / 77 00 808 492
77 00 816 046 / 77 00 823 129
77 00 823 131 / 77 00 828 681
77 00 828 682 / 77 00 828 683
77 00 828 684 / 77 00 838 083
77 00 838 085 / 77 00 838 086
77 00 838 087 / 77 00 838 088

3

RN066A
RN066A/GL
O.E.:
77 00 423 726
77 00 423 727
77 00 423 729

4

OLD
VECCHIO

NEW
NUOVO

CLIO II

1.2, 1.2 16V (B/C/B0/1)	03.98 -	ACC54	RN067A	RN067A/GL		150		RN067P	RN067P/GL		80
1.4, 1.4 16V, 1.6, 1.5 dCi, 1.9 D, 1.9 dTi (B/C/B0/1)	03.98 -	ACC54	RN068A	RN068A/GL		150		RN067P	RN067P/GL		80
1.6 16V (CB0T)	03.98 -	ACC54		RN071A/GL		150			RN067P/GL		80
2.0 RS (CB0M)	02.00 -			<i>RN073A/GL</i>		150			RN067P/GL		80
3.0 V6 RS	11.00 -			<i>RN074A/GL</i>		150			RN067P/GL		80

CLIO III

1.2 (BR0/1, CR0/1)	06.05 -			RN081A/GL					RN081P/GL		
1.4, 1.5 D, 1.6 (BR0/1, CR0/1)	06.05 -			RN081A/GL					RN081P/GL		
2.0 (BR0/1, CR0/1)	01.06 -			RN085A/GL					RN085P/GL		
Grandtour (KR0/1)	02.08 -			RN081A/GL							

CLIO IV

excl. RS	11.12 -			<i>RN200A/GL</i>					<i>RN200P/GL</i>		
Grandtour	01.13 -			<i>RN200A/GL</i>							



		OIL	GAS				OIL	GAS		
--	--	------------	------------	--	--	--	------------	------------	--	--

RENAULT (F)

ESPACE I

2.0 → Ch. T005812	(J112)	07.84 - 12.84									RN035P/GL		60
	(J112, J115, J117)	01.85 - 12.87		<i>RN035A</i>			150				RN035P/GL		60
excl.	(J112, J115, J116, J117)	01.88 - 12.90		<i>RN057A</i>	RN057A/GL		150				RN035P/GL		60

ESPACE II

excl. 2.8 V6, Quadra 4X4,	(J63)	01.91 - 10.96		<i>RN057A</i>	RN057A/GL		150				RN035P/GL		60
2.8 V6 excl. Quadra 4X4,	(J638)	01.91 - 10.96			<i>RN069A/GL</i>		150				RN035P/GL		60

ESPACE III

excl. Grand Espace	(JE)	11.96 - 10.02			RN060A/GL					excl.	RN060P/GL		
Grand Espace	(JEO)	01.97 - 12.02			RN060A/GL						RN092P/GL		

ESPACE IV

	(JK0)	11.02 -			RN088A/GL						RN088P/GL		
--	-------	---------	--	--	-----------	--	--	--	--	--	-----------	--	--

EXPRESS / EXTRA / RAPID / COMBI

excl. CU+ (775Kg)	(F40, G40)	07.85 - 09.96		RN028A			195				RN028P/GL		60
excl. CU+ (775Kg)	(F40, G40)	10.96 - 03.98		RN062A			195				RN028P/GL		60
CU+ (775Kg)	(F40, G40)	01.91 - 09.96		RN028A			195				RN061P/GL		60
CU+ (775Kg)	(F40, G40)	10.96 - 03.98		RN062A			195				RN061P/GL		60

FUEGO

		02.80 - 10.85		<i>RN024A</i>			115			<i>RN012P</i>	<i>RN012P/GL</i>		95
--	--	---------------	--	---------------	--	--	-----	--	--	---------------	------------------	--	----

KANGOO

excl. Pampa, CU+ (800 Kg)	(KCO, FCO)	04.98 -		RN064A	RN064A/GL		150			RN064P	RN064P/GL		60
Pampa	(KCO, FCO)	04.98 -		RN065A	RN065A/GL		150			RN063P	RN063P/GL		60
CU+ (800 Kg)	(KCO, FCO)	04.98 -		RN064A	RN064A/GL		150			RN065P	RN065P/GL		60
4X4	(KCO, FCO)	10.01 -			<i>RN098A/GL</i>						<i>RN098P/GL</i>		60

KANGOO II

incl. Express, Grand Kangoo	(FW0/1)	02.08 -	1		<i>RN096A/GL</i>						RN096P/GL		
			2		<i>RN099A/GL</i>								

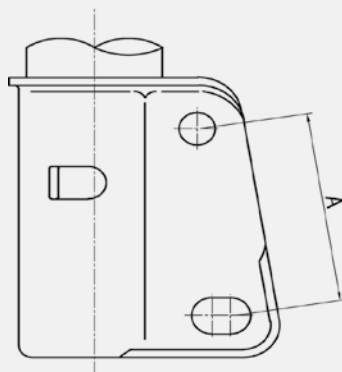

1

RN096A/GL
A = 60 mm Body Ø47

2

RN099A/GL
A = 75 mm Body Ø52



OIL

GAS



OIL

GAS



RENAULT (F)

KOLEOS

2.0 dCi, 2.5 incl 4x4 (HY)	09.08 -			RN095AS/GL					RN095P/GL		
				RN095AD/GL							

LAGUNA I

1.6 (B56 A/B/S/Z)	11.97 - 03.01	1	RN052A	RN052A/GL		130		RN051P	RN051P/GL		45
1.8 RN, RT, RXE (B56C, B56H)	12.93 - 02.95										
2.0 RT, RXE, Baccara (B56E, B56R)	12.93 - 02.95										
3.0 V6 RT, RTI, Baccara (B56E, B56R)	12.93 - 03.01										
1.9 dTi	10.97 - 03.01										
2.2 D, 2.2 dT RN, RT, RXE (B56F/B56Z)	12.93 - 03.01										
1.6 (B56 A/B/S/Z)	11.97 - 03.01	2	RN051A	RN051A/GL		130		RN051P	RN051P/GL		45
1.8 RN, RT, RXE (B56 T/O)	02.95 - 03.01										
1.8 RN, RT excl. ABS (B56 T/O)	02.95 - 03.01										
2.0 excl. ABS, Auto. (B56L)	02.95 - 03.01										
2.0 excl. ABS (B56 C/H)	02.95 - 03.01										
1.8 RN, RT ABS (B56 T/O)	02.95 - 03.01	1	RN052A	RN052A/GL		130		RN051P	RN051P/GL		45
2.0 ABS, Auto. (B56L)	02.95 - 03.01										
2.0 RN, RT, RXE, RTI (B56 D/M)	02.95 - 03.01										
2.0 ABS (B56 C/H)	02.95 - 03.01										
Nevada (K56)	09.95 - 03.01	1	RN052A	RN052A/GL		130	excl.	RN053P	RN053P/GL		45
excl. 3.0 V6,											
Nevada 3.0 V6 - excl.	(K56) 02.96 - 03.01	1	RN052A	RN052A/GL		130	excl.				

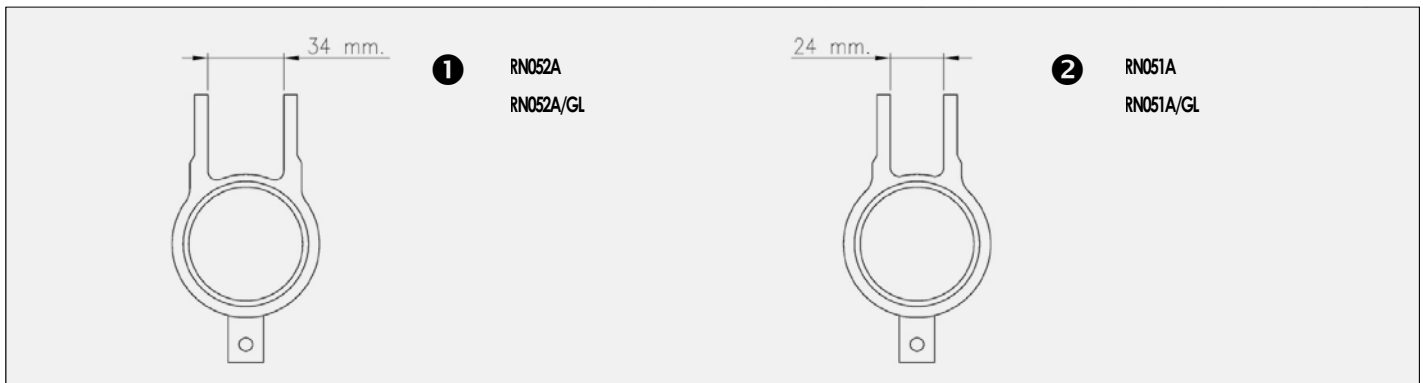

LAGUNA II

(BG0/1)	03.01 -			RN072A/GL					RN075P/GL		40
(KG0/1)	03.01 -			RN072A/GL					RN072P/GL		40

LAGUNA III

(BT0/1, KT0/1)	10.07 -			RN093A/GL					RN093P/GL		
----------------	---------	--	--	-----------	--	--	--	--	-----------	--	--

MASTER Q-SERIES

(T_, P_)	05.80 - 03.98			RN104A					RN104P		
----------	---------------	--	--	--------	--	--	--	--	--------	--	--

OIL
GAS

OIL
GAS

RENAULT (F)

MASTER R-SERIES

(R2, R4) (T_) 05.80 - 03.98		<i>RN104A</i>		$\frac{1}{0}$	160		<i>RN106P</i>		$\frac{1}{1}$	
(R3) excl. Minicar 05.80 - 03.98										
(R3) Minicar (T_) 05.80 - 02.89		<i>RN104A</i>		$\frac{1}{0}$	160				$\frac{1}{1}$	
(RC/RD/RL 9) (P_) 05.80 - 03.98		<i>RN104A</i>		$\frac{1}{0}$	160		<i>RN104P</i>		$\frac{0}{0}$	
excl. Minicar (T_) 03.89 - 03.98		<i>RN104A</i>		$\frac{1}{0}$	160		<i>RN106P</i>		$\frac{1}{1}$	
Minicar (T_) 03.89 - 03.98		<i>RN104A</i>		$\frac{1}{0}$	160					

MASTER II

, 2,8T (FD, JD) 07.98 -		RN109A	RN109A/GL	$\frac{0}{0}$	80		RN109P	RN109P/GL	$\frac{0}{0}$	60
, , 3T, 3,5T (ED, FD, JD) 07.98 -										
3,5T (HD, UD) 07.98 -		RN109A	RN109A/GL	$\frac{0}{0}$	80		<i>RN111P</i>		$\frac{0}{0}$	60

MASTER III

(JV) 02.11 -					80				$\frac{0}{0}$	60
(FV) 02.10 -									$\frac{0}{0}$	
(EV, HV, UV) 02.10 -					80				$\frac{0}{0}$	60

MÉGANE I

, Classic (BA) 09.95 - 12.02		RN054A	RN054A/GL		100		<i>RN054P</i>	RN054P/GL	$\frac{0}{0}$	35
excl. 2.0 16V										
2.0 16V (BA) 09.95 - 12.02			RN055A/GL		100			RN055P/GL	$\frac{0}{0}$	35
(KA) 01.98 - 06.99		RN054A	RN054A/GL		100			RN078P/GL	$\frac{0}{0}$	35
(KA) 07.99 -		RN054A	RN054A/GL		100		<i>RN078P</i>	RN078P/GL	$\frac{0}{0}$	35
(DA0/1) 10.96 - 12.02		RN054A	RN054A/GL		100		<i>RN054P</i>	RN054P/GL	$\frac{0}{0}$	35
excl. 2.0, 2.0 16V										
2.0, 2.0 16V (DA0/1) 10.96 - 10.98			RN055A/GL		100			RN055P/GL	$\frac{0}{0}$	35
2.0, 2.0 16V (DA0/1) 11.98 - 12.02			<i>RN077A/GL</i>		100			RN055P/GL	$\frac{0}{0}$	35
(EA0) 10.96 - 12.02		RN054A	RN054A/GL		100			RN055P/GL	$\frac{0}{0}$	35
excl. 2.0, 2.0 16V										
2.0, 2.0 16V (EA0) 10.96 - 10.98			RN055A/GL		100			<i>RN077P/GL</i>	$\frac{0}{0}$	35
2.0, 2.0 16V (EA0) 11.98 - 12.02			<i>RN077A/GL</i>		100			<i>RN077P/GL</i>	$\frac{0}{0}$	35

MÉGANE II

1.4, 1.6, 2.0, 1.5 dCi, 1.9 dCi (BM0/1, CM0/1) 09.02 -			RN079A/GL		60			RN079P/GL	$\frac{0}{0}$	50
excl.										
(BM0/1, CM0/1) 09.02 -							O.E. 8200122947	RN086P/GL	$\frac{0}{0}$	50
1.4, 1.6, 2.0 excl. (LM0/1) 09.03 -			RN079A/GL		60			RN079P/GL	$\frac{0}{0}$	50
1.5 dCi, 1.9 dCi excl. (LM0/1) 09.03 -			RN080A/GL		60			RN079P/GL	$\frac{0}{0}$	50
Grandtour 1.4, 1.6, 2.0 excl. (KM0/1) 09.03 -			RN079A/GL		60			RN080P/GL	$\frac{0}{0}$	50
Grandtour 1.5 dCi, 1.9 dCi excl. (KM0/1) 09.03 -			RN080A/GL		60			RN080P/GL	$\frac{0}{0}$	50
1.6, 2.0, 1.5 dCi, 1.9 dCi (EM0/1) 09.03 -			RN080A/GL		60			RN080P/GL	$\frac{0}{0}$	50

MEGANE III

(BZ0/1, DZ0/1, KZ0/1) 10.08 -			RN094A/GL					RN094P/GL	$\frac{0}{0}$	
-------------------------------	--	--	-----------	--	--	--	--	-----------	---------------	--

MODUS

(F/JPO) 12.04 -			RN082A/GL					RN082P/GL	$\frac{1}{0}$	
-----------------	--	--	-----------	--	--	--	--	-----------	---------------	--

OIL
GAS

OIL
GAS

RENAULT (F)

SAFRANE

excl. 4X4,	(B54)	04.92 - 12.00	 	<i>RN048AS</i> <i>RN048AD</i>	RN048AS/GL RN048AD/GL	 	180		<i>RN048P</i>	RN048P/GL		180
------------	-------	---------------	------	----------------------------------	--------------------------	------	-----	--	---------------	-----------	--	-----

SCÉNIC I

1.4	(JA0/1)	11.96 - 06.98		RN054A	RN054A/GL		100		<i>RN056P</i>	RN056P/GL		35
1.6 excl. Auto.		11.96 - 06.98										
1.6 Auto., 2.0	(JA0/1)	11.96 - 06.98		RN056A	RN056A/GL		100		<i>RN056P</i>	RN056P/GL		35
1.9 D, 1.9 dT, 1.9 dTi		11.96 - 06.98										
excl. RX4	(JA0/1)	06.98 - 06.03		RN054A	RN054A/GL		100		<i>RN056P</i>	RN056P/GL		35
RX4 4X4	(JA0/1)	07.00 - 06.03			RN076A/GL		100			RN076P/GL		35

SCÉNIC II

excl.	(JM0/1)	06.03 -			RN089A/GL					RN089P/GL		
Grand Scénic	(JM0/1)	04.04 -			RN089A/GL					RN090P/GL		

SCÉNIC III

excl. Grand Scénic	(JZ0/1)	02.09 -			RN097A/GL					RN094P/GL		
Grand Scénic	(JZ0/1)	02.09 -			RN097A/GL							

THALIA

1.4, 1.4 16V, 1.6 16V, 1.5dCi		01.01 -			RN068A/GL				<i>RN067P</i>	RN067P/GL		
-------------------------------	--	---------	--	--	-----------	--	--	--	---------------	-----------	--	--

TRAFIC P-SERIES (RWD)

P 3 1000kg		09.80 - 02.89	 	<i>RN103AS</i>			145					75
P 5 Microcar		09.80 - 12.85		<i>RN103AD</i>								
P 6 Microcar		09.80 - 02.89										
P 8 Microcar		09.80 - 12.86										

TRAFIC T-SERIES (FWD)

T 1 800kg excl. → Ch. 25270		09.80 - 02.89	 	<i>RN103AS</i>			145		<i>RN105P</i>			75
T 1, T 4, T 5B		03.89 - 03.01		<i>RN103AD</i>								
T 2		01.86 - 03.01										
T 3 1000kg → Ch. 25270		09.80 - 03.01										
T 4 1000kg excl. → Ch. 25270		09.80 - 02.89										
T 1 800kg		09.80 - 02.89	 	<i>RN103AS</i>			145		<i>RN108P</i>			75
T 4 1000kg		09.80 - 02.89		<i>RN103AD</i>								
T 5		09.80 - 02.89										
T 53, TE		03.89 - 03.01										
T 6 1200kg		01.83 - 12.86										
T 7, TB		01.86 - 03.01										
T 9 1200kg		01.83 - 02.89										
T A 1200kg		09.80 - 12.86	 	<i>RN103AS</i>			145					
T 4 1000kg lifted body Ch. 25271 →		01.83 - 02.89	 	<i>RN103AD</i>					<i>RN105P</i>			75

OIL
GAS

OIL
GAS

RENAULT (F)

TRAFIC II

	(JL, FL)	09.01 -		<i>RN110A</i>	RN110A/GL					RN110P/GL		
--	----------	---------	--	---------------	-----------	--	--	--	--	-----------	--	--

TWINGO

	(C06)	03.93 - 08.00	1 4	<i>RN047A</i>	RN047A/GL		90			RN047P	RN047P/GL		80
	(C06)	09.00 - 08.04	1 2	RN070AS RN070AD	RN070AS/GL RN070AD/GL		100			RN047P/GL		80	
	(CN0)	03.07 -			RN091A/GL		100			RN091P/GL		80	

- 1**
- I** Ammortizzatore senza fissaggio della barra stabilizzatrice.
 - GB** Shock without drop link bracket.
 - F** Amortisseur sans fixation de la barre stabilisatrice.
 - D** Stoßdämpfer ohne Stabilisierungsstangenhalterung.
 - E** Amortiguador sin fijación de barra estabilizadora.
 - P** Amortecedor sem fixação de barra estabilizadora.

- 2**
- I** Ammortizzatore con fissaggio della barra stabilizzatrice.
 - GB** Shock with drop link bracket.
 - F** Amortisseur avec fixation de la barre stabilisatrice.
 - D** Stoßdämpfer mit Stabilisierungsstangenhalterung.
 - E** Amortiguador con fijación de barra estabilizadora.
 - P** Amortecedor com fixação de barra estabilizadora.

- 4**
- I** Vedi disegno/nota Renault Clio a pagina 120
 - GB** See drawing/note Renault Clio on page 120
 - F** Voir plan/note Renault Clio à la page 120
 - D** Siehe Renault Clio Zeichnung/Anmerkung auf Seite 120
 - E** Ver dibujo/anotación Renault Clio a la página 120
 - P** Ver figura/note Renault Clio na página 120

VEL SATIS

	(BJO)	06.02 -			<i>RN087A/GL</i>					<i>RN087P/GL</i>		
--	-------	---------	--	--	------------------	--	--	--	--	------------------	--	--

OIL
GAS

OIL
GAS

ROVER (GB)

25

excl. ZR, Streetwise	(RF)	10.99 - 05.05				RV016A/GL		50				RV009P/GL		50
-----------------------	------	---------------	--	--	--	-----------	--	----	--	--	--	-----------	--	----

45

, 1.4, 1.6, 1.8, 2.0, 2.0 iDT excl. 2.5 ZS	(RT)	02.00 -				HD025AS/GL HD025AD/GL						RV012P/GL		85
--	------	---------	--	--	--	--------------------------	--	--	--	--	--	-----------	--	----

75

	(RJ)	02.99 -				RV015AS/GL RV015AD/GL						RV015P/GL		
--	------	---------	--	--	--	--------------------------	--	--	--	--	--	-----------	--	--

100

	(XP)	11.89 - 12.98			ASPIRA				75					
--	------	---------------	--	--	--------	--	--	--	----	--	--	--	--	--

200

213, 216	(XH)	06.84 - 09.89				HD005A/GL		60				HD005P/GL		50
214, 216	(XW)	10.89 - 10.95				RV005AS/GL		105				HD0021P/GL		85
216 GTi, 220 GTi		10.89 - 10.95				RV005AD/GL								
218 D, 218 TD → Ch. 605481		10.89 - 10.92												
218 D, 218 TD Ch. 605482 →	(XW)	10.92 - 10.95				RV005AS/GL RV005AD/GL		105				HD0021P/GL		85
	(XW)	10.92 - 12.95				RV005AS/GL		105				HD0021P/GL		85
214		10.92 - 12.95				RV005AD/GL								
216	(XW)	10.92 - 12.95				RV005AS/GL RV005AD/GL		105				HD0021P/GL		85
211, 214, 216	(RF)	10.95 - 03.00				RV005AS/GL						RV009P/GL		
220 D, SD, SDi		10.95 - 03.00				RV005AD/GL								
218	(RF)	10.95 - 03.00										RV009P/GL		
200Vi		10.95 - 03.00												

400

414, 416	(XW)	10.89 - 04.95				RV005AS/GL		105				HD0021P/GL		85
418 D → Ch. 605481		10.89 - 10.92				RV005AD/GL								
420 GSi, 420 SLi	(XW)	10.92 - 04.95				RV005AS/GL		105				HD0021P/GL		85
418 D Ch. 605482 →		10.89 - 04.95				RV005AD/GL								
, 414, 416	(RT)	05.95 - 03.00				HD025AS/GL HD025AD/GL						HD0021P/GL		85
, 420, 420 D, 420 Di	(RT)	05.95 - 03.00				HD025AS/GL HD025AD/GL						RV012P/GL		85
Tourer 416 → Ch. 911247	(XW)	10.94 - 02.96				RV005AS/GL RV005AD/GL		105				HD0021P/GL		85
Tourer 418 D → Ch. 911247	(XW)	10.94 - 02.96				RV005AS/GL		105				HD0021P/GL		85
Tourer 420		10.94 - 02.96				RV005AD/GL								
Tourer Ch. 911248 →	(XW)	03.96 - 03.00				RV005AS/GL RV005AD/GL		105				HD0021P/GL		85

OIL
GAS

OIL
GAS

ROVER (GB)

600

excl. 2.0 Turbo, 2.0 D, 2.0 DI → Ch. AM246796	(RH)	04.93 - 02.96			HD014A/GL					HD014P/GL		
excl. 2.0 Turbo, 2.0 D, 2.0 DI Ch. AM246797 →	(RH)	02.96 - 02.99			HD014A/GL					HD014P/GL		
2.0 Turbo, 2.0 D, 2.0 DI	(RH)	02.96 - 02.99										

800

		05.86 - 10.91			<u>RV003A</u> GL		85	1		<u>RV003P</u> GL		120
		11.91 - 02.99			<u>RV014A</u> GL			excl.		<u>RV014P</u> GL		120

- 1**
- Ⓛ Se il veicolo è munito di correttore d'assetto, sostituire la molla con una Rover rif. GSV 1034.
 - ⓄB If the vehicle is equipped with a self levelling suspension, replace the spring by a Rover N° GSV 1034
 - Ⓛ Si le véhicule est équipé d'un correcteur d'assiette, remplacez le ressort par un Rover Réf GSV 1034.
 - Ⓛ Wenn das Fahrzeug mit automatischem Niveau-Ausgleich-System versehen ist, Originalfeder durch Rover Feder Nr. GSV 1034 ersetzen.
 - Ⓛ Si el vehículo está equipado con suspensión autonivelada, sustituya el muelle por un muelle Rover N° GSV 1034.
 - Ⓛ Se o veículo estiver equipado com uma suspensão autonivelável, substitua a mola por uma Rover ref. GSV 1034.

MGF

1.6, 1.8	(RD)	03.95 - 03.02			<u>RV017A</u> GL					<u>RV017P</u> GL		
----------	------	---------------	--	--	------------------	--	--	--	--	------------------	--	--

SD1

2000, 2300, 2600, 3500, 2400 Turbo D excl. Vitesse susp.	(SD1)	06.76 - 12.87			<u>RV002A</u>		160	2		<u>RV002P</u> GL		40
---	-------	---------------	--	--	---------------	--	-----	----------	--	------------------	--	----

- 1**
- Ⓛ Se il veicolo è munito di correttore d'assetto, sostituire la molla con una Rover rif. GSV 1079.
 - ⓄB If the vehicle is equipped with a self levelling suspension, replace the spring by a Rover N° GSV 1079
 - Ⓛ Si le véhicule est équipé d'un correcteur d'assiette, remplacez le ressort par un Rover Réf GSV 1079.
 - Ⓛ Wenn das Fahrzeug mit automatischem Niveau-Ausgleich-System versehen ist, Originalfeder durch Rover Feder Nr. GSV 1079 ersetzen.
 - Ⓛ Si el vehículo está equipado con suspensión autonivelada, sustituya el muelle por un muelle Rover N° GSV 1079.
 - Ⓛ Se o veículo estiver equipado com uma suspensão autonivelável, substitua a mola por uma Rover ref. GSV 1079.

SAAB (S)

90

→ Ch. G6000885		01.60 - 09.84			<u>BE001P</u>	<u>SB003A</u> GL		40		<u>SB002P</u>	<u>SB002P</u> GL		45
Ch. G6000886 →		10.84 - 08.87								<u>SB002P</u>	<u>SB002P</u> GL		

93 / 95 / 96 / 97

93, 93 B		01.56 - 12.59			<u>BE001P</u>	<u>SB003A</u> GL		40			<u>SK001P</u> GL		
95		10.65 - 12.78			<u>BE001P</u>	<u>SB003A</u> GL		40					
96 GT 750, 850, 896 sport Sonett 97 sport		10.65 - 08.80 01.60 - 12.66 01.67 - 12.74			<u>BE001P</u>	<u>SB003A</u> GL		40			SK001A/GL		45

OIL
GAS

OIL
GAS

SAAB (S)

99

, Combi Coupe 1.7, 1.8, 2.0 , 2.0 Turbo, GLE	11.67 - 04.78 10.77 - 04.78		<i>BE001P</i>	<i>SB003A/GL</i>		40		<i>AR003P</i>		50	
, Combi Coupe 2.0, 2.0 Turbo	05.78 - 01.87		<i>BE001P</i>	<i>SB003A/GL</i>		40		<i>SB002P</i>	<i>SB002P/GL</i>		50

9-3

	(YS3D)	02.98 - 09.02 02.98 - 08.03			<i>SB012A/GL</i>		100			<i>SB005P/GL</i>		40
excl.	(YS3F)	09.02 -			<i>SB0010AS/GL</i>		60			<i>SB010P/GL</i>		40
excl.	(YS3F)	08.03 -			<i>SB0010AD/GL</i>							

9-5

2.0, 2.3, 3.0 V6 Aero 2.3 Turbo	(YS3E)	09.97 - 09.01 09.97 - 09.01	 		<i>SB008AS/GL</i> <i>SB008AD/GL</i>	 	80			<i>SB008P/GL</i>		60
2.0, 2.3, 3.0 V6 Aero 2.3 Turbo	(YS3E)	10.98 - 09.01 10.98 - 09.01	 		<i>SB008AS/GL</i> <i>SB008AD/GL</i>	 	80			<i>SB008P/GL</i>		60
excl.		09.01 -	 		<i>SB0011AS/GL</i> <i>SB0011AD/GL</i>	 	80			<i>SB008P/GL</i>		60

900 I

, Combi Coupe, C, GL, GLS, GLi		06.78 - 12.93		<i>SB002A</i>	<i>SB002A/GL</i>		40		<i>SB002P</i>	<i>SB002P/GL</i>		50
, Combi Coupe, EMS, GLE, Turbo, Turbo 16, CD		06.78 - 12.93			<i>SB002A/GL</i>		40			<i>SB002P/GL</i>		50
, Combi Coupe, Turbo 16, Turbo 16 Aero excl. 16 S sport		01.84 - 12.93			<i>SB002A/GL</i>		40			<i>SB002P/GL</i>		50
, Combi Coupe, Turbo 16, Turbo 16 Aero excl. 16 S sport		01.84 - 12.93								<i>SB002P/GL</i>		50

1	Sospensione anteriore senza barra di torsione.	Vorderaufhängung ohne Torsionsstab.
	Front suspension without torsion bar.	Suspensión delantera sin barra de torsión.
	Train avant sans barre de torsion.	Suspensão dianteira sem barra estabilizadora.

900 II

		07.93 - 02.98			<i>SB013A/GL</i>					<i>SB005P/GL</i>		
--	--	---------------	--	--	------------------	--	--	--	--	------------------	--	--

9000

 → Ch. H 1015469 → Ch. H 8000555		09.84 - 12.87			<i>SB001A/GL</i>		100	excl.		<i>SB001P/GL</i>		90
 Ch. H 1015470 → Ch. H 8000556 →		01.87 - 12.98			<i>SB007A/GL</i>		100	excl.		<i>SB001P/GL</i>		90

OIL
GAS

OIL
GAS

SEAT (E)

124

Sport, Pamplona	1967 -		FI016A					FI022P			
Familiar	01.70 - 12.76		FI016A					FI019P			

127 / FURA

excl. Crono (127A, 025A)	04.72 - 12.82		FI012A			50		FI012P			70
Crono	01.82 -							FI012P			70

128

	01.69 - 12.80		FI013A			70		FI013P			70
--	---------------	--	--------	--	--	----	--	--------	--	--	----

131

excl. Diesel	12.78	1	FI022A			80		FI022P			70
excl. Diesel	01.78 - 09.81	2	FI042A			80		FI022P			70
excl. Diesel	10.81 -	3	FI053A			80		FI022P			70
Diesel	12.78	4	FI023A			80		FI022P			70
Diesel	01.79 - 09.81	5	FI055A			80		FI022P			70
excl. Diesel	12.78	1	FI022A			80		FI032P			40
excl. Diesel	01.79 - 09.81	2	FI042A			80		FI032P			40
excl. Diesel	10.81 -	3	FI053A			80		FI032P			40
Diesel	01.79 - 09.81	5	FI055A			80		FI032P			40

1 2 3 4 5
1 Vedi disegno/nota Fiat 131 a pagina 37

2 See drawing/note Fiat 131 on page 37

3 Voir plan/note Fiat 131 à la page 37

D Siehe Fiat 131 Zeichnung/Anmerkung auf Seite 37

E Ver dibujo/anotación Fiat 131 a la página 37

P Ver figura/note Fiat 131 na página 37

132

	01.73 - 12.82		FI021A			70		FI021P			70
--	---------------	--	--------	--	--	----	--	--------	--	--	----

ALHAMBRA

(7V8, 7V9)	04.96 - 03.10		FR054A	FR054A/GL		70		FR054P	FR054P/GL		40
(710)	06.10 -			VW036A/GL					VW036P/GL		

ALTEA/ALTEA XL

excl. 4X4 (5P)	04.04 -	6		VW036A/GL					VW036P/GL		
		7		AU038A/GL							
4X4, excl. 4X4 (5P)	04.04 -	6		VW037A/GL					VW037P/GL		
		7		AU039A/GL							

6 7
1 Vedi disegno/nota Seat Toledo a pagina 133

2 See drawing/note Seat Toledo on page 133

3 Voir plan/note Seat Toledo à la page 133

D Siehe Seat Toledo Zeichnung/Anmerkung auf Seite 133

E Ver dibujo/anotación Seat Toledo a la página 133

P Ver figura/note Seat Toledo na página 133

OIL
GAS

OIL
GAS

SEAT (E)

AROSA

	(6H)	05.97 - 06.04	ACC19 5	VW029A	VW029A/GL		120		VW033P	VW033P/GL		60
--	------	---------------	------------	--------	-----------	--	-----	--	--------	-----------	--	----

CORDOBA I

excl. 1.8 16V, 2.0 GTI → Ch. 6K#TR80000	(6K2, C2)	02.93 - 12.95	ACC64 5	VW021A	VW021A/GL		120		SE012P	SE012P/GL		60
excl. 1.8 16V, 2.0 GTI Ch. TR80001 → 6K#X#400.000	(6K2, C2)	01.96 - 08.99	ACC64 5	VW021A	VW021A/GL		120		SE012P	SE012P/GL		60
1.8 16V, 2.0 GTI → Ch. 6K-ZR082400 → Ch. 6K-ZR599964	(6K2, C2)	10.93 - 08.99	ACC64 5		VW021A/GL		120		SE013P	SE013P/GL		60
1.8 16V, 2.0 GTI Ch. 6K-ZR082401 → Ch. 6K-ZR599965 →	(6K2, C2)	10.93 - 08.99	ACC51 5		VW028A/GL		120		SE013P	SE013P/GL		60

CORDOBA II

excl. 1.8 20V Turbo Ch. 6K#X#400.001 →	(6K2)	03.99 - 10.02	ACC51 5		VW028A/GL		120		VW032P	VW032P/GL		60
1.8 20V Turbo	(6K2)	03.99 - 10.02	5		VW028A/GL					VW032P/GL		

CORDOBA VARIO

Vario	(6K5)	08.96 - 08.02	ACC64 5	VW021A	VW021A/GL		120		VW032P	VW032P/GL		60
-------	-------	---------------	------------	--------	-----------	--	-----	--	--------	-----------	--	----

CORDOBA III

excl. 1.8 20V Turbo excl.	(6L2)	10.02 - 11.09	N.D. H.D. 5	VW035A AUC031A	VW035A/GL AUC031A/GL		110		<u>SD003P</u>	SD003P/GL		60
excl. 1.8 20V Turbo 	(6L2)	10.02 - 11.09	5	AUC031A	AUC031A/GL		110		<u>SD004P</u>	SD004P/GL		60

EXEO

excl.	(3R2)	12.08 -			AU041A/GL					AU041P/GL		
excl.	(3R5)	06.09 -			AU041A/GL					AU041P/GL		

IBIZA I

→ Ch. 9146536	(021A)	06.84 - 05.86	ACC50	SE004A			100		FI028P	<u>FI028P/GL</u>		70
Ch. 9146537 →	(021A)	06.86 - 08.89	ACC50	SE005A	<u>SE005A/GL</u>		100		FI028P	<u>FI028P/GL</u>		70
	(021A)	09.89 - 12.93	ACC50	SE009A	<u>SE009A/GL</u>		100		FI028P	<u>FI028P/GL</u>		70

IBIZA II

excl. 1.8 16V, 2.0 GTI → Ch. 6K#TR80000	(6K1)	02.93 - 12.95	ACC64 5	VW021A	VW021A/GL		120		SE012P	SE012P/GL		60
excl. 1.8 16V, 2.0 GTI Ch. TR80001 → 6K#X#400.000	(6K1)	01.96 - 08.99	ACC64 5	VW021A	VW021A/GL		120		SE012P	SE012P/GL		60
1.8 16V, 2.0 GTI → Ch. 6K-ZR082400 → Ch. 6K-ZR599964	(6K1)	10.93 - 03.99	ACC64 5		VW021A/GL		120		SE013P	SE013P/GL		60

OIL
GAS

OIL
GAS

SEAT (E)

IBIZA II

1.8 16V, 2.0 GTI Ch. 6K-ZR082401 → Ch. 6K-ZR599965 →	(6K1)	10.93 - 03.99	ACC51 5	VW028A/GL		120		SE013P	SE013P/GL		60
--	-------	---------------	------------	-----------	--	-----	--	--------	-----------	--	----

IBIZA III

excl. 1.8 20V Turbo Ch. 6K#X#400.001 →	(6K1)	03.99 - 02.02	ACC51 5	VW028A/GL		120		VW032P	VW032P/GL		60
1.8 20V Turbo	(6K2)	03.99 - 10.02	5	VW028A/GL				VW032P/GL			

IBIZA IV

excl. 1.8 20V Turbo excl.	(6L1)	02.02 - 11.09	N.D. H.D. 3	VW035A AUC031A	VW035A/GL AUC031A/GL		110		<u>SD003P</u>	SD003P/GL		60
excl. 1.8 20V Turbo 	(6L1)	02.02 - 11.09	3	AUC031A	AUC031A/GL		110		<u>SD004P</u>	SD004P/GL		60

IBIZA V

	(6J5)	03.08 -			SE016A/GL					SD016P/GL		
	(6J8)	03.10 -			SE016A/GL					SD016P/GL		
	(6J1)	07.08 -			SE016A/GL					SD016P/GL		

INCA

	(6K9)	11.95 - 06.09	5	VW029A	VW029A/GL		70		SE014P	SE014P/GL		30
--	-------	---------------	---	--------	-----------	--	----	--	--------	-----------	--	----

- | | |
|--|--|
| <p>3 Vedi disegno/nota Volkswagen Polo a pagina 162</p> <p> See drawing/note Volkswagen Polo on page 162</p> <p> Voir plan/note Volkswagen Polo à la page 162</p> <p> Siehe Volkswagen Polo Zeichnung/Anmerkung auf Seite 162</p> <p> Ver dibujo/anotación Volkswagen Polo a la página 162</p> <p> Ver figura/nota Volkswagen Polo na página 162</p> | <p>5 Vedi disegno/nota Volkswagen Golf a pagina 157</p> <p> See drawing/note Volkswagen Golf on page 157</p> <p> Voir plan/note Volkswagen Golf à la page 157</p> <p> Siehe Volkswagen Golf Zeichnung/Anmerkung auf Seite 157</p> <p> Ver dibujo/anotación Volkswagen Golf a la página 157</p> <p> Ver figura/nota Volkswagen Golf na página 157</p> |
|--|--|

LEON I

1.4 16V, 1.6, 1.6 16V, 1.9 SDI excl. ,	(1M1)	10.98 - 06.06	4	VW034A	VW034A/GL		90			AU028P/GL		50
1.8, 2.3, 1.9 TDI excl. 1.8 Turbo, ,	(1M1)	10.98 - 06.06	4	AU018A	AU018A/GL		90			AU028P/GL		50

- | |
|--|
| <p>4 Vedi disegno/nota Volkswagen Golf a pagina 158</p> <p> See drawing/note Volkswagen Golf on page 158</p> <p> Voir plan/note Volkswagen Golf à la page 158</p> <p> Siehe Volkswagen Golf Zeichnung/Anmerkung auf Seite 158</p> <p> Ver dibujo/anotación Volkswagen Golf a la página 158</p> <p> Ver figura/nota Volkswagen Golf na página 158</p> |
|--|

OIL
GAS

OIL
GAS

SEAT (E)

LEON II

excl.	(1P1)	09.05 -	6		VW036A/GL					VW036P/GL	$\frac{1}{0}$	
	(1P1)	09.05 -	7		AUC38A/GL							
	(1P1)	09.05 -	6		VW037A/GL					VW037P/GL	$\frac{1}{0}$	
			7		AUC39A/GL							

LEON III

excl. Cupra,	(5F1)	09.12 -	6		<u>VW046A/GL</u>		140			<u>VW045P/GL</u>	$\frac{1}{0}$	70
			7		<u>VW045A/GL</u>		140					

MALAGA / CREDOS

→ Ch. 9071599		11.84 - 08.86	ACC50	SE004A			100		FI028P			70
Ch. 9071600 →	(023A)	09.86 - 08.89	ACC50	SE005A	<u>SE005A/GL</u>		100		FI028P	<u>FI028P/GL</u>		70
		09.89 - 12.93	ACC50	SE009A	<u>SE009A/GL</u>		100		FI028P	<u>FI028P/GL</u>		70

MARBELLA

	(28, 28A)	08.86 - 03.89	ACC45	FI048A	FI048A/GL		70		FI037P		$\frac{0}{0}$	30
		04.89 - 10.98	ACC45	SE007A			70		FI037P		$\frac{0}{0}$	30

PANDA

	(141A)	10.80 - 12.86	ACC45	FI048A	FI048A/GL		70		FI037P		$\frac{0}{0}$	30
--	--------	---------------	-------	--------	-----------	--	----	--	--------	--	---------------	----

RONDA / RITMO

	(022A, 138)	07.78 - 09.83	ACC21	FI028A	FI028A/GL		100		FI028P	<u>FI028P/GL</u>		70
excl. Crono	(022A, 138)	10.83 - 03.86	ACC50	SE004A			100		FI028P	<u>FI028P/GL</u>		70
excl. Crono	(022A, 138)	05.86 - 11.88	ACC50	SE005A	<u>SE005A/GL</u>		100		FI028P	<u>FI028P/GL</u>		70
Crono	(022A, 138)	10.83 - 03.86	ACC50	SE004A			100		FI028P	<u>FI028P/GL</u>		70

TERRA

	(024, 024A)	01.87 - 03.89		FI048A	FI048A/GL		70		FI037P		$\frac{0}{0}$	30
	(024, 024A)	04.89 - 12.96		SE007A			70		FI037P		$\frac{0}{0}$	30

TOLEDO I

1.6, 1.9 D, 1.9 TD, 1.9 TDI	(1L)	01.91 - 12.92	ACC64	VW021A	VW021A/GL		60	ACC68	VW016P	VW016P/GL		50
	(1L)	01.93 - 10.99	5					ACC68	VW016P	VW016P/GL		50
1.6, 1.9 D, 1.9 TD, 1.9 TDI	(1L)	01.93 - 10.99	ACC64	VW021A	VW021A/GL		60	ACC68	VW016P	VW016P/GL		50
	(1L)	01.91 - 12.92	ACC64		<u>VW018A/GL</u>		60	ACC68	VW016P/GL		50	
	(1L)	01.93 - 10.99	ACC64		<u>VW018A/GL</u>		60	ACC68	VW016P/GL		50	

TOLEDO II

1.4 16V, 1.6, 1.6 16V 1.9 SDI Excl. ,	(1M2)	04.99 - 05.06	4	VW034A	VW034A/GL		100		<u>AU018P</u>	AU018P/GL	$\frac{1}{0}$	40
1.8, 2.3 V5, 1.9 TDI Excl. 1.8 Turbo, ,	(1M2)	04.99 - 05.06	4	AU018A	AU018A/GL		100			AU018P/GL	$\frac{1}{0}$	40

OIL
GAS

OIL
GAS



SEAT (E)

TOLEDO III

excl.	(5P2)	04.04 - 05.09	6		VW036A/GL					VW036P/GL	$\frac{1}{0}$	
			7		AU038A/GL							
	(5P2)	04.04 - 05.09	6		VW037A/GL					VW037P/GL	$\frac{1}{0}$	
			7		AU039A/GL							

TOLEDO IV

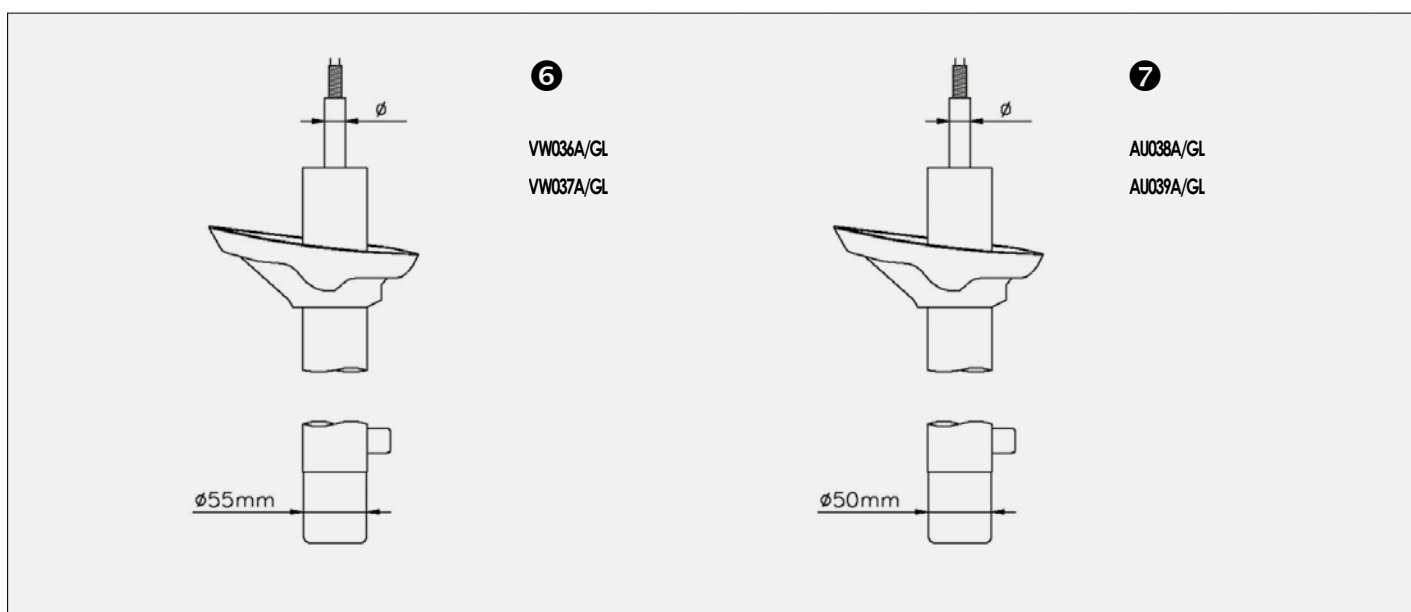
	(KG3)	07.12 -			SE016A/GL					SD016P/GL	$\frac{1}{0}$	
--	-------	---------	--	--	-----------	--	--	--	--	-----------	---------------	--



4	I Vedi disegno/nota Volkswagen Golf a pagina 158	5	I Vedi disegno/nota Volkswagen Golf a pagina 157
	GB See drawing/note Volkswagen Golf on page 158		GB See drawing/note Volkswagen Golf on page 157
	F Voir plan/note Volkswagen Golf à la page 158		F Voir plan/note Volkswagen Golf à la page 157
	D Siehe Volkswagen Golf Zeichnung/Anmerkung auf Seite 158		D Siehe Volkswagen Golf Zeichnung/Anmerkung auf Seite 157
	E Ver dibujo/anotación Volkswagen Golf a la página 158		E Ver dibujo/anotación Volkswagen Golf a la página 157
	P Ver figura/nota Volkswagen Golf na página 158		P Ver figura/nota Volkswagen Golf na página 157

TRANS

		01.85 - 12.96			FI048A	FI048A/GL		70		FI037P	$\frac{0}{0}$	30
--	--	---------------	--	--	--------	-----------	--	----	--	--------	---------------	----

SKODA (CS)

100 SERIES

100, 105, 110, 120	(742, 744)	01.70 - 12.90						$\frac{1}{0}$	30		<i>SD007P</i>		$\frac{1}{1}$	45
130, 130, Rapid		04.81 - 10.91						$\frac{1}{0}$	30					
135		11.88 -						$\frac{1}{0}$	30		<i>SD007P</i>		$\frac{1}{1}$	45

1000 SERIES

excl.		09.64 - 01.70						$\frac{1}{0}$			<i>SD007P</i>		$\frac{1}{1}$	
Octavia		01.67 - 01.70						$\frac{1}{0}$						

OIL
GAS

OIL
GAS

SKODA (CS)

FABIA

1.0, 1.4, 1.4 16V, 2.0, 1.9 SDI excl.	(6Y2, 6Y3, 6Y5)	12.99 - 03.08	3	SDC03A	SDC03A/GL		90		<u>SDC03P</u>	SDC03P/GL		50
1.4 TDI, 1.9 TDI excl.	(6Y2, 6Y3, 6Y5)	12.99 - 03.08	3	VW035A	VW035A/GL		90		<u>SDC04P</u>	SDC04P/GL		50
		12.06 -	3		VW035A/GL		90			SDC03P/GL		50
Combi		10.07 -	3		VW035A/GL		90			SDC04P/GL		50

- 3** **I** Vedi disegno/nota Volkswagen Polo a pagina 162 **D** Siehe Volkswagen Polo Zeichnung/Anmerkung auf Seite 162
GB See drawing/note Volkswagen Polo on page 162 **E** Ver dibujo/anotación Volkswagen Polo a la página 162
F Voir plan/note Volkswagen Polo à la page 162 **P** Ver figura/nota Volkswagen Polo na página 162

FAVORIT

excl.	(781)	05.89 - 09.94		SDC01A			75		SDC01P			60
-------	-------	---------------	--	--------	--	--	----	--	--------	--	--	----

FELICIA

, , excl. ABS	(6U1, 6U5, 797)	10.94 - 06.01		SDC02A					SDC01P			60
, , ABS	(6U1, 6U5, 797)	10.94 - 06.01		SDC02A			60		SDC01P			60

FORMAN

	(785)	08.91 - 10.94		SDC01A			75		SDC01P			60
--	-------	---------------	--	--------	--	--	----	--	--------	--	--	----

OCTAVIA

1.4, 1.6, 1.9 SDI, 1.9 TDI excl. 4X4	(1U2)	10.96 - 12.10	4	VW034A	VW034A/GL		120		<u>AU018P</u>	AU018P/GL		60
1.8, 2.0, 1.8 Turbo excl. RS 1.8 Turbo, 4X4	(1U2)	10.96 - 12.10	4	AU018A	AU018A/GL		120		<u>AU018P</u>	AU018P/GL		60
4X2 excl. RS 1.8 Turbo	(1U5)	07.98 - 12.10	4	VW034A	VW034A/GL		120		<u>AU018P</u>	AU018P/GL		60
4X4	(1U5)	07.98 - 12.10	4	VW034A	VW034A/GL		120			SDC03P/GL		60
, excl.	(1Z3, 1Z5)	06.04 -	6 7		VW036A/GL AU038A/GL					VW036P/GL		
	(1Z3)	06.04 -	6 7		VW037A/GL AU039A/GL					VW037P/GL		
Assale rigido excl. RS	(5E3, 5E5)	11.12 -	6 7		VW046A/GL VW045A/GL					VW045P/GL		
Assale Multilink excl. RS	(5E3, 5E5)	11.12 -	6 7		VW046A/GL VW045A/GL					VW046P/GL		

- 6 7** **I** Vedi disegno/nota Seat Toledo a pagina 133 **4** **I** Vedi disegno/nota Volkswagen Golf a pagina 158
GB See drawing/note Seat Toledo on page 133 **GB** See drawing/note Volkswagen Golf on page 158
F Voir plan/note Seat Toledo à la page 133 **F** Voir plan/note Volkswagen Golf à la page 158
D Siehe Seat Toledo Zeichnung/Anmerkung auf Seite 133 **D** Siehe Volkswagen Golf Zeichnung/Anmerkung auf Seite 158
E Ver dibujo/anotación Seat Toledo a la página 133 **E** Ver dibujo/anotación Volkswagen Golf a la página 158
P Ver figura/nota Seat Toledo na página 133 **P** Ver figura/nota Volkswagen Golf na página 158

OIL
GAS

OIL
GAS

SKODA (CS)

RAPID

	02.83 - 10.91				$\frac{1}{5}$	30				$\frac{1}{5}$	
--	---------------	--	--	--	---------------	----	--	--	--	---------------	--

RAPID II

	07.12 -			SE016A/GL					SD016P/GL	$\frac{1}{5}$	
Spaceback	10.13 -			SE016A/GL					SD016P/GL	$\frac{1}{5}$	

ROOMSTER

incl. Praktik	(5J) 05.06 -			VW035A/GL		90			AU028P/GL	$\frac{1}{5}$	50
---------------	--------------	--	--	-----------	--	----	--	--	-----------	---------------	----

SUPERB

excl.	(3U4) 02.02 - 03.08			AU044A/GL	$\frac{1}{5}$	110			AU023P/GL	$\frac{1}{5}$	50
	(3T4) 03.08 -			VW036A/GL					VW036P/GL	$\frac{1}{5}$	
	(3T5) 10.09 -			VW037A/GL					VW037P/GL	$\frac{1}{5}$	

YETI

	(5L) 05.09 -			AU038A/GL					SD008P/GL	$\frac{1}{5}$	
--	--------------	--	--	-----------	--	--	--	--	-----------	---------------	--

SMART (D)

CABRIO

	03.00 - 01.04			SR001A/GL	$\frac{1}{5}$				SR001P/GL	$\frac{1}{5}$	
	03.00 - 01.04			SR002A/GL					SR001P/GL	$\frac{1}{5}$	

CITY-COUPÉ

(Ch. XH, YH)	(MC01) 07.98 - 01.04			SR001A/GL	$\frac{1}{5}$	50			SR001P/GL	$\frac{1}{5}$	60
(Ch. 1H)	(MC01) 07.98 - 01.04			SR002A/GL					SR001P/GL	$\frac{1}{5}$	60

CROSSBLADE

	06.02 -			SR001A/GL	$\frac{1}{5}$				SR001P/GL	$\frac{1}{5}$	
	06.02 -			SR002A/GL					SR001P/GL	$\frac{1}{5}$	

FORFOUR

	04.04 -			SR004AS/GL					SR004P/GL	$\frac{1}{5}$	
				SR004AD/GL							

FORTWO

	01.04 - 12.06			SR001A/GL	$\frac{1}{5}$				SR001P/GL	$\frac{1}{5}$	
	01.04 - 12.06			SR002A/GL					SR001P/GL	$\frac{1}{5}$	
	01.07 -			SR005A/GL					SR005P/GL	$\frac{1}{5}$	

ROADSTER

	04.03 -			SR001A/GL	$\frac{1}{5}$				SR001P/GL	$\frac{1}{5}$	
	04.03 -			SR002A/GL					SR001P/GL	$\frac{1}{5}$	

OIL
GAS

OIL
GAS

SSANG YONG (KO)

KORANDO

	(KJ)	12.96 -			SY003A/GL	$\frac{1}{6}$	30			SY003P/GL	$\frac{1}{6}$	
--	------	---------	--	--	-----------	---------------	----	--	--	-----------	---------------	--

MUSSO

	(FJ)	10.95 -			SY002A/GL	$\frac{1}{6}$	60			SY002P/GL	$\frac{1}{6}$	60
--	------	---------	--	--	-----------	---------------	----	--	--	-----------	---------------	----

REXTON

	(GAB)	04.02 - 08.06			SY001A/GL					SY001P/GL	$\frac{1}{6}$	
	(GAB)	01.07 -			SY004A/GL					SY004P/GL	$\frac{1}{6}$	

SUBARU (J)

FORESTER

2.0 4WD excl. Turbo,	(SF5)	08.97 - 09.02			<u>SY006ASGL</u>					<u>SY006PSGL</u>		
					<u>SY006ADGL</u>					<u>SY006PDGL</u>		
2.0, 2.0 Turbo 4WD, excl.	(SG5)	09.02 - 01.03			<u>SY014ASGL</u>					<u>SY014PSGL</u>		
					<u>SY014ADGL</u>					<u>SY014PDGL</u>		
2.0, 2.0 Turbo 4WD, excl.	(SG5)	01.03 -			<u>SY015ASGL</u>					<u>SY014PSGL</u>		
2.5 excl.	(SG5)	09.04			<u>SY015ADGL</u>					<u>SY014PDGL</u>		

IMPREZA

1.6, 1.8, 2.0 2WD	(GC, GF 3/5/7)	08.92 - 12.00			<u>SY001ASGL</u>					<u>SY001PSGL</u>		
					<u>SY001ADGL</u>					<u>SY001PDGL</u>		
1.6, 1.8, 2.0 4WD excl. 2.0 GT Turbo	(GC, GF 4/6/8)	08.92 - 12.00			<u>SY001ASGL</u>					<u>SY002PSGL</u>		
					<u>SY001ADGL</u>					<u>SY002PDGL</u>		
2.0 GT Turbo 4WD	(GC, GF 8_18)	08.92 - 12.00			<u>SY003ASGL</u>					<u>SY002PSGL</u>		
					<u>SY003ADGL</u>					<u>SY002PDGL</u>		
2.0, 2.0 Turbo WRX excl. WRX-STi	(GD)	10.00 - 10.02			<u>SY016ASGL</u>					<u>SY017PSGL</u>		
					<u>SY016ADGL</u>					<u>SY017PDGL</u>		
2.0, 2.0 Turbo WRX excl. WRX-STi	(GD)	11.02 - 12.02			<u>SY016ASGL</u>					<u>SY016PSGL</u>		
					<u>SY016ADGL</u>					<u>SY016PDGL</u>		
2.0, 2.0 Turbo WRX excl. WRX-STi	(GD)	01.03 -			<u>SY017ASGL</u>					<u>SY017PSGL</u>		
					<u>SY017ADGL</u>					<u>SY017PDGL</u>		
1.6, 2.0, 2.0 Turbo WRX	(GG)	10.00 - 10.02			<u>SY018ASGL</u>					<u>SY018PSGL</u>		
					<u>SY018ADGL</u>					<u>SY018PDGL</u>		
1.6, 2.0, 2.0 Turbo WRX excl. WRX-STi	(GG)	11.02 - 12.02			<u>SY018ASGL</u>					<u>SY019PSGL</u>		
					<u>SY018ADGL</u>					<u>SY019PDGL</u>		
1.6, 2.0, 2.0 Turbo WRX excl. WRX-STi	(GG)	01.03 -			<u>SY019ASGL</u>					<u>SY019PSGL</u>		
					<u>SY019ADGL</u>					<u>SY019PDGL</u>		

JUSTY

1.3	(HSJ56, HSN56)	10.95 - 08.03			<u>SY005A/GL</u>					<u>SY005P/GL</u>		
	(GX3)	09.03 -			<u>SK012AS/GL</u>					<u>OG052P/GL</u>	$\frac{0}{0}$	
					<u>SK012AD/GL</u>							

OIL
GAS

OIL
GAS

SUBARU (J)

LEGACY

4X2	(BC, BF, BJ)	01.89 - 12.91			SU007ASGL					SU007PSGL		
					SU007ADGL					SU007PDGL		
4X2	(BC, BF, BJ)	01.92 - 08.94			SU011ASGL					SU011PSGL		
					SU011ADGL					SU011PDGL		
4X4	(BC, BF, BJ)	01.89 - 12.91			SU007ASGL					SU009PSGL		
					SU007ADGL					SU009PDGL		
4X4 excl. 2.0 Turbo	(BC, BF, BJ)	01.92 - 08.94			SU011ASGL					SU012PSGL		
					SU011ADGL					SU012PDGL		
2.0 Turbo 4X4	(BC, BF 5_L8)	01.92 - 08.94			SU012ASGL					SU012PSGL		
					SU012ADGL					SU012PDGL		
4X2	(BD, BG)	01.94 - 1999			SU001ASGL					SU008PSGL		
					SU001ADGL					SU008PDGL		
2.0, 2.2 4X4	(BD, BG 5/7)	01.94 - 1999			SU001ASGL					SU010PSGL		
					SU001ADGL					SU010PDGL		
2.5 4X4 excl. Outback	(BD, BG 9_L9)	06.96 - 1999			SU012ASGL					SU020PSGL		
					SU012ADGL					SU020PDGL		
2.5 Outback 4X4	(BG9_LB)	06.96 - 1999			SU021ASGL					SU021PSGL		
					SU021ADGL					SU021PDGL		
2.0, 2.5 4X4 excl. , , Outback	(BE, BH)	12.98 - 09.03			SU022ASGL					SU022PGL		
					SU022ADGL							
2.5 Outback 4X4 excl. ,	(BE, BH)	12.98 - 09.03			SU023ASGL					SU023PGL		
					SU023ADGL							
2.0i, 2.5i, 3.0R 4X4 excl. 3.0R Spec B, Outback	(BL)	09.03 -			SU024ASGL					SU024PGL		
					SU024ADGL							
2.0i, 2.5i, 3.0R Outback 4X4 excl.	(BP)	09.03 -			SU025ASGL					SU025PGL		
					SU025ADGL							

LEONE II / LOYALE / L

4X2	(AC)	09.84 - 09.91			SU028ASGL		40			SU028PGL		25
					SU028ADGL		40					25
4X2	(AG)	09.84 - 12.89			SU028ASGL		40			SU028PGL		25
					SU028ADGL		40					25
4X2	(AN)	09.84 - 12.93			SU028ASGL		40			SU029PGL		
					SU028ADGL		40					
, , excl.	(AC, AG, AN)	09.84 - 12.86			SU029ASGL							
excl. 1.8 Turbo,		01.87 - 12.93			SU029ADGL							
4X4												
1.8 Turbo excl.	(AC, AG, AN)	01.87 - 12.89			SU029ASGL					SU029PGL		
, excl.		01.87 - 12.93			SU029ADGL							
4X4												

OIL
GAS

OIL
GAS

SUZUKI (J)

ALTO I / FRONTE

	(SS80)	1981 - 12.85							<i>BE003P</i>		50
--	--------	--------------	--	--	--	--	--	--	---------------	--	----

ALTO II / FRONTE

(SB308)	(CA91, CB91)	12.85 - 12.87			SK015A		220		<i>SK015P</i>		50
(SB308)	(CA91, CB91)	01.88 - 12.90			SK015A		220		<i>SK016P</i>		50
(SB308)	(EC)	01.91 - 02.94			SK015A		220		<i>SK016P</i>		50

ALTO III / FRONTE

(SH410)	(FA11, FB11)	10.94 - 06.02			SK017AS/GL SK017AD/GL		100			SK017P/GL		50
---------	--------------	---------------	--	--	--------------------------	--	-----	--	--	-----------	--	----

ALTO IV / FRONTE

(RF410)	(FF)	06.02 -								SK019P/GL		
---------	------	---------	--	--	--	--	--	--	--	-----------	--	--

BALENO

, , 1.3 (SY413)	(EG)	07.95 -			<i>SK007AS</i>		70		<i>SK007PS</i>		90
, , 1.5 (SY415)	(EG)	07.95 -			<i>SK007AD</i>				<i>SK007PD</i>		
, , 1.6 (SY416)	(EG)	07.95 -									
, , 1.6 4WD (SY416)	(EG)	07.95 -									
, , 1.8 (SY418)	(EG)	07.95 -									
, , 1.9 TD	(EG)	07.95 -									
excl.											

CARRY

	(ST90V)	11.80 - 10.85							<i>BE003P</i>		50
excl. ,	(SK 408/410)	01.86 -							<i>BE003P</i>		50
,	(SK 408/410)	01.86 -							<i>BE004P</i>		

GRAND VITARA

1.6 3(△)	(SQ416 - TA0)	03.98 -			SK010AS/GL		140			SK002P/GL		70
2.0 3(△)	(SQ420 - TA5)	03.98 -			SK010AD/GL							
2.0 5(△)	(SQ420 - TL5)	03.98 -										
2.0 TD 5(△)	(SQ420 - TD3)	03.98 -										
2.5 5(△)	(SQ420 - TD6)	03.98 -										
1.6 3(△)	(XL6, XL7)	01.06 -			SK011AS/GL		140			SK011P/GL		70
1.9 DDIS 3(△)	(XL6, XL7)	01.06 -			SK011AD/GL							
1.9 DDIS 5(△)	(XL6, XL7)	01.06 -										
2.0 L 5(△)	(XL6, XL7))	01.06 -										

IGNIS

1.3 2WD	(FH)	10.00 - 09.03			<i>SK009AS/GL</i>					SK014P/GL		
1.3 4WD	(FH)	10.00 - 09.03			<i>SK009AD/GL</i>					SK009P/GL		

OIL
GAS

OIL
GAS

SUZUKI (J)

IGNIS

1.3 2WD excl. 1.3 DDIS (MH)	09.03 -			SK012AS/GL					OG052P/GL		
1.5 2WD/4WD				SK012AD/GL							
1.3 DDIS (MH)	09.03 -			SK013AS/GL					OG052P/GL		
				SK013AD/GL							

JIMNY

LJ 10, LJ 20	01.70 - 06.77			SK001A	SK001A/GL				DA002A	SK001P/GL		
SJ 10, LJ 81	01.70 - 06.77											
LJ 80, LJ 80 Q, LJ 80 V	06.77 - 12.81			SK001A	SK001A/GL							
LJ 81 K, LJ 81 P	06.77 - 12.81											
SJ 410, SJ 413	01.81 - 12.87			SK001A	SK001A/GL				DA002A	SK001P/GL		50
SJ 413-4 Samurai	01.87 -			SK001A	SK001A/GL				SK001P	SK001P/GL		50
									DA002A			
SJ 419 Samurai	09.98 -						90					60
(SN 413)	(FJ) 09.98 -				SK018A/GL		90			SK018P/GL		60

MARUTI

				SK004AS					SK004P			20
				SK004AD								

SPLASH

	01.08 -			SK020AS/GL					SK020P/GL		
				SK020AD/GL							

SWIFT I

1.0, 1.3 (SA 310, 413) (AA41, AA51)	10.83 - 12.85						110					50
1.0, 1.3, 1.3 GTi/GXi (SA 310-3, 413-3) (AA43, AA53, AA33)	01.86 - 12.89						110					50

SWIFT II

1.0 (SF310) (AA/AB 44)	03.89 - 1992			SK003A/GL			110			SK003P/GL		100
1.3 (SF413) (AA/AB 35)	03.89 - 1992											
excl. GTi, 4WD												
1.3 GTi (SF413) → Ch. S00104275 (AA 34)	03.89 - 12.89			SK003A/GL			110			SK003P/GL		100
1.3 4WD (SF413) → Ch. S00102077 (AF 35)	03.89 - 12.90			SK008A/GL			110			SK003P/GL		100
1.3 GTi (SF413) Ch. S00104276 → S0014000 (AA 34)	01.90 - 1992			SK008A/GL			110			SK003P/GL		100
1.0 (SF310) (AA/AB 44)	1992 - 11.96			SK008A/GL			110			SK003P/GL		100
1.3 (SF413) (AA/AB 35)	1992 - 11.96											
1.3 GTi (SF413) Ch. S00140001 → (AA 34)	1992 - 11.96											
1.3 4WD (SF413) → Ch. S00102077 (AF 35)	01.91 - 11.96											
1.3 (SF413) → Ch. 00107571 (AH 35)	03.89 - 1990			SK008A/GL			110			SK003P/GL		100
1.6 2WD (SF416) → Ch. 00109591 (AH 14)	03.89 - 1990											
1.6 4WD (SF416) → Ch. 00102383 (AJ 14)	03.89 - 1990											
1.3 (SF413) Ch. 00107572 → (AH 35)	1990 - 11.96			SK008A/GL			110			SK003P/GL		100
1.6 2WD (SF416) Ch. 00109592 → (AH 14)	1990 - 11.96											
1.6 4WD (SF416) Ch. 00102384 → (AJ 14)	1990 - 11.96											
1.3 (SF413) (AK 35)	09.91 - 11.96			SK008A/GL			110			SK003P/GL		100

OIL
GAS

OIL
GAS

SUZUKI (J)

SWIFT III

1.3	(RS413)	05.05 -			SK020AS/GL					SK020P/GL	$\frac{1}{0}$	
1.5	(RS415)	05.05 -			SK020AD/GL							

SX4

1.5L 2WD					FI338AS/GL					FI338P/GL	$\frac{1}{0}$	
1.6L VVT 2WD					FI338AD/GL							
1.9L 2WD												
excl.												
1.6L VVT 4WD					FI348AS/GL					FI348P/GL	$\frac{1}{0}$	
1.9L 4WD					FI348AD/GL							

VITARA / ESCUDO / SANTANA / SIDEKICK

2 (白)		07.88 - 03.98			SK002AS/GL		120			SK002P/GL	$\frac{1}{0}$	60
4 (白)		01.91 - 03.98			SK002AD/GL							
4 (白)		01.91 - 03.98			SK002AS/GL		120			SK002P/GL	$\frac{1}{0}$	60
4 (白)					SK002AD/GL							

WAGON R+

1.0 (SR410)	(MA61)	05.98 - 05.00			SK019AS/GL		110			SK019P/GL	$\frac{0}{0}$	60
1.2 (SR412) incl. 4X4	(MA81, MB81)	05.98 - 05.00			SK019AD/GL							
1.3 (RB413) excl. 4X4	(MA53)	06.00 -			OG052AS/GL				<i>OG052P</i>	OG052P/GL	$\frac{0}{0}$	
					OG052AD/GL							

X-90

(SZ416)	(LA1, LB1)	09.95 -			SK021AS/GL					SK002P/GL	$\frac{1}{0}$	
					SK021AD/GL							

TALBOT (F) (GB)

1100 / 1200 SIMCA

		1967 - 1980		<i>AR003A</i>		$\frac{1}{0}$	30				$\frac{1}{0}$	30
VF 1		1976 - 1980										
VF 2		1967 -		<i>AR003A</i>		$\frac{1}{0}$	30					

1307 / 1308 / 1309

		1974 - 1980		<i>SM008A</i>		$\frac{1}{0}$	25				$\frac{1}{0}$	30
--	--	-------------	--	---------------	--	---------------	----	--	--	--	---------------	----

1510

1510, incl. Alpine		1979 - 1984		<i>SM013A</i>		$\frac{1}{0}$	25					30
--------------------	--	-------------	--	---------------	--	---------------	----	--	--	--	--	----

ALPINE

Serie I, II, III		1959 - 1964				$\frac{1}{1}$						
		1970 - 1975				$\frac{1}{1}$						
		1976 - 1980		<i>SM008A</i>		$\frac{1}{0}$	35				$\frac{1}{0}$	40

EXPRESS

Express (→ Fiat Ducato)		1983 -								FI143P	$\frac{0}{0}$	
-------------------------	--	--------	--	--	--	--	--	--	--	--------	---------------	--

OIL
GAS

OIL
GAS

TALBOT (F) (GB)

HORIZON

1.1, 1.3, 1.5, 1.6, 1.9D	1977 - 1986		SM13A		$\frac{1}{0}$					$\frac{1}{0}$	
--------------------------	-------------	--	-------	--	---------------	--	--	--	--	---------------	--

MATRA - SIMCA BAGHEERA

(XT)	1973 - 1980		AR003A		$\frac{1}{0}$						
------	-------------	--	--------	--	---------------	--	--	--	--	--	--

MINX

Serie I, II, III	1956 - 1963				$\frac{1}{1}$						
	01.67 - 10.70				$\frac{1}{1}$						
	01.67 - 10.70				$\frac{1}{1}$					$\frac{0}{0}$	

SAMBA

excl. Rallye (51A, 51E)	10.81 - 1986		C1006A	C1006AGL	$\frac{1}{1}$			C1006P		$\frac{1}{1}$	
Rallye	10.81 - 1986				$\frac{1}{1}$			C1006P		$\frac{1}{1}$	

SOLARA / MINX / RAPIER

LS, GL, GLS, SX, Alpine	1979 - 1986		SM13A		$\frac{1}{0}$					$\frac{1}{0}$	
-------------------------	-------------	--	-------	--	---------------	--	--	--	--	---------------	--

SUMBEAM

excl. Lotus, Ti	1977 - 1982		SM020A		$\frac{1}{1}$					$\frac{1}{0}$	60
-----------------	-------------	--	--------	--	---------------	--	--	--	--	---------------	----

TAGORA

	1980 - 1985				$\frac{1}{1}$	350		PG006P		$\frac{1}{0}$	60
--	-------------	--	--	--	---------------	-----	--	--------	--	---------------	----

OIL
GAS

OIL
GAS

TOYOTA (J)

4 RUNNER

RN 61	12.87 - 03.89				TY056A/GL					LR001P/GL		
LN 130, VZN 130 4X4	08.89 - 11.95				TY056A/GL					TY057P/GL		
RZN 180, RZN 185, VZN 185	11.95 -											

AURIS

	(ZE15, RE15)	10.06 -			TY068AS/GL					TY068P/GL		
					TY068AD/GL							

AVENSIS

	(AT220, AT221, ST220, CT220)	09.97 - 07.00			TY014AS/GL		140			TY014PS/GL		180
	(ZZT220/221, AZT220, CDT220)	07.00 - 12.02			TY014AD/GL					TY014PD/GL		
	(ZZT250/251, AZT250/251, CDT250)	04.03 - 11.08			TY034AS/GL		140			TY034P/GL		
					TY034AD/GL							

AVENSIS VERSO

2.0, 2.0 D	(ACM20, CLM20)	08.01 - 11.09			TY021AS/GL					TY021P/GL		
					TY021AD/GL							

AYGO

	1.0i, 1.4D	07.05 -			CM027AS	C1027AS/GL				C1027P/GL		
					CM027AD	C1027AD/GL						

CAMRY

	1.8	(SV10)	10.82 - 09.86		ACC19			190		ACC18		TY032P/GL		
	2.0	(SV11, CV11)	06.83 - 09.86											
	1.8 D Turbo	(CV10)	05.85 - 09.86											
	1.8, 2.0	(SV20/21)	10.86 - 08.91		ACC19		TY003A/GL		220		ACC19			
	2.5 V6	(ZV21)	01.89 - 08.91											
	2.0 D Turbo	(CV20)	10.86 - 08.91											
	excl. 4X4													
	2.0 4X4	(SV25)	08.88 - 08.91											
	2.2	(SVX10)	10.91 - 08.96					75				TY018PS/GL		
	3.0 V6	(VCV10)	10.91 - 08.96				TY066AS/GL					TY018PS/GL		
							TY066AD/GL					TY018PD/GL		
	2.2	(SXV20)	09.96 - 2001				TY030AS/GL					TY030PS/GL		
	3.0 V6	(MCV20)	09.96 - 2001				TY030AD/GL					TY030PD/GL		
	2.0, 2.4, 3.0	(ACV30/31, MCV30)	08.01 -				TY031AS/GL					TY031PS/GL		
							TY031AD/GL					TY031PD/GL		
	Wagon 1.8, 2.0	(SV20/21)	10.86 - 02.92		ACC19		TY003A/GL		220		ACC19			
	Wagon 2.0 D Turbo	(CV20)	10.86 - 02.92											
	Wagon 2.2	(SVX10)	03.92 - 12.94				TY018AS/GL					TY018PS/GL		
	Wagon 3.0 V6	(VCV10)	03.92 - 12.94				TY018AD/GL					TY018PD/GL		
	Wagon 2.2	(SVX10)	01.95 - 08.96				TY066AS/GL					TY018PS/GL		
	Wagon 3.0 V6	(VCV10)	01.95 - 08.96				TY066AD/GL					TY018PD/GL		

OIL
GAS

OIL
GAS

TOYOTA (J)

CARINA II / CORONA

1.6 (AT151)	10.83 - 12.87		<i>TY002A</i>	<i>TY002A/GL</i>		230	ACC19			180
1.8, 2.0 D (ST150, CT150)	10.83 - 12.87			<i>TY032A/GL</i>		230	ACC19			180
2.0 (ST151)	08.85 - 12.87									
1.5 (AT171)	12.87 - 12.89			<i>TY002A/GL</i>		205		<i>TY020P/GL</i>		180
1.6 (AT171)	12.87 - 12.89									
1.5 (AT171)	12.89 - 03.92			<i>TY002A/GL</i>		205		<i>TY020P/GL</i>		180
1.6 (AT171)	12.89 - 03.92									
1.8 (ST171)	12.87 - 12.89			<i>TY003A/GL</i>		205		<i>TY020P/GL</i>		180
2.0 (ST171)	12.87 - 12.89									
1.8 D, 2.0 D (CT170)	12.87 - 12.89									
1.8 (ST171)	12.89 - 03.92			<i>TY003A/GL</i>		205		<i>TY020P/GL</i>		180
2.0 (ST171)	12.89 - 03.92									
1.8 D, 2.0 D (CT170)	12.89 - 06.93									
Wagon 1.5 (AT171)	12.87 - 12.89			<i>TY002A/GL</i>		205		<i>TY020P/GL</i>		180
Wagon 1.6 (AT171)	12.87 - 12.89									
Wagon 1.5 (AT171)	01.90 - 10.92			<i>TY002A/GL</i>		205		<i>TY020P/GL</i>		180
Wagon 1.6 (AT171)	01.90 - 10.92									
Wagon 1.8, 2.0 (ST171)	12.87 - 12.89			<i>TY003A/GL</i>		205		<i>TY020P/GL</i>		180
Wagon 1.8 D, 2.0 D (CT170)	12.87 - 12.89									
Wagon 1.8, 2.0 (ST171)	01.90 - 10.92			<i>TY003A/GL</i>		205		<i>TY020P/GL</i>		180
Wagon 1.8 D, 2.0 D (CT170)	01.90 - 10.92									

CARINA E / CORONA

1.6 (AT190)	02.92 - 01.96	 		<i>TY005AS/GL</i> <i>TY005AD/GL</i>	 		 	<i>TY005PS/GL</i> <i>TY005PD/GL</i>	 	
2.0 excl. GTi (ST191)	02.92 - 01.96	 		<i>TY003A/GL</i> <i>TY005AS/GL</i> <i>TY005AD/GL</i>	 		 	<i>TY005PS/GL</i> <i>TY005PD/GL</i>	 	
2.0 GTi (ST191)	02.92 - 01.96	 			 		 	<i>TY005PS/GL</i> <i>TY005PD/GL</i>	 	
2.0 D, 2.0 TD (CT190)	02.92 - 01.96	 		<i>TY003A/GL</i> <i>TY005AS/GL</i> <i>TY005AD/GL</i>	 		 	<i>TY005PS/GL</i> <i>TY005PD/GL</i>	 	
Wagon 1.6 (AT190)	11.92 - 05.93	 		<i>TY005AS/GL</i> <i>TY005AD/GL</i>	 		 	<i>TY014PS/GL</i> <i>TY014PD/GL</i>	 	
Wagon 1.6 (AT190)	06.93 - 02.94	 		<i>TY005AS/GL</i> <i>TY005AD/GL</i>	 		 	<i>TY014PS/GL</i> <i>TY014PD/GL</i>	 	
Wagon 1.6 (AT190)	03.94 - 01.96	 		<i>TY005AS/GL</i> <i>TY005AD/GL</i>	 		 	<i>TY005PS/GL</i> <i>TY005PD/GL</i>	 	
Wagon 2.0 (ST191)	11.92 - 05.93	 		<i>TY003A/GL</i> <i>TY005AS/GL</i> <i>TY005AD/GL</i>	 		 	<i>TY014PS/GL</i> <i>TY014PD/GL</i>	 	
Wagon 2.0 D (CT190)	11.92 - 05.93	 		<i>TY003A/GL</i> <i>TY005AS/GL</i> <i>TY005AD/GL</i>	 		 	<i>TY014PS/GL</i> <i>TY014PD/GL</i>	 	
Wagon 2.0 (ST191)	06.93 - 09.97	 		<i>TY003A/GL</i> <i>TY005AS/GL</i> <i>TY005AD/GL</i>	 		 	<i>TY014PS/GL</i> <i>TY014PD/GL</i>	 	
Wagon 2.0 D (CT190)	06.93 - 02.94	 		<i>TY003A/GL</i> <i>TY005AS/GL</i> <i>TY005AD/GL</i>	 		 	<i>TY005PS/GL</i> <i>TY005PD/GL</i>	 	
Wagon 2.0 D (CT190)	03.94 - 01.96	 		<i>TY003A/GL</i> <i>TY005AS/GL</i> <i>TY005AD/GL</i>	 		 	<i>TY005PS/GL</i> <i>TY005PD/GL</i>	 	

OIL
GAS

OIL
GAS

TOYOTA (J)

CELICA

1.6, 1.8, 2.0 (AT160, ST160, ST162)	08.85 - 08.87	ACC19		<i>TY032A</i> /GL		200	ACC18	<i>TY033P</i> /GL		150
1.6, 1.8, 2.0 excl. Turbo, 4X4 (AT160, ST162)	08.87 - 08.89			<i>TY033A</i> /GL		200		<i>TY020P</i> /GL		150
1.6, 2.0 excl. ABS (AT180, ST182)	09.89 - 10.93			<i>TY008A</i> /GL		160		<i>TY008P</i> /GL		195
2.0 Turbo 4X4 (ST185)	09.89 - 10.93			<i>TY008A</i> /GL		160		<i>TY009PS</i> /GL		
1.8 (AT200)	11.93 - 11.99			<i>TY010A</i> /GL				<i>TY010PS</i> /GL		
2.0 excl. GT 4X4 (ST202)	11.93 - 11.99							<i>TY010PD</i> /GL		
2.0 GT 4X4 (ST205)	11.93 - 11.99			<i>TY044AS</i> /GL				<i>TY044PS</i> /GL		
				<i>TY044AD</i> /GL				<i>TY044PD</i> /GL		
1.8 (ZZT230)	08.99 - 11.99			<i>TY045AS</i> /GL				<i>TY045P</i> /GL		
				<i>TY045AD</i> /GL						
1.8 (ZZT230)	10.99 - 08.00			<i>TY045AS</i> /GL				<i>TY046P</i> /GL		
				<i>TY045AD</i> /GL						
(ZZT23#)	08.00 -			<i>TY045AS</i> /GL				<i>TY046P</i> /GL		
				<i>TY045AD</i> /GL						

COASTER

RU 19, BU 19	02.72 - 07.77			DA002A	/GL				FI019P		
RB 10, 11, 12, 13, BB 10	08.77 - 04.82		FI019P						FI019P		

COROLLA

1.3 (AE80)	05.83 - 05.87			<i>TY002A</i>	<i>TY002A</i> /GL		190		<i>TY032P</i> /GL		135
1.5 (EE80)	05.83 - 05.87										
1.6 excl. GT (AE82)	05.83 - 05.87										
1.8 D (CE80)	05.83 - 05.87				<i>TY032A</i> /GL				<i>TY032P</i> /GL		
1.6 GT (AE82)	10.84 - 05.87				<i>TY032A</i> /GL						
1.3 (EE90)	06.87 - 12.92				<i>TY002A</i> /GL		250		<i>TY002PS</i> /GL		100
1.6 excl. GTI	06.87 - 12.92								<i>TY002PD</i> /GL		
	06.87 - 12.92							ACC19			
1.6 GTi (AE92)	06.87 - 12.92				<i>TY003A</i> /GL		250		<i>TY002PS</i> /GL		100
									<i>TY002PD</i> /GL		
1.8 D (CE90, CE92)	06.87 - 06.93				<i>TY003A</i> /GL		250		<i>TY002PS</i> /GL		100
									<i>TY002PD</i> /GL		
								ACC19			
1.3 (EE100, EE101)	05.92 - 04.97				<i>TY004AS</i> /GL		150		<i>TY004PS</i> /GL		240
1.6 (AE101)	05.92 - 04.97				<i>TY004AD</i> /GL				<i>TY004PD</i> /GL		
2.0 D (CE100)	05.92 - 04.97										
1.3, 1.4, 1.6 (EE110, AE/EE111)	04.97 - 01.02								<i>TY004PS</i> /GL		
1.8 (AE115)	04.97 - 01.02				<i>TY004AS</i> /GL		150		<i>TY004PD</i> /GL		
2.0 D (CE110, CE111)	04.97 - 01.02				<i>TY004AD</i> /GL						
1.4 (ZZE111)	10.99 - 09.01								<i>TY004PS</i> /GL		
1.6 (ZZE112)	10.99 - 09.01				<i>TY004AS</i> /GL		150		<i>TY004PD</i> /GL		
1.9 D (ZZE110)	10.99 - 09.01				<i>TY004AD</i> /GL						

OIL
GAS

OIL
GAS

TOYOTA (J)

COROLLA

1.4 1.6 excl. Auto. 2.0 TD	(ZZE120) (ZZE121) (CDE120)	10.01 - 10.01 - 10.01 -	← →		TY047AS/GL TY047AD/GL	 			TY047P/GL		
1.6 Auto.	(ZZE121)	10.01 -	← →		TY047AS/GL TY047AD/GL	 			TY048P/GL		
Station Wagon 1.3, 1.6	(EE90, AE92)	06.87 - 06.92			TY002A/GL		250	← → ACC19	TY002PS/GL TY002PD/GL	 	100
Station Wagon 1.6 4X4	(AE95)	10.87 - 12.92							TY002P/GL		
Station Wagon 1.8 D	(CE90, CE92)	06.87 - 06.92			TY003A/GL		250	← → ACC19	TY002PS/GL TY002PD/GL	 	100
Wagon 1.3 Wagon 1.6 Wagon 2.0 D	(EE100, EE101) (AE101) (CE100)	05.92 - 04.97 05.92 - 04.97 05.92 - 04.97	← →		TY004AS/GL TY004AD/GL	 	150	← →	TY004PS/GL TY004PD/GL	 	240
Wagon 1.3, 1.4, 1.6 Wagon 1.8 Wagon 2.0 D	(EE110, AE/EE111) (AE115) (CE110, CE111)	04.97 - 09.01 04.97 - 09.01 04.97 - 09.01	← →		TY004AS/GL TY004AD/GL	 	150	← →	TY004PS/GL TY004PD/GL	 	
1.4 1.6 2.0 TD	(ZZE120) (ZZE121) (CDE120)	10.01 - 10.01 - 10.01 -	← →		TY047AS/GL TY047AD/GL	 			TY047P/GL		

COROLLA VERSO

1.6 1.8 2.0 TD	(ZZE121) (ZZE122) (CDE120)	09.01 - 12.03 09.01 - 12.03 09.01 - 12.03	← →		TY047AS/GL TY047AD/GL	 			TY047P/GL		
1.6 1.8 2.0 TD	(ZNR10) (ZNR11) (CUR10)	02.04 - 03.09 02.04 - 03.09 02.04 - 03.09	← →		TY028AS/GL TY028AD/GL	 			TY028P/GL		

CROWN

1.9 2.0 2.3	(RS41) (MS41) (MS45)	01.65 - 08.67 01.65 - 08.67 01.65 - 08.67			MT024A/GL							
2.0 2.3	(MS46) (RS50, RS60) (MS51, MS55)	01.65 - 07.67 09.67 - 09.74 09.67 - 01.71			MT024A/GL MT024A/GL	 						
2.0, 2.3 2.6	(RS80, MS64) (MS65/75/85/95)	10.74 - 08.79 02.71 - 08.79			MT024A/GL							
2.0 2.6, 2.8 2.2 D	(RS110) (MS111, MS112) (LS110)	09.79 - 07.83 09.79 - 07.83 09.79 - 07.83			MT024A/GL		50		OG007P	OG007P/GL		40
2.0 2.5 D 2.8	(YS120) (LS120) (MS122)	08.83 - 09.87 08.83 - 09.87 08.83 - 09.87			MT024A/GL		50		OG007P	OG007P/GL		40
2.8	(MS123, MS125)	08.83 - 09.87										
2.0 2.3	(MS56, RS56) (MS57, RS57)	08.67 - 01.71 08.67 - 01.71			MT024A/GL							

TOYOTA

OIL
GAS

OIL
GAS

TOYOTA (J)

CROWN

2.3 (MS67)	02.71 - 01.73			<u>MT024A/GL</u>	$\frac{1}{2}$									
2.6 (MS63/68/83/88)	02.71 - 08.79													
2.6 (MS111)	09.79 - 07.80			<u>MT024A/GL</u>	$\frac{1}{2}$			<u>OGN07P</u>	<u>OGN07P/GL</u>	$\frac{1}{2}$	40			
2.8 (MS112, MS122)	09.79 - 09.87													
2.2 D (LS110)	09.79 - 07.81													

DYNA

RU/JU/BU 10, 12, 15	01.69 - 07.77			DA002A/GL	$\frac{1}{2}$			FI019P		$\frac{1}{2}$				
RU/JU/BU 10, 12, 15 H	01.69 - 07.77													
HU 15 H	01.72 - 07.77		FI019P		$\frac{1}{2}$			FI019P		$\frac{1}{2}$				
BU 20, 30, 35, 36	07.77 - 11.84		<u>NI027P</u>	<u>NI027P/GL</u>	$\frac{1}{2}$			FI019P		$\frac{1}{2}$				
RU 20, 30	07.77 - 11.84													
HU 30, 50	07.77 - 11.84													
JU 20	07.77 - 11.84													
BU 75	08.87 - 05.95				$\frac{1}{2}$					$\frac{1}{2}$				
BU 85														

DYNA 100

LH 80	08.85 - 05.95		<u>NI060A</u>		$\frac{1}{2}$					$\frac{1}{2}$				
YH 81	08.85 - 05.95													
LY 100	05.95 -		<u>NI060A</u>		$\frac{1}{2}$					$\frac{1}{2}$				

HI-ACE

PH 10, LH 10, RH 10 series	10.67 - 01.77				$\frac{1}{2}$	60		FI019P		$\frac{1}{2}$	50			
RH 20, RH 30, RH 40 series excl. RH22, RH24	02.77 - 11.82													
LH 20, LH 30, LH 40 series	02.77 - 11.82													
RH 22	02.77 - 11.82				$\frac{1}{2}$	60				$\frac{1}{2}$				
LH 50, LH 60, LH 70 series	11.82 - 12.83			<u>NI047A/GL</u>	$\frac{1}{2}$	60			DA002A/GL	$\frac{1}{2}$	50			
YH 50, YH 60, YH 70 series, YH (Serie 50,60,70)	11.82 - 12.83													
LH 50, LH 60, LH 70 series 4X2	01.84 - 08.89			<u>NI047A/GL</u>	$\frac{1}{2}$	60				$\frac{1}{2}$	50			
YH 50, YH 60, YH 70 series 4X2	01.84 - 08.89													
LH 56, LH 66, YH 56, YH 66 series 4X4	08.86 - 08.89			<u>TY049A/GL</u>	$\frac{1}{2}$	60				$\frac{1}{2}$				
LH 102, LH 112 4X2	08.89 - 08.95			NI012A/GL	$\frac{1}{2}$	40			<u>TY049P/GL</u>	$\frac{1}{2}$				
RZH 102/103/112/113/115	08.89 - 08.95													
LH 108, LH 118, RZH 109, RZH 119 4X4	08.89 - 08.95			<u>TY049A/GL</u>	$\frac{1}{2}$	40			<u>TY050P/GL</u>	$\frac{1}{2}$	25			
LXH 12, LXH 22	08.95 - 10.99			NI012A/GL	$\frac{1}{2}$	40			TY051P/GL	$\frac{1}{2}$				
RCH 12, RCH 13, RCH 22, RCH 23 4X2														
LXH 18, LXH 28	08.95 - 07.99			<u>TY049A/GL</u>	$\frac{1}{2}$				TY052P/GL	$\frac{1}{2}$				
RCH 18, RCH 19, RCH 28, RCH 29 4X4														
KLH 12, KLH 22	07.99 -			NI012A/GL	$\frac{1}{2}$				TY052P/GL	$\frac{1}{2}$				
LXH 12, LXH 22														
RCH 12, RCH 13, RCH 22, RCH 23 4X2														
KLH 18, KLH 28 4X4	07.99 -			<u>TY049A/GL</u>	$\frac{1}{2}$				TY052P/GL	$\frac{1}{2}$				
LXH 19, LXH 29 4X4														
RCH 19, RCH 22 4X4														



		OIL	GAS				OIL	GAS		
--	--	------------	------------	--	--	--	------------	------------	--	--

TOYOTA (J)

HI-LUX

RN 10/13/15/16/20 4X2	01.68 - 01.79				$\frac{1}{2}$	80		FI019P			60
RN 22/25/27/28 4X2	01.68 - 01.79										
RN 30/31/32/33/34/35 4X2	01.78 - 03.84				$\frac{1}{2}$	80		FI019P			60
RN 40/41/42/44 4X2	01.78 - 03.84										
LN 30/40 4X2	01.78 - 03.84										
RN 36/39/46 4X4	01.79 - 07.83			<u>TY053A/GL</u>	$\frac{1}{2}$	60			MT001P/GL		60
LN 36/46 4X4	01.79 - 07.83										
LN 50/51/55/56 4X2	08.83 - 08.88			<u>TY054A/GL</u>	$\frac{1}{2}$	85	N.D	FI019P			60
YN 50/51/52/55/56 4X2	08.83 - 08.88										
YN 57/58/, RN 50/55 4X2	08.83 - 08.88										
LN 60/61/65 4X4	08.83 - 08.88			<u>TY053A/GL</u>	$\frac{1}{2}$	60			<u>TY053P/GL</u>		60
YN 60/61/62/65/67 4X4	08.83 - 08.88										
LN 85/90 4X2	08.88 - 08.97			<u>TY054A/GL</u>	$\frac{1}{2}$	45			NI010P/GL		25
YN 85/90 4X2	08.88 - 08.97										
LN 105 4X4	08.88 - 08.97			TY055A/GL	$\frac{1}{2}$	45			TY055P/GL		25
YN 106 4X4	08.88 - 08.97										
LN 108, LN110 4X4	08.88 - 08.97			TY056A/GL	$\frac{1}{2}$	45			TY055P/GL		25
RN 106, RN110 4X4	08.88 - 08.97										
YN 110 4X4	08.88 - 08.97										
LN 145, LN150 4X2	08.97 - 08.01			<u>TY054A/GL</u>	$\frac{1}{2}$	45			TY069P/GL		
LN 165, LN170 4X4	08.97 - 08.01			TY056A/GL	$\frac{1}{2}$				TY056PS/GL		
RZN168, RZN173 4X4	08.97 - 08.01								TY056PD/GL		
KDN145, KDN150	08.01 -			<u>TY054A/GL</u>	$\frac{1}{2}$				TY069P/GL		
KDN165, KDN170, KDN190	08.01 -			TY056A/GL	$\frac{1}{2}$				TY056PS/GL		
									TY056PD/GL		

LAND CRUISER

FJ 40, FJ 43, FJ 45	03.69 - 04.86			DA002A/GL		60			MT001P/GL		60
BJ 40, BJ 43	02.74 - 10.84										
FJ 55, BJ 55	03.69 - 03.71				$\frac{1}{2}$			FI019P			
FJ 42	03.69 - 03.72			DA002A/GL		60			MT001P/GL		60
HJ 45	04.72 - 07.80										
FJ 55, BJ 55, FJ 56V	04.71 - 07.80				$\frac{1}{2}$				MT001P/GL		60
BJ 42, BJ 45, BJ 46	08.80 - 10.84			DA002A/GL		60			MT001P/GL		60
HJ 47	08.80 - 06.85										
BJ 70, BJ 71, BJ 73	1984 - 12.89			<u>TY025A/GL</u>	$\frac{1}{2}$	50			<u>TY053P/GL</u>		40
BJ 75, HJ 75	1984 - 12.89			<u>TY025A/GL</u>	$\frac{1}{2}$	50					
LJ 70, LJ 73	1984 - 12.89			TY058A/GL	$\frac{1}{2}$	50			TY058P/GL	$\frac{1}{2}$	60
RJ 70, RJ 73	1984 - 12.89								LR001P/GL		60
BJ 60, FJ 60, FJ 62, HJ 60, HJ 61 (WGG)	08.80 - 10.85			<u>TY059A/GL</u>	$\frac{1}{2}$	50			MT001P/GL		30
Station Wagon (Model #J6##G-)											
BJ 60, FJ 60, FJ 62, HJ 60, HJ 61 (WGV)	08.80 - 10.85			<u>TY025A/GL</u>	$\frac{1}{2}$	50			MT001P/GL		30
(Model#J6##V-)											
BJ 60, FJ 60, FJ 62, HJ 60, HJ 61 (WGG)	10.85 - 08.87			<u>TY059A/GL</u>	$\frac{1}{2}$	50			LR001P/GL		50
Station Wagon (Model#J6##G-)											
BJ 60, FJ 60, FJ 62, HJ 60, HJ 61 (WGV)	10.85 - 08.87			<u>TY025A/GL</u>	$\frac{1}{2}$	50			LR001P/GL		50
(Model#J6##V-)											

OIL
GAS

OIL
GAS

TOYOTA (J)

LAND CRUISER

HJ 60, HJ 61	08.87 - 12.89			TY059A/GL	1/0	50			LR001P/GL	0/0	50
HZJ 70, HZJ 73	01.90 - 08.99			TY025A/GL	1/0	50			TY025P/GL	0/0	50
PZJ 70, PZJ 73	01.90 - 08.99										
LJ 70/73/77/79	01.90 - 04.93			TY060A/GL	0/1	50			TY060P/GL	0/1	50
RJ 70, RJ 73	01.90 - 04.93										
LJ70, LJ73, RJ70, KZJ 70	05.93 - 12.94										
HZJ 75, PZJ 75	01.90 - 08.99			TY025A/GL	1/0				TY061P/GL	0/0	
HZJ 71, HZJ 74	08.99 - 08.01			TY026A/GL	1/1				TY025P/GL	0/0	
HZJ 78	08.99 - 08.01			TY026A/GL	1/1				TY026P/GL	0/0	
HZJ 79	08.99 - 08.01			TY026A/GL	1/1				TY062P/GL	0/0	
FJ 80, HDJ 80, HZJ 80	01.90 - 12.98			TY063A/GL	1/1	50			TY063P/GL	1/0	50
KZJ7#, RJ7#, LJ70, LJ72	05.93 -			TY060A/GL	0/1				TY060P/GL	0/1	
KZJ 90/95, VZJ 90/95	04.96 - 09.02		TY064A					TY064P		1/0	
HDJ 100/105, UZJ 100/105 excl.	01.98 -		TY065A		1/0			TY065P		1/0	
KDJ 120, KDJ 125 excl.	09.02 -			TY024A/GL					TY024P/GL	1/0	

LITE-ACE

	(CR21, KR21, YR22)	01.92 -			MT025A/GL	1/1					1/0
	(CR27, KR27, YR29)	01.92 -			MT025A/GL	1/1					0/0
	(KM67)	01.92 -			MT025A/GL	1/1					0/0

MR-2

1.6	(AW10, AW11)	11.84 - 06.90			TY017A/GL		175				
2.0 16V	(SW20)	1990 - 2000			TY041A/GL					TY041P/GL	
1.8	(W3)	2000 -			TY042S/GL					TY042PS/GL	
					TY042D/GL					TY042PD/GL	

PASEO

	(EL54)	08.95 - 07.99			TY013AS/GL					TY013P/GL	
					TY013AD/GL						

PICNIC

	(SXM10, CXM10)	09.96 - 05.01			TY029AS/GL					TY029P/GL	1/0
					TY029AD/GL						

PREVIA

TCR 10, TCR 20 4X2, 4X4 		06.90 - 08.00			TY019AS/GL					TY019P/GL	0/1
					TY019AD/GL						
TCR 11, TCR 21 4X2, 4X4 		06.90 - 08.00			TY019AS/GL					TY025P/GL	1/1
					TY019AD/GL						
	(R30)	04.00 -			TY036AS/GL					TY036P/GL	1/0
					TY036AD/GL						



		OIL	GAS				OIL	GAS		
--	--	------------	------------	--	--	--	------------	------------	--	--

TOYOTA (J)

PRIUS

	(HW1)	08.00 - 07.03			<u>TY037AS/GL</u>					<u>TY037P/GL</u>		
					<u>TY037AD/GL</u>							
	(HW2)	08.03 - 03.09			<u>TY038AS/GL</u>					<u>TY038P/GL</u>		
					<u>TY038AD/GL</u>							
	1.8 Hybrid (ZVW3)	04.09 -										

RAV-4 / FUN CRUISER

	(SXA10, SXA11)	04.94 - 06.00			<u>TY027AC/GL</u>		150			<u>TY022P/GL</u>		60
excl. 235/60 R 16"					<u>TY027AS/GL</u>		140					
					<u>TY027AD/GL</u>							
ACA 20, ZCA 25	(XA2)	06.00 - 11.05			<u>TY022AS/GL</u>		140			<u>TY022P/GL</u>		60
					<u>TY022AD/GL</u>							
ACA 21, ZCA 26	(XA2)	06.00 - 11.05			<u>TY023AS/GL</u>		140			<u>TY022P/GL</u>		60
					<u>TY023AD/GL</u>							
	(ACA, ACE, ALA)	03.06 -			<u>TY067AS/GL</u>					<u>TY067P/GL</u>		
					<u>TY067AD/GL</u>							

STARLET

	1.0, 1.3, 1.3 Turbo (EP80/81/82)	12.89 - 05.94			<u>TY015AS/GL</u>					<u>TY016P/GL</u>		55
	1.5 D (NP80)	12.89 - 05.94			<u>TY015AD/GL</u>							
	1.0, 1.3, 1.3 Turbo (EP80/81/82)	06.94 - 03.96			<u>TY015AS/GL</u>					<u>TY015P/GL</u>		55
	1.5 D (NP80)	06.94 - 03.96			<u>TY015AD/GL</u>							
	1.3 (EP91)	01.96 - 03.99			<u>TY015AS/GL</u>					<u>TY013P/GL</u>		
					<u>TY015AD/GL</u>							

SUPRA / SOARER

3.0 24V (MA70)	01.86 - 05.93				<u>TY039A/GL</u>					<u>TY039P/GL</u>		
3.0 24V (JZA80)	05.93 - 01.96				<u>TY040A/GL</u>					<u>TY040P/GL</u>		

YARIS

	1.0 (SCP10)	04.99 - 09.05			<u>TY011A/GL</u>		120		<u>TY011P</u>	<u>TY011P/GL</u>		70
	1.3 (NCP10)	04.99 - 09.05										
	1.4 TD (NLP10)	04.99 - 09.05										
	1.5 TS (NCP13)	01.01 - 09.05			<u>TY011A/GL</u>		120		<u>TY011P</u>	<u>TY011P/GL</u>		60
	(SCP9, NSP9, KSP9, NCP9, ZSP9)	01.06 -			<u>TY043AS/GL</u>					<u>TY043P/GL</u>		
					<u>TY043AD/GL</u>							
	(NLP13, NSP13, NCP13, KSP13)	09.11 -			<u>TY043AS/GL</u>					<u>TY043P/GL</u>		
					<u>TY043AD/GL</u>							

YARIS VERSO

	(NCP20/21/22, NLP20/22)	08.99 - 09.05			<u>TY012A/GL</u>		120			<u>TY012P/GL</u>		70
--	-------------------------	---------------	--	--	------------------	--	-----	--	--	------------------	--	----

OIL
GAS

OIL
GAS

VAUXHALL (GB)

AGILA

	(H00)	09.00 -	 		OG052AS/GL OG052AD/GL	 			<i>OG052P</i>	OG052P/GL		
--	-------	---------	------	--	--------------------------	------	--	--	---------------	-----------	--	--

ASTRA MK I / BELMONT

		09.79 - 08.86		ACC88	OG013A	OG013A/GL		140		OG013P	OG013P/GL		25
		09.79 - 08.86		ACC88	OG013A	OG013A/GL		140		<i>OG014P</i>			25

ASTRA MK II / BELMONT

excl. GSI, GTE → Ch. J2791967 → Ch. J5273427		09.84 - 07.88		ACC88	OG013A	OG013A/GL		140		OG013P	OG013P/GL		25
excl. GSI, GTE Ch. J2791968 → Ch. J5273428 →		08.88 - 08.91		ACC88	OG013A	OG013A/GL		140		OG024P	OG024P/GL		25
GSI, GTE → Ch. J2791967 → Ch. J5273427		09.84 - 07.88		ACC59		OG013A/GL		140			OG013P/GL		25
GSI, GTE Ch. J2791968 → Ch. J5273428 →		08.88 - 08.91		ACC59		OG013A/GL		140			OG024P/GL		25
		09.84 - 08.91		ACC88	OG013A	OG013A/GL		140		OG034P	OG034P/GL		25

ASTRA MK III

excl. GT, GSI		09.91 - 09.98		ACC88	OG029A	OG029A/GL		150		OG024P	OG024P/GL		40
GT		09.91 - 09.98		ACC59		OG029A/GL		150			OG024P/GL		40
GSI		09.91 - 09.98				OG029A/GL		150			<i>OG044P/GL</i>		40
		09.91 - 09.98		ACC88	OG029A	OG029A/GL		150	excl.	OG034P	OG034P/GL		40
excl. 2.0 GSI		09.91 - 09.98				OG029A/GL		150			OG024P/GL		40
2.0 GSI		09.91 - 09.98				OG029A/GL		150			OG024P/GL		40

ASTRA MK IV

excl.		04.98 - 04.04	 		<i>OG041AS</i> <i>OG041AD</i>	OG041AS/GL OG041AD/GL	 	80		<i>OG041P</i>	OG041P/GL		60
,		04.98 - 04.04	 		<i>OG041AS</i> <i>OG041AD</i>	OG041AS/GL OG041AD/GL	 	80		<i>OG042P</i>	OG042P/GL		60

ASTRA MK V

,		01.04 - 05.09	 		OG051AS/GL OG051AD/GL	 					OG051P/GL		
		08.04 -	 		OG051AS/GL OG051AD/GL	 					OG065P/GL		

BRAVA

TFR Series 4X2		08.91 -											
TFS Series 4X4		08.91 -			OG055A/GL						N1003P/GL		

OIL
GAS

OIL
GAS

VAUXHALL (GB)

CALIBRA

2.0, 2.0 16V, 2.5 V6 excl. 2.0 Turbo excl.	06.90 - 08.98			OG024A/GL		145	excl.		OG028P/GL	$\frac{1}{0}$	45
---	---------------	--	--	-----------	--	-----	-------	--	-----------	---------------	----

CARLTON

	10.78 - 08.86	ACC88	OG008A	OG008A/GL		130		OG009P		$\frac{1}{0}$	40
	10.78 - 08.86	ACC88	OG008A	OG008A/GL		130		OG007P	OG007P/GL	$\frac{1}{0}$	40
1.8, 2.0, 2.4 2.3 D, 2.3 TD excl.	09.86 - 04.94 09.86 - 04.94		OG023A	OG023A/GL		215		OG033P	OG033P/GL	$\frac{1}{0}$	
2.6, 3.0, 3.0 24V excl. Lotus,	09.86 - 04.94			OG027A/GL		215			OG033P/GL	$\frac{1}{0}$	
 excl.	09.86 - 04.94		OG023A	OG023A/GL				OG032P	OG032P/GL	$\frac{1}{0}$	

CAVALIER

	1975 - 08.81		OG009A		$\frac{1}{0}$	35		OG005P	OG005P/GL	$\frac{1}{0}$	
→ Ch. F1003026	09.81 - 12.85		OG015A	OG015A/GL		120		OG013P	OG013P/GL	$\frac{1}{0}$	
→ Ch. F5000000	09.81 - 12.85										
→ Ch. F6000000	09.81 - 12.85										
Ch. F1003027 → Ch. F5000001 → Ch. F6000001 →	01.85 - 08.88 01.85 - 08.88 01.85 - 08.88	ACC59	OG021A	OG021A/GL		120		OG013P	OG013P/GL	$\frac{1}{0}$	
, 1.4, 1.4, 1.6, 1.6, 1.7 D , 1.8, 1.8, 2.0, 1.7 TD excl. 4X4	09.88 - 11.95 09.88 - 11.95		OG024A	OG024A/GL		145	excl.	OG024P	OG024P/GL	$\frac{1}{0}$	40
, 2.0 16V excl. 4X4 → Ch. NV199999 → Ch. N1999999 → Ch. N5999999	09.88 - 12.92		OG024A	OG024A/GL		145	excl.	OG033P	OG033P/GL	$\frac{1}{0}$	40
, 2.0 16V excl. 4X4 Ch. NV199999 → Ch. N1999999 → Ch. N5999999 →	01.93 - 11.95			OG024A/GL		145	excl.	OG024P	OG024P/GL	$\frac{1}{0}$	40
, 1.8, 2.0, 2.0 16V excl. Turbo 4X4	09.88 - 11.95			OG024A/GL		145	excl.	OG033P	OG033P/GL	$\frac{1}{0}$	40
→ Ch. F1003026 → Ch. F5000000 → Ch. F6000000	09.81 - 12.85 09.81 - 12.85 09.81 - 12.85	ACC59	OG015A	OG015A/GL		120				$\frac{0}{0}$	50
Ch. F1003027 → Ch. F5000001 → Ch. F6000001 →	01.85 - 08.88 01.85 - 08.88 01.85 - 08.88	ACC59	OG021A	OG021A/GL		120				$\frac{0}{0}$	50

CHEVETTE

	03.75 - 12.85		OG009A		$\frac{1}{0}$	50		OG009P		$\frac{1}{0}$	40
,	03.75 - 12.85		OG009A		$\frac{1}{0}$	50			OG001P/GL	$\frac{1}{0}$	40

OIL
GAS

OIL
GAS

VAUXHALL (GB)

COMBO

	07.94 - 10.01		OG016A	OG016A/GL		70		OG026P			25
	10.01 -		<u>OG030AS</u>	OG030AS/GL		90		OG054P	OG054P/GL		60
Van, Tour			<u>OG030AD</u>	OG030AD/GL							

CORSA

incl. CorsaVan excl. GSI	03.93 - 09.00		OG016A	OG016A/GL		70		OG016P	OG016P/GL		
GSI, GSI 16V	03.93 - 09.00			OG016A/GL		70			OG016P/GL		
1.0, 1.2 excl.	09.00 -		<u>OG030AS</u>	OG030AS/GL		60	1	OG030P	OG030P/GL		30
1.0, 1.2 	09.00 -		<u>OG030AS</u>	OG030AS/GL		60	2	OG053P	OG053P/GL		30
1.7 Di excl.	09.00 -		<u>OG030AS</u>	OG030AS/GL		60	1	OG030P	OG030P/GL		30
1.7 Di 	09.00 -		<u>OG030AS</u>	OG030AS/GL		60	2	OG053P	OG053P/GL		30
1.4 excl.	09.00 -		<u>OG030AS</u>	OG030AS/GL		60	2	OG053P	OG053P/GL		30
1.4 	09.00 -		<u>OG030AS</u>	OG030AS/GL		60	2		OG053P/GL		30
1.8, 1.7DTi excl.	09.00 -		<u>OG030AS</u>	OG030AS/GL		60	2	OG053P	OG053P/GL		30
1.8, 1.7DTi 	09.00 -		<u>OG030AS</u>	OG030AS/GL		60	2		OG053P/GL		30

1 2	Vedi disegno/nota Opel Corsa a pagina 101	Siehe Opel Corsa Zeichnung/Anmerkung auf Seite 101
	See drawing/note Opel Corsa on page 101	Ver dibujo/anotación Opel Corsa a la página 101
	Voir plan/note Opel Corsa à la page 101	Ver figura/note Opel Corsa na página 101

CORSA MK IV

	07.06 -			OG057AS/GL					OG057P/GL		
				OG057AD/GL							

FRONTERA

incl. sport → Ch. SV720102	03.92 - 02.95			NI010A/GL			60		<u>OG031P</u>	OG031P/GL		60
incl. sport Ch. SV720103 →	02.95 - 10.98			OG043A/GL			60		<u>OG031P</u>	OG031P/GL		60
incl. sport	11.98 -			OG047A/GL			60			OG047P/GL		60

MERIVA

	01.03 - 03.10		<u>OG030AS</u>	OG030AS/GL				OG054P	OG054P/GL		
			<u>OG030AD</u>	OG030AD/GL							

MONTEREY

	09.91 - 03.95			OG055A/GL			60			OG046P/GL		60
	04.95 - 07.98			OG056A/GL			60			OG046P/GL		60
	01.98 -			OG060A/GL						OG060P/GL		

OIL
GAS

OIL
GAS

VAUXHALL (GB)

MOVANO

(E9, F9, J9) 2.8T, 3.3T, 3.5T	07.98 -		RN109A	RN109A/GL		60		RN109P	RN109P/GL		70
3.5T (H9, U9)	07.98 -		RN109A	RN109A/GL		60		<i>RN111P</i>			70

NOVA

incl. NovaVan excl. GT, GTE, GSI	05.83 - 03.93		OG016A	OG016A/GL				OG016P	OG016P/GL		
GT, GTE, GSI	01.88 - 03.93			OG016A/GL					OG016P/GL		

OMEGA

2.0, 2.0 16V, 2.2 16V excl.	05.94 - 07.03			OG036A/GL		200			OG033P/GL		40
2.5 V6, 2.6 V6, 3.0 V6, 3.2 V6	05.94 - 07.03			OG037A/GL		200			OG033P/GL		40
2.0 DTI, 2.2 DTI, 2.5 TD, 2.5 DTI excl.	05.94 - 07.03										
2.0, 2.0 16V, 2.2 16V excl.	05.94 - 07.03			OG036A/GL		200			OG032P/GL		40
2.5 V6, 2.6 V6, 3.0 V6, 3.2 V6	05.94 - 07.03			OG037A/GL		200			OG032P/GL		40
2.0 DTI, 2.2 DTI, 2.5 TD, 2.5 DTI excl.	05.94 - 07.03										

RASCAL

	1986 -		<i>BEN03AS</i>					<i>BEN03P</i>			25
	1986 -		<i>BEN03AD</i>					<i>BEN03P</i>			25

ROYALE

excl.	02.78 - 08.87	ACC88	<i>OG008A</i>	<i>OG008A/GL</i>		140					60
-------	---------------	-------	---------------	------------------	--	-----	--	--	--	--	----

SENATOR

excl.	02.78 - 08.87	ACC88	<i>OG008A</i>	<i>OG008A/GL</i>		140					60
excl. 3.0 24V,	09.87 - 04.94		<i>OG023A</i>	<i>OG023A/GL</i>		215		<i>OG033P</i>	OG033P/GL		40
3.0 24V excl.	09.87 - 04.94			<i>OG027A/GL</i>		215			OG033P/GL		40

SINTRA

	11.96 - 04.99			<i>OG040A/GL</i>				excl.	OG040P/GL		
--	---------------	--	--	------------------	--	--	--	-------	-----------	--	--

TIGRA

1.4 16V, 1.6 16V	07.94 - 12.00	ACC59		OG016A/GL		150			OG016P/GL		50
------------------	---------------	-------	--	-----------	--	-----	--	--	-----------	--	----

VECTRA MK I

1.6, 1.8, 2.0	08.95 - 08.02		<i>OG038AS</i>	OG038AS/GL		80		<i>OG038P</i>	OG038P/GL		100
1.7 TD, 2.0 DTi	01.96 - 08.02		<i>OG039AS</i>	OG039AS/GL		80	N.D.	<i>OG038P</i>	OG038P/GL		100
2.5 V6	08.95 - 08.02		<i>OG039AD</i>	OG039AD/GL		80	H.D.		OG039P/GL		100
1.6, 1.8, 2.0	08.95 - 08.02		<i>OG038AS</i>	OG038AS/GL		80	excl.	<i>OG038P</i>	OG038P/GL		100
1.7 TD, 2.0 DTi	08.95 - 08.02		<i>OG039AS</i>	OG039AS/GL		80	excl.		OG039P/GL		100
2.5 V6	08.95 - 08.02		<i>OG039AD</i>	OG039AD/GL		80					

OIL
GAS

OIL
GAS

VAUXHALL (GB)

VECTRA MK II

excl. 3.0 CDTI excl.	04.02 -			OG049AS/GL	80			OG049P/GL	70
				OG049AD/GL				OG050P/GL	
excl. 3.0 CDTI 	04.02 -			OG050AS/GL	80			OG050P/GL	70
				OG050AD/GL					

VIVARO

	08.01 -			<i>RN10A</i>	RN110A/GL			RN110P/GL	
--	---------	--	--	--------------	-----------	--	--	-----------	--

ZAFIRA

excl. 2.0 Turbo OPC	04.99 - 07.05			OG048AS/GL	70			OG048P/GL	60
				OG048AD/GL					

ZAFIRA MK II

	07.05 -			OG051AS/GL				OG051P/GL	
				OG051AD/GL					

VOLKSWAGEN (D)

BORA

excl. 2.3 V5 excl.	(1J2)	10.98 - 05.05	4	VW034A	VW034A/GL	80		AU028P/GL	30
2.3 V5 	(1J2)	10.98 - 05.05	4	AU018A	AU018A/GL	80		AU028P/GL	30
		10.98 - 05.05							
4motion 4X4 excl. → Ch. 1J-X-999000	(1J2)	10.98 - 04.99	4	AU018A	AU018A/GL	80		SD005P/GL	60
4motion 4X4 excl. Ch. 1J-X-999001 →	(1J2)	05.99 - 05.05	4		<i>AU026A</i> GL	80		SD005P/GL	60
4motion 4X4 	(1J2)	05.99 - 05.05	4		<i>AU026A</i> GL	80		AU030P/GL	60
excl. 2.3 V5 excl. , 4motion 4X4	(1J6)	05.99 - 05.05	4	VW034A	VW034A/GL	80		<i>AU018P</i> AU018P/GL	60
2.3 V5, excl. 4motion 4X4	(1J6)	05.99 - 05.05	4		AU018A/GL	80		<i>AU018P</i> AU018P/GL	60
4motion 4X4 excl.	(1J2)	05.99 - 05.05	4		<i>AU026A</i> GL	80		SD005P/GL	60
4motion 4X4 	(1J2)	05.99 - 05.05	4		<i>AU026A</i> GL	80		AU030P/GL	60

- 4**
- ① Vedi disegno/nota Volkswagen Golf a pagina 158
 - Ⓞ See drawing/note Volkswagen Golf on page 158
 - Ⓕ Voir plan/note Volkswagen Golf à la page 158
 - Ⓓ Siehe Volkswagen Golf Zeichnung/Anmerkung auf Seite 158
 - Ⓔ Ver dibujo/ anotación Volkswagen Golf a la página 158
 - Ⓟ Ver figura/ nota Volkswagen Golf na página 158

OIL
GAS

OIL
GAS

VOLKSWAGEN (D)

CADDY I

	(14)	08.82 - 07.92	ACC19	VW008AC	VW008AC/GL		100		FR042P		40
--	------	---------------	-------	---------	------------	--	-----	--	--------	--	----

CADDY II

	(9K9A)	11.95 - 01.04	5	VW029A	VW029A/GL		150		SE014P		40
	(9U7)	06.96 - 12.00									

CADDY III

	(2KA)	03.04 -	6 7		VW036A/GL AU038A/GL					VW039P/GL		
--	-------	---------	----------------------	--	------------------------	--	--	--	--	-----------	--	--

CORRADO

1.8 16V, 1.8 G60	(53I)	08.87 - 12.95			VW016AC/GL		100	ACC68		VW019P/GL		40
2.0, 2.0 16V		08.91 - 12.95	5		VW018A/GL		100					
2.9 VR6	(53I)	09.91 - 12.95	5		VW028A/GL		100			VW019P/GL		40

CRAFTER

, , , 30 excl. H.D.		04.06 -			MR118A/GL					MR118P/GL		
, , , 30 incl. H.D.		04.06 -			MR119A/GL							
, , , 35 excl. H.D. excl.		04.06 -			MR118A/GL					MR118P/GL		
, , , 35 incl. H.D. incl.		04.06 -			MR118A/GL							
, , , 50 incl. H.D. excl.		04.06 -			MR119A/GL					MR119P/GL		
, , , 50 incl.		04.06 -			MR119A/GL							

DERBY

	(86, 86C, 80)	02.77 - 12.84	ACC18	AU005A	AU005A/GL		100	ACC82	AU005P	AU005P/GL		55
--	---------------	---------------	-------	--------	-----------	--	-----	-------	--------	-----------	--	----

EOS

		06.06 -	6 7		VW036A/GL AU038A/GL					VW040P/GL		
--	--	---------	----------------------	--	------------------------	--	--	--	--	-----------	--	--

FOX

1.2, 1.4i, 1.4 TDi	(5Z1)	04.05 -	3		SD003A/GL					VW041P/GL		
--------------------	-------	---------	----------	--	-----------	--	--	--	--	-----------	--	--

6 7

- I** Vedi disegno/nota Volkswagen Golf a pagina 159
- GB** See drawing/note Volkswagen Golf on page 159
- F** Voir plan/note Volkswagen Golf à la page 159
- D** Siehe Volkswagen Golf Zeichnung/Anmerkung auf Seite 159
- E** Ver dibujo/anotación Volkswagen Golf a la página 159
- P** Ver figura/nota Volkswagen Golf na página 159

3

- I** Vedi disegno/nota Volkswagen Polo a pagina 162
- GB** See drawing/note Volkswagen Polo on page 162
- F** Voir plan/note Volkswagen Polo à la page 162
- D** Siehe Volkswagen Polo Zeichnung/Anmerkung auf Seite 162
- E** Ver dibujo/anotación Volkswagen Polo a la página 162
- P** Ver figura/nota Volkswagen Polo na página 162

5

- I** Vedi disegno/nota Volkswagen Golf a pagina 157
- GB** See drawing/note Volkswagen Golf on page 157
- F** Voir plan/note Volkswagen Golf à la page 157
- D** Siehe Volkswagen Golf Zeichnung/Anmerkung auf Seite 157
- E** Ver dibujo/anotación Volkswagen Golf a la página 157
- P** Ver figura/nota Volkswagen Golf na página 157

OIL
GAS

OIL
GAS

VOLKSWAGEN (D)

GOLF I

excl. , H.D.	(17)	04.74 - 05.77		VW008AC	VW008AC/GL		100		VW008P	VW008P/GL		40
excl. , H.D.	(17)	05.77 - 08.83		VW008AC	VW008AC/GL		100		VW008P	VW008P/GL		40
	(155)	01.79 - 08.93			VW008AC/GL		100			VW008P/GL		40

GOLF II

N.D. excl. 1.8 GTI 16V, 1.8 G60, Syncro 4X4, Country	(19E, 1G1)	09.83 - 12.89		VW016AC	VW016AC/GL		100		VW016P	VW016P/GL		40
excl. 1.8 GTI 16V, 1.8 G60, Syncro 4X4, Country	(19E, 1G1)	01.90 - 08.91		VW016AC	VW016AC/GL		100		VW016P	VW016P/GL		40
1.8 GTI 16V	(19E, 1G1)	09.83 - 12.89			VW018ACGL		100			VW019P/GL		40
1.8 GTI 16V	(19E, 1G1)	01.90 - 08.91			VW018AGL		100			VW019P/GL		40
1.8 G60 excl. Syncro 4X4	(19E, 1G1)	04.90 - 08.91			VW018A/GL		100			VW019P/GL		40
1.8 Syncro 4X4 excl. Country	(19E, 1G1)	02.86 - 12.89		VW016AC	VW016AC/GL		100			SE012P/GL		
1.8 Syncro 4X4 excl. Country, Rallye	(19E, 1G1)	01.90 - 08.91		VW021A	VW021A/GL		100			SE012P/GL		

GOLF III

excl. 1.8 GT, 1.9 TD/TDI, GTI, VR6, Syncro 4X4 → Ch. 1H SW062 538 → Ch. 1H SB019 475	(1H1)	09.91 - 08.94		VW021A	VW021A/GL		120		VW016P	VW016P/GL		60
excl. 1.8 GT, 1.9 TD/TDI, GTI, VR6, Syncro 4X4 Ch. 1H SW062 539 → Ch. 1H SB019 476 →	(1H1)	09.94 - 08.97		VW029A	VW029A/GL		120		VW016P	VW016P/GL		60
1.8 GT, 1.9 TD/TDI → Ch. 1H SW062 538 → Ch. 1H SB019 475	(1H1)	09.91 - 08.94			VW021A/GL		120			VW016P/GL		60
1.8 GT, 1.9 TD/TDI Ch. 1H SW062 539 → Ch. 1H SB019 475 →	(1H1)	09.94 - 08.97			VW029A/GL		120			VW016P/GL		60
1.8, 2.0 Syncro 4X4 → Ch. 1H SW062 538 → Ch. 1H SB019 475	(1H1)	01.93 - 08.94		VW021A	VW021A/GL		120			SE012P/GL		
1.8, 2.0 Syncro 4X4 Ch. 1H SW062 539 → Ch. 1H SB019 475 →	(1H1)	09.94 - 08.97		VW029A	VW029A/GL		120			SE012P/GL		
2.0 GTI, 2.0 GTI 16V	(1H1)	09.91 - 08.97			VW028A/GL		120			VW019P/GL		60
2.8 VR6	(1H1)	09.91 - 08.97			VW028A/GL		120			VW019P/GL		60
excl. 2.0, 2.8 VR6 → Ch. 1H SW062538 → Ch. 1H SB019475	(1H5)	09.93 - 08.94		VW021A	VW021A/GL		120		VW030P	VW030P/GL		60



OIL

GAS



OIL

GAS



VOLKSWAGEN (D)

GOLF III

excl. 2.0, 2.8 VR6 Ch. 1H SW062539 → Ch. 1H SB019475 →	(1H5)	09.94 - 04.99	ACC64 ⑤	VW029A	VW029A/GL		120		<u>VW030P</u>	VW030P/GL		60
2.0	(1H5)	09.93 - 04.99	ACC51 ⑤		VW028A/GL		120		<u>VW030P</u>	VW030P/GL		60
1.6, 1.8, 1.9 TDI	(1E7)	09.93 - 08.94	ACC64 ⑤	VW021A	VW021A/GL		120	ACC68	VW016P	VW016P/GL		60
1.6, 1.8, 1.9 TDI	(1E7)	09.94 - 05.98	ACC64 ⑤	VW029A	VW029A/GL		120	ACC68	VW016P	VW016P/GL		60
2.0	(1E7)	09.93 - 05.98	ACC51 ⑤		VW028A/GL		120	ACC68		VW016P/GL		60

⑤

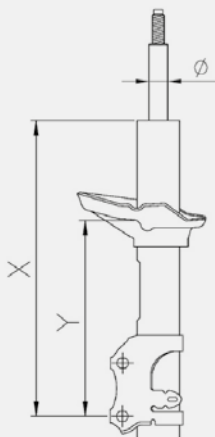

VW021A/VW021A/GL X = 320 mm Y = 228 mm Ø = 20 mm

VW028A/GL X = 342 mm Y = 228 mm Ø = 22 mm

VW029A/VW029A/GL X = 336 mm Y = 228 mm Ø = 20 mm

VW018A/GL X = 318 mm Y = 228 mm Ø = 22 mm

VW018A/VW018A/GL X = 336 mm Y = 228 mm Ø = 22 mm

VW026A/VW026A/GL X = 340 mm Y = 250 mm Ø = 22 mm

OIL
GAS

OIL
GAS

VOLKSWAGEN (D)

GOLF IV

1.4, 1.6, 2.0, 1.9 SDI, 1.9 TDI excl. , 4motion 4X4, 16"	(1J1)	08.97 - 06.05	4	VW034A	VW034A/GL		100		<u>AU018P</u>	AU018P/GL	$\frac{1}{8}$	40
1.4, 1.6, 2.0, 1.9 SDI, 1.9 TDI	(1J1)	08.97 - 06.05	4		AU018A/GL		100			AU028P/GL	$\frac{1}{8}$	40
1.8, 1.8 Turbo, 2.3 V5, 2.8 V6 excl. , 4motion 4X4, 16"	(1J1)	08.97 - 06.05	4		AU018A/GL		100			AU028P/GL	$\frac{1}{8}$	40
4motion 4X4 excl. 16"	(1J1)	07.98 - 06.05	4		AU018A/GL		100			AU036P/GL	$\frac{9}{16}$	40
4motion 4X4 excl. 16"	(1J1)	06.99 - 10.03	4		<u>AU026A</u> /GL		100			AU036P/GL	$\frac{9}{16}$	40
1.4, 1.6, 1.9 SDI, 1.9 TDI excl. , 16"	(1J5)	05.99 - 06.06	4	VW034A	VW034A/GL		100		<u>AU018P</u>	AU018P/GL	$\frac{1}{8}$	60
1.4, 1.6, 1.9 SDI, 1.9 TDI	(1J5)	05.99 - 06.06	4		AU018A/GL		100		<u>AU018P</u>	AU018P/GL	$\frac{1}{8}$	60
1.8, 1.8 Turbo, 2.3 V5 excl. 16"	(1J5)	05.99 - 06.06	4		AU018A/GL		100		<u>AU018P</u>	AU018P/GL	$\frac{1}{8}$	60

	4	Ø 20 mm	Ø 22 mm
		VW034A	AU018A
		VW034A/GL	AU018A/GL
			AU026A/GL

GOLF V

excl. GTI,	(1K1)	10.03 - 12.08	6 7		VW036A/GL AU038A/GL		130			VW036P/GL	$\frac{1}{8}$	70
	(1K1)	01.05 - 12.08	6 7		VW037A/GL AU039A/GL		130			VW037P/GL	$\frac{1}{8}$	70
Plus	(5M)	01.05 -	6 7		VW036A/GL AU038A/GL		130			VW036P/GL	$\frac{1}{8}$	70
excl.	(1K5)	06.07 -	6 7		VW036A/GL AU038A/GL		130			VW036P/GL	$\frac{1}{8}$	70
	(1K5)	06.07 -	6 7		VW037A/GL AU039A/GL		130			VW037P/GL	$\frac{1}{8}$	70

GOLF VI

, , excl.	(5K1, AJ5)	10.08 - 07.09 -	6 7		VW036A/GL AU038A/GL		130			VW036P/GL	$\frac{1}{8}$	70
, , incl.	(5K1, AJ5)	10.08 - 07.09 -	6 7		VW037A/GL AU039A/GL		130			VW037P/GL	$\frac{1}{8}$	70

GOLF VII

, excl. 4X4, S3,	(5G1, BA5)	11.12 - 04.13 -	6 7		<u>VW046A</u> /GL <u>VW045A</u> /GL		130			<u>VW045P</u> /GL	$\frac{1}{8}$	70
, incl. 4X4 excl. S3,	(5G1, BA5)	11.12 - 04.13 -	6 7		<u>VW046A</u> /GL <u>VW045A</u> /GL		130			<u>VW046P</u> /GL	$\frac{1}{8}$	70

OIL
GAS

OIL
GAS

VOLKSWAGEN (D)

JETTA

	(17, 16)	01.73 - 05.77	ACC64	VW008AC	VW008AC/GL		100	ACC84	VW008P	VW008P/GL		40
	(17, 16)	06.77 - 08.83	ACC64	VW008AC	VW008AC/GL		100	ACC84	VW008P	VW008P/GL		40
	(19E, 1G2)	09.83 - 12.92	ACC64	VW016AC	VW016AC/GL		100	ACC68	VW016P	VW016P/GL		40
excl. 1.8 GTI 16V, Syncro 4X4, H.D.			5	VW021A	VW021A/GL		100					
1.8 GTI 16V	(19E, 1G2)	09.83 - 12.89			VW018AC/GL			ACC68		VW019P/GL		40
1.8 GTI 16V	(19E, 1G2)	01.90 - 12.92	5		VW018AGL		100	ACC68		VW019P/GL		40
1.8 Syncro 4X4	(19E, 1G2)	08.87 - 12.89		VW016AC	VW016AC/GL					SE012P/GL		
1.8 Syncro 4X4	(19E, 1G2)	01.90 - 07.91	5	VW021A	VW021A/GL					SE012P/GL		
excl.	(1K2)	09.05 -	6		VW036A/GL					VW036P/GL		10
			7		AU038A/GL							
	(162)	04.10 -	6		VW036A/GL					VW036P/GL		10
			7		AU038A/GL							

LT SERIES

LT 28, LT 28 D, LT 31, LT 31 D, LT 35, LT 35 D	(281, 363)	04.75 - 12.82		VW105A			50		VW105P			40
LT 28, LT 28 D, LT 31, LT 31 D, LT 35, LT 35 D	(281, 363)	12.82 - 12.96		VW105A			50		VW106P			40
LT 40, LT 40 D, LT 45, LT 45 D	(291, 293, 512, 909)	01.75 - 12.82		VW108A			50		VW105P			40
LT 40, LT 40 D, LT 40 TD	(291, 293, 512, 909)	01.83 - 12.96		VW108A			50					
LT 45, LT 45 D, LT 45 TD		08.85 - 12.96										
LT 55, LT 55 D, LT 55 TD		08.85 - 12.96										
4X2, 4X4												
excl. LT 46	(2DM)	04.96 -			MR110A/GL				MR110P			
LT46	(2DX0AE/FE)	04.96 -			MR112A/GL				MR112P			

LUPO

1.0, 1.4, 1.4 16V	(6X1, 6E1)	09.98 - 07.05	ACC19	VW029A	VW029A/GL		55		VW033P	VW033P/GL		70
1.4 TDI, 1.7 SDI	(6X1, 6E1)	09.98 - 07.05	ACC19	VW029A	VW029A/GL		55		VW033P	VW033P/GL		70

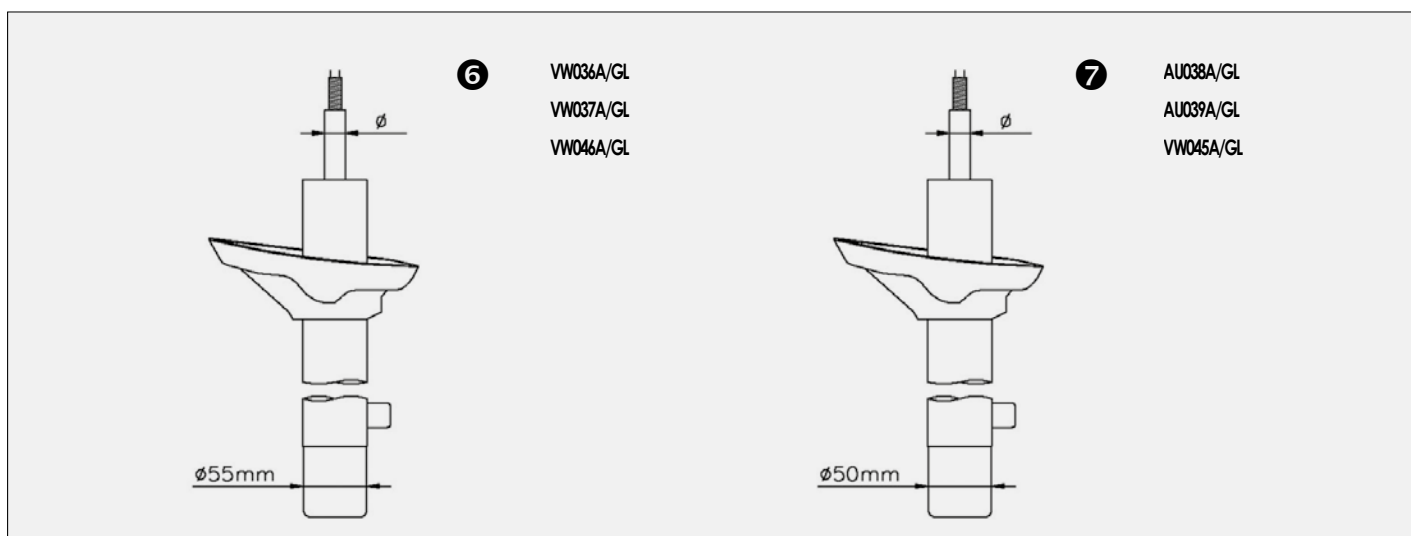
5

① Vedi disegno/nota Volkswagen Golf a pagina 157

Ⓒ See drawing/note Volkswagen Golf on page 157

Ⓕ Voir plan/note Volkswagen Golf à la page 157

Ⓓ Siehe Volkswagen Golf Zeichnung/Anmerkung auf Seite 157

Ⓔ Ver dibujo/anotación Volkswagen Golf a la página 157

Ⓖ Ver figura/note Volkswagen Golf na página 157

OIL
GAS

OIL
GAS

VOLKSWAGEN (D)

MULTIVAN T5

	(7H, 7E)	04.03 -			VW038A/GL				VW038P	VW038P/GL		
--	----------	---------	--	--	-----------	--	--	--	--------	-----------	--	--

NEW BEETLE

	(9C1, 1C1)	01.98 -	4		AU018A/GL		100			AU028P/GL		40
	(1Y7)	01.03 -	4		AU018A/GL		100			AU028P/GL		40

PASSAT I

	(32, 33)	05.73 - 09.80		ACC18	AU003A	AU003A/GL		195		VW006P		30
--	----------	---------------	--	-------	--------	-----------	--	-----	--	--------	--	----

PASSAT II

, , excl. Syncro 4X4	(32B)	10.80 - 06.89		ACC19	AU012A	AU012A/GL		195		ACC41	VW014P	VW018P/GL		70
------------------------	-------	---------------	--	-------	--------	-----------	--	-----	--	-------	--------	-----------	--	----

PASSAT III

excl. 2.8 VR6, Syncro 4X4,	(3A2, 35I)	02.88 - 07.91		ACC51	VW018AC	VW018AC/GL		195		ACC68	VW022P	VW022P/GL		60
excl. 2.8 VR6, Syncro,	(3A5, 35I)	02.88 - 07.91	5		VW018A	VW018A/GL								
,	(3A2, 3A5, 35I)	08.91 - 05.97		ACC51	VW018A	VW018A/GL		100		ACC68	VW022P	VW022P/GL		60
excl. 2.8 VR6, Syncro 4X4,			5											
→ Ch. 026435														
,	(3A2, 3A5, 35I)	08.91 - 05.97		ACC51	VW026A	VW026A/GL		100		ACC68	VW022P	VW022P/GL		60
excl. 2.8 VR6, Syncro 4X4,			5											
Ch. 026436 →														
, 2.8 VR6 excl.	(3A2, 3A5, 35I)	08.91 - 08.96		ACC51		VW026A/GL		100		ACC68		VW022P/GL		60
			5											
Syncro 4X4 excl.	(3A2, 35I)	08.88 - 07.91		ACC51	VW018AC	VW018AC/GL		195		ACC68		VW024P/GL		70
Syncro 4X4 excl.	(3A5, 35I)	08.88 - 07.91	5		VW018A	VW018A/GL								
Syncro 4X4 excl.	(3A2, 35I)	08.91 - 08.96		ACC51	VW018A	VW018A/GL		100		ACC68		VW024P/GL		70
→ Ch. 026435			5											
Syncro 4X4 excl.	(3A5, 35I)	08.91 - 12.92		ACC51	VW018A	VW018A/GL		100		ACC68		VW024P/GL		70
→ Ch. 026435			5											
Syncro 4X4 excl.	(3A2, 35I)	01.92 - 08.96		ACC51	VW026A	VW026A/GL		100		ACC68		VW024P/GL		70
Ch. 026436 →			5											

4

- Vedi disegno/nota Volkswagen Golf a pagina 158
- See drawing/note Volkswagen Golf on page 158
- Voir plan/note Volkswagen Golf à la page 158
- Siehe Volkswagen Golf Zeichnung/Anmerkung auf Seite 158
- Ver dibujo/anotación Volkswagen Golf a la página 158
- Ver figura/note Volkswagen Golf na página 158

5

- Vedi disegno/nota Volkswagen Golf a pagina 157
- See drawing/note Volkswagen Golf on page 157
- Voir plan/note Volkswagen Golf à la page 157
- Siehe Volkswagen Golf Zeichnung/Anmerkung auf Seite 157
- Ver dibujo/anotación Volkswagen Golf a la página 157
- Ver figura/note Volkswagen Golf na página 157



		OIL	GAS				OIL	GAS		
--	--	------------	------------	--	--	--	------------	------------	--	--

VOLKSWAGEN (D)

PASSAT IV

1.6, 1.8, 1.8 Turbo, 2.0, 1.9 TDI excl. Syncro 4X4 → Ch. 3B-YE121221	(3B2)	08.96 - 09.99			AU016A/GL		80			AU023P/GL		60
2.3 VR5, 2.8 V6, 2.5 V6 TDI excl. Syncro 4X4 → Ch. 3B-YE121221	(3B2)	08.96 - 09.99			AU021A/GL		80			AU023P/GL		60
1.6, 1.8, 2.0, 1.8 Turbo, 1.9 TDI, 2.3 VR5 Excl. Syncro 4X4 Ch. 3B-YE121222 →	(3B3)	09.99 - 12.05	N.D. H.D.		AU044A/GL		80			AU023P/GL		60
2.5 V6 TDI, 2.8 V6 Excl. Syncro 4X4 Ch. 3B-YE121222 →	(3B3)	09.99 - 12.05			AU045A/GL		80			AU023P/GL		60
1.6, 1.8, 2.0, 1.8 Turbo, 1.9 TDI, 2.3 VR5 Syncro, 4motion 4X4 Ch. 3B-YE121222 →	(3B3)	09.99 - 12.05	N.D. H.D.		AU044A/GL		80			AU024P/GL		
2.5 V6 TDI, 2.8 V6 Syncro, 4motion 4X4 Ch. 3B-YE121222 →	(3B3)	09.99 - 12.05			AU045A/GL		80			AU024P/GL		
1.6, 1.8, 1.8 Turbo, 2.0, 1.9 TDI excl. Syncro 4X4 → Ch. 3B-YE121221	(3B5)	06.97 - 09.99			AU016A/GL		80			AU023P/GL		60
2.3 VR5, 2.8 V6, 2.5 V6 TDI excl. Syncro 4X4 → Ch. 3B-YE121221	(3B5)	06.97 - 09.99			AU021A/GL		80			AU023P/GL		60
1.6, 1.8, 2.0, 1.8 Turbo, 1.9 TDI, 2.3 VR5 Excl. Syncro 4X4 Ch. 3B-YE121222 →	(3B6)	09.99 - 12.05	N.D. H.D.		AU044A/GL		80			AU023P/GL		60
2.5 V6 TDI, 2.8 V6 Excl. Syncro 4X4 Ch. 3B-YE121222 →	(3B6)	09.99 - 12.05			AU045A/GL		80			AU023P/GL		60
1.6, 1.8, 2.0, 1.8 Turbo, 1.9 TDI, 2.3 VR5 Syncro, 4motion 4X4 Ch. 3B-YE121222 →	(3B6)	09.99 - 12.05	N.D. H.D.		AU044A/GL		80			AU024P/GL		
2.5 V6 TDI, 2.8 V6 Syncro, 4motion 4X4 Ch. 3B-YE121222 →	(3B6)	09.99 - 12.05			AU045A/GL		80			AU024P/GL		

PASSAT V

excl.	(3C2)	03.05 -			VW036A/GL					VW036P/GL		
	(3C2)	03.05 -			VW037A/GL					VW037P/GL		

PASSAT CC

excl.		06.08 -			VW036A/GL					VW036P/GL		
incl.		06.08 -			VW037A/GL					VW037P/GL		

PASSAT VI

, excl.	(362, 365)	08.10 -			VW036A/GL					VW036P/GL		
, incl.	(362, 365)	08.10 -			VW037A/GL					VW037P/GL		

OIL
GAS

OIL
GAS

VOLKSWAGEN (D)

POLO I / II

excl. 1.3 G40	(86, 86C, 80)	03.75 - 08.94	ACC18	AU005A	AU005A/GL		155		AU005P	AU005P/GL		
1.3 G40	(86, 86C, 80)	01.87 - 08.94										

POLO III

excl. 1.6 16V GTI	(6N1, 6N2)	09.94 - 06.96	ACC19	VW029A	VW029A/GL		120		VW029P	VW029P/GL		55
excl. 1.6 16V GTI	(6N1, 6N2)	07.96 - 11.01	ACC19	VW029A	VW029A/GL		120		VW029P	VW029P/GL		55
1.6 16V GTI	(6N1, 6N2)	09.94 - 11.01							VW029P	VW029P/GL		55
Classic, Flight	(6KV2)	09.94 - 06.96	ACC19	VW029A	VW029A/GL		120		SE012P	SE012P/GL		55
Classic, Flight	(6KV2)	07.96 - 09.01	ACC19	VW029A	VW029A/GL		120		SE012P	SE012P/GL		55
Variant	(6KV5)	04.97 - 09.01	ACC19	VW029A	VW029A/GL		120		VW032P	VW032P/GL		55
Caddy	(6NF)	10.94 -	ACC19	VW029A	VW029A/GL		120		SE014P			40

- 5**
- Vedi disegno/nota Volkswagen Golf a pagina 157
 - See drawing/note Volkswagen Golf on page 157
 - Voir plan/note Volkswagen Golf à la page 157
 - Siehe Volkswagen Golf Zeichnung/Anmerkung auf Seite 157
 - Ver dibujo/anotación Volkswagen Golf a la página 157
 - Ver figura/note Volkswagen Golf na página 157

POLO IV

1.2, 1.4 16V, 1.4 FSI	(9N)	10.01 - 11.09	3	VW035A	VW035A/GL		110			VW035P/GL		50
1.4 TDI, 1.9 SDI, 1.9 TDI	(9N)	10.01 - 11.09	3	VW035A	VW035A/GL		110			VW035P/GL		50

		Ø 20 mm	Ø 22 mm
		SD003A	AU031A
		SD003A/GL	AU031A/GL
		VW035A	
		VW035A/GL	

POLO V

excl. 2.0 R WRC	(6R)	06.09 -			SE016A/GL					SD016P/GL		100
-----------------	------	---------	--	--	-----------	--	--	--	--	-----------	--	-----

SANTANA

	(32B)	08.81 - 12.84	ACC19	AU012A	AU012A/GL		195	ACC41	VW014P	VW018P/GL		100
--	-------	---------------	-------	--------	-----------	--	-----	-------	--------	-----------	--	-----

OIL
GAS

OIL
GAS

VOLKSWAGEN (D)

SCIROCCO

	(53, 53B)	02.74 - 07.92	ACC19	VW008AC	VW008AC/GL		100	ACC84	VW008P	VW008P/GL		40
excl. 1.8 GT 16 V												
excl. 2.0 R	(137)	09.08 -	6		VW036A/GL					VW036P/GL		
			7		AU038A/GL							
incl. 2.0 R	(137)	09.08 -	6		VW037A/GL					VW037P/GL		
			7		AU039A/GL							

6 7
I Vedi disegno/nota Volkswagen Golf a pagina 159

D Siehe Volkswagen Golf Zeichnung/Anmerkung auf Seite 159

GB See drawing/note Volkswagen Golf on page 159

E Ver dibujo/anotación Volkswagen Golf a la página 159

F Voir plan/note Volkswagen Golf à la page 159

P Ver figura/nota Volkswagen Golf na página 159

SHARAN

	(7M8, 7M9, 7M6)	02.95 - 03.10		FR054A	FR054A/GL		70		FR054P	FR054P/GL		40
	(7N)	05.10 -			VW036A/GL					VW036P/GL		

TARO

4X2		04.89 - 03.97			TY054A/GL		60			NI010P/GL		40
4X4 excl. Extra Cabin		04.89 - 03.97			TY055A/GL		60			TY055P/GL		40
4X4 Extra Cabin		04.89 - 03.97			TY056A/GL		60			TY055P/GL		40

TIGUAN

excl.	(5N)	09.07 -			VW043A/GL					VW043P/GL		
-------	------	---------	--	--	-----------	--	--	--	--	-----------	--	--

TOURAN

excl.	(1T)	02.03 - 05.10			VW042A/GL					VW042P/GL		80
-------	------	---------------	--	--	-----------	--	--	--	--	-----------	--	----

TYPE I (MAGGIOLINO / BEETLE / COCINELLE / KÄFER / KEVER)

1200, 1200 Mexico, 1300, 1500		08.65 - 12.79		VW002A						VW002P/GL		
1302, 1303		01.70 - 07.73	ACC19	VW003A						VW002P/GL		
1303		08.73 - 12.79	ACC19	VW004A						VW002P/GL		

TYPE II TRANSPORTER

		01.55 - 07.67			VW002P/GL					VW002P/GL		
		08.67 - 07.69							VW102P			
		08.69 - 12.79		VW103A			60		VW102P			40
excl. Syncro 4X4		01.80 - 12.90		VW104A			60		VW104P			40

TYPE III 1500 / 1600

1500, 1600	(31)	04.61 - 03.75			VW002P/GL					VW002P/GL		
------------	------	---------------	--	--	-----------	--	--	--	--	-----------	--	--

TYPE IV / CARAVELLE / TRANSPORTER

		09.90 - 12.93		VW107A					VW107P			
		01.94 - 06.03		VW107A					VW107P			

TYPE V / TRANSPORTER

		04.03 -			VW038A/GL				VW038P	VW038P/GL		
--	--	---------	--	--	-----------	--	--	--	--------	-----------	--	--

OIL
GAS

OIL
GAS

VOLKSWAGEN (D)

UP

	12.11 -			VW044A/GL				VW044P/GL	$\frac{1}{6}$	
--	---------	--	--	-----------	--	--	--	-----------	---------------	--

VENTO

excl. 1.8 GT, 2.0, 2.8 VR6, 1.9 TD/TDI → Ch. SW062 538 → Ch. SB019 475	(1H2)	11.91 - 08.94	ACC64 5	VW021A	VW021A/GL		120	ACC68	VW016P	VW016P/GL		60
excl. 1.8 GT, 2.0, 2.8 VR6, 1.9 TD/TDI Ch. SW062 539 → Ch. SB019 476 →	(1H2)	09.94 - 09.98	ACC19 5	VW029A	VW029A/GL		120	ACC68	VW016P	VW016P/GL		60
1.8 GT, 2.0, 1.9 TD/TDI	(1H2)	01.92 - 09.98	ACC51 5		VW028A/GL		120	ACC68		VW019P/GL		60
2.8 VR6	(1H2)	01.92 - 09.98	5		VW028A/GL							

- 5** **I** Vedi disegno/nota Volkswagen Golf a pagina 157 **D** Siehe Volkswagen Golf Zeichnung/Anmerkung auf Seite 157
G See drawing/note Volkswagen Golf on page 157 **E** Ver dibujo/anotación Volkswagen Golf a la página 157
F Voir plan/note Volkswagen Golf à la page 157 **P** Ver figura/note Volkswagen Golf na página 157

VOLVO (S)

140 / 160 SERIES

142, 144, 144 S 145 164	08.66 - 08.74 08.66 - 08.74 08.66 - 08.74		<i>VL001A</i>		$\frac{1}{6}$			<i>VL001P</i>		$\frac{1}{6}$	
-------------------------------	---	--	---------------	--	---------------	--	--	---------------	--	---------------	--

240 / 260 SERIES

excl. Turbo (P242, P244, P262, P264, P265)	08.74 - 08.93	ACC18 1	VL002A			105	2	<i>VL002P</i>		$\frac{1}{6}$	25
2.1 Turbo (P242, P244)	08.80 - 08.93	ACC18 1				105				$\frac{1}{6}$	25
2.1 Turbo (P245)	08.80 - 08.93	1									

- 1** **I** Se le cartucce originali sono a gas, montare l'adattatore Volvo rif. 122 94 23 sotto la cartuccia.
G If the original insert are gas pressurized, place Volvo spacer n° 122 94 23 underneath the insert.
F Si les cartouches d'origine sont à gaz, montez l'adaptateur Volvo Réf. 122 94 23 sous la cartouche.
D Wenn Original-Gasdruckeinsätze montiert sind, Volvo Adapter Nr. 122 94 23 im Federbein unter den Federbeineinsatz montieren.
E Si los cartuchos originales son de gas presurizado, coloque el adaptador Volvo N° 122 94 23 debajo del cartucho.
P Se as aplicações de origem forem a gás, monte o adaptador Volvo ref. 122 94 23 por baixo da aplicação.

- 2** **I** Se il veicolo è munito di correttore d'assetto, sostituire la molla con una Volvo rif. 122 90 52/3/4.
G If the vehicle is equipped with a self levelling suspension, replace the spring by a Volvo one N° 122 90 52/3/4.
F Si le véhicule est équipé d'un correcteur d'assiette, remplacez le ressort par un Volvo Réf 122 90 52/3/4.
D Wenn das Fahrzeug mit automatischem Niveau-Ausgleich-System versehen ist, Originalfeder durch Volvo Feder Nr. 122 90 52/3/4 ersetzen.
E Si el vehículo está equipado con suspensión autonivelada, sustituya el muelle por un muelle Volvo N° 122 90 52/3/4.
P Se o veículo estiver equipado com uma suspensão autonivelável, substitua a mola por uma Volvo ref. 122 90 52/3/4.

300 SERIES

, 343, 345 (343, 345)	02.76 - 12.82	ACC19	<i>VL003A</i>			130		<i>VL003P</i>		$\frac{1}{6}$	50
, 340, 360 (344)	08.82 - 07.91										



		OIL	GAS				OIL	GAS		
--	--	------------	------------	--	--	--	------------	------------	--	--

VOLVO (S)

400 SERIES

	440, 460, 480 1.7 Turbo (445, 464)	08.87 - 12.96		<u>VL009A</u>	VL009A/GL		125		<u>VL009P</u>	VL009P/GL		40
	480 ES excl. B18E eng. → Ch. 520381	04.86 - 12.96										

740

	(744, 745)	08.83 - 04.84	ACC18	<u>VL005A</u>	VL005A/GL		120	3	<u>VL005P</u>	VL005P/GL		25
→ Ch. F0081680												
	(744, 745)	05.84 - 08.92	ACC18	<u>VL006A</u>	VL006A/GL		120	3	<u>VL005P</u>	VL005P/GL		25
Ch. F0081681 →												

760

	(704, 764, 765)	02.82 - 04.84	ACC18	<u>VL005A</u>	VL005A/GL		120	3	<u>VL005P</u>	VL005P/GL		25
→ Ch. F0081680												
	(704, 764, 765)	05.84 - 08.87	ACC18	<u>VL006A</u>	VL006A/GL		120	3	<u>VL005P</u>	VL005P/GL		25
Ch. F0081681 →												
	(704, 764)	09.87 - 07.92	ACC18	<u>VL006A</u>	VL006A/GL		120	MultiLink				
	(704, 765)	05.84 - 07.92	ACC18	<u>VL006A</u>	VL006A/GL		120	3	<u>VL005P</u>	VL005P/GL		25
Ch. F0081681 →												

780

		01.85 - 08.87	ACC18	<u>VL006A</u>	VL006A/GL		120	3	<u>VL005P</u>	VL005P/GL		25
		09.87 - 07.90	ACC18	<u>VL006A</u>	VL006A/GL		120	MultiLink				

- 3** **I** Se il veicolo è munito di correttore d'assetto, sostituire la molla con una Volvo rif. 135 97 10 o 127 39 77.
- GB** If the vehicle is equipped with a self levelling suspension, replace the spring by a Volvo one N° 135 97 10 or 127 39 77.
- F** Si le véhicule est équipé d'un correcteur d'assiette, remplacez le ressort par un Volvo Réf 135 97 10 ou 127 39 77.
- D** Wenn das Fahrzeug mit automatischem Niveau-Ausgleich-System versehen ist, Originalfeder durch Volvo Feder Nr. 135 97 10 oder 127 39 77 ersetzen.
- E** Si el vehículo está equipado con suspensión autonivelada, sustituya el muelle por un muelle Volvo N° 135 97 10 ó 127 39 77.
- P** Se o veículo estiver equipado com uma suspensão autonivelável, substitua a mola por uma Volvo ref. 135 97 10 ou 127 39 77.

850

	excl. 2.3 T5,	(LS, LW)	06.91 - 12.96	4		VL014A/GL		100	excl.		VL014P/GL		50
→ Ch. 1744999													
	excl. 2.3 T5,	(LS, LW)	06.91 - 12.96	5		VL014A/GL		100	excl.		VL014P/GL		50
Ch. 1745000 →													

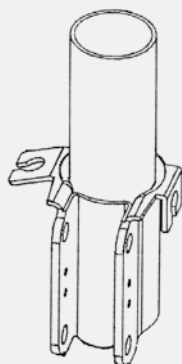
4

VL014A/GL

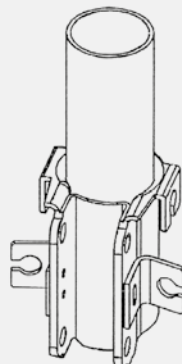
5

VL014A/GL

OIL
GAS

OIL
GAS

VOLVO (S)

940

, excl. Turbo	(944, 945)	08.90 - 10.98		ACC18	VL006A/GL		120			VL005P/GL		25
, Turbo	(944, 945)	08.90 - 10.98		ACC18	VL006A/GL		120					

960

→ Ch. YV1964...R.048299	(964)	08.90 - 09.94		ACC18	VL006A/GL		120	MultiLink				
Ch. YV1964...R.048300 →	(964)	09.94 - 12.96			VL024A/GL					VL024P/GL		
→ Ch. YV1965...R.018099	(965)	08.90 - 09.94			VL006A/GL		120			VL005P/GL		
Ch. YV1965...R.018100 →	(965)	09.94 - 12.96			VL024A/GL					VL026P/GL		

- 3** Se il veicolo è munito di correttore d'assetto, sostituire la molla con una Volvo rif. 135 97 10 o 127 39 77.
- If the vehicle is equipped with a self levelling suspension, replace the spring by a Volvo one N° 135 97 10 or 127 39 77.
- Si le véhicule est équipé d'un correcteur d'assiette, remplacez le ressort par un Volvo Réf 135 97 10 ou 127 39 77.
- Wenn das Fahrzeug mit automatischem Niveau-Ausgleich-System versehen ist, Originalfeder durch Volvo Feder Nr. 135 97 10 oder 127 39 77 ersetzen.
- Si el vehículo está equipado con suspensión autonivelada, sustituya el muelle por un muelle Volvo N° 135 97 10 ó 127 39 77.
- Se o veículo estiver equipado com uma suspensão autonivelável, substitua a mola por uma Volvo ref. 135 97 10 ou 127 39 77.

C30

	10.06 - 12.12			VL025AS/GL						VL025P/GL		
				VL025AD/GL								

C70 II

	03.06 -			VL025AS/GL						VL025P/GL		
				VL025AD/GL								

S40 / V40

excl. ,	(VS, VW)	05.95 - 05.99			VL017AS/GL		70	excl.		VL017P/GL		80
excl.	(VS, VW)	05.95 - 05.99			VL022AS/GL		70	excl.		VL019P/GL		80
excl.	(VS, VW)	06.99 - 04.00			VL018AS/GL		70	excl.		VL017P/GL		80
excl. T4	(VS, VW)	06.99 - 04.00			VL018AD/GL		70	Nivomat				
, 1.9 T4	(VS, VW)	05.97 - 07.00			VL019AS/GL		70	excl.		VL019P/GL		80
excl. 2.0 T4	(VS, VW)	04.00 - 12.03			VL020AS/GL		70	excl.		VL020P/GL		80
excl. ,	(VS, VW)	04.00 - 12.03			VL021AS/GL		70	Nivomat				
, 2.0 T4	(VS, VW)	08.00 - 12.03			VL021AS/GL		70	excl.		VL021P/GL		80
excl.	(VS, VW)	08.00 - 12.03			VL021AD/GL		70					

OIL
GAS

OIL
GAS

VOLVO (S)

S40 / V50

S40 V50 excl. 4X4	(MS, MW)	01.04 - 04.04 -	 		VL025AS/GL VL025AD/GL	 			VL025P/GL	$\frac{1}{0}$	
-------------------------	----------	--------------------	------	--	--------------------------	------	--	--	-----------	---------------	--

S60

excl. 4X4,		11.00 - 04.10			VL023A/GL		70	excl.	VL023P/GL	$\frac{1}{0}$	60
------------	--	---------------	--	--	-----------	--	----	-------	-----------	---------------	----

S60 II

excl.		04.10 -	 		VL028AS/GL VL028AD/GL	 			VL028P/GL	$\frac{1}{0}$	
-------	--	---------	------	--	--------------------------	------	--	--	-----------	---------------	--

S70 / V70 / C70

S70 excl. 2.3 T5 C70	(LS)	01.97 - 08.00 01.97 - 08.00	S		VL014A/GL		100	excl.	VL014P/GL	$\frac{1}{0}$	50
V70 excl. 2.3 T5	(LV)	01.97 - 02.00	S		VL014A/GL		100	excl.	VL014P/GL	$\frac{1}{0}$	50
V70 excl. 4X4,	(LV)	03.00 -			VL023A/GL		100	excl.	VL023P/GL	$\frac{1}{0}$	50

S
I Vedi disegno/nota Volvo 850 a pagina 165

GB See drawing/note Volvo 850 on page 165

F Voir plan/note Volvo 850 à la page 165

D Siehe Volvo 850 Zeichnung/Anmerkung auf Seite 165

E Ver dibujo/anotación Volvo 850 a la página 165

P Ver figura/note Volvo 850 na página 165

S80

excl.	(TS, XY)	05.98 -			VL023A/GL		70	excl.	VL023P/GL	$\frac{1}{0}$	90
-------	----------	---------	--	--	-----------	--	----	-------	-----------	---------------	----

S80 II

excl.	(AS)	03.06 -	 		VL028AS/GL VL028AD/GL	 			VL028P/GL	$\frac{1}{0}$	
-------	------	---------	------	--	--------------------------	------	--	--	-----------	---------------	--

S90

 excl.		01.97 - 05.98			VL024A/GL				VL024P/GL	$\frac{0}{0}$	25
-----------	--	---------------	--	--	-----------	--	--	--	-----------	---------------	----

V60

excl.		04.10 -	 		VL028AS/GL VL028AD/GL	 			VL028P/GL	$\frac{1}{0}$	
-------	--	---------	------	--	--------------------------	------	--	--	-----------	---------------	--

V70 III

excl. 4x4, excl.	(BW)	08.07 -	 		VL028AS/GL VL028AD/GL	 			VL028P/GL	$\frac{1}{0}$	
------------------	------	---------	------	--	--------------------------	------	--	--	-----------	---------------	--

V90

 excl.		01.97 - 12.98			VL024A/GL				VL026P/GL	$\frac{0}{0}$	25
-----------	--	---------------	--	--	-----------	--	--	--	-----------	---------------	----

XC60

excl.	(AS)	05.08 -	 		VL029AS/GL VL029AD/GL	 				$\frac{0}{0}$	
-------	------	---------	------	--	--------------------------	------	--	--	--	---------------	--

ORDINI: Gli ordini devono pervenire presso la nostra sede a mezzo fax o posta elettronica. Solo in via del tutto eccezionale possono essere accettati ordini verbali, in tal caso si declina ogni responsabilità per inesattezze, incomprensioni o interpretazioni errate. Tutti gli ordini sono subordinati all'approvazione da parte dell'azienda che si riserva la facoltà di accettarli.

PREZZI: Per tutti gli ammortizzatori a catalogo fanno fede i prezzi indicati sul listino in vigore. Tutti i prezzi si intendono IVA esclusa e franco nostro stabilimento. L'azienda si riserva la facoltà di modificare i prezzi convenuti senza obbligo di preavviso. Invitiamo la gentile clientela a verificare tutte le condizioni indicate nella conferma d'ordine.

CONSEGNE: Tutti i termini di consegna del materiale ordinato, anche se indicati nella conferma d'ordine, sono da considerarsi indicativi e non impegnativi per l'azienda. I ritardi o le mancate consegne del materiale eventualmente non disponibile presso i nostri magazzini non potranno dare consenso all'annullamento dell'ordine in corso, né potranno costituire pretesto per risarcimento di danni. Eventuali deroghe alle presenti condizioni di consegna devono essere concordate ed accettate per iscritto da entrambe le parti.

CONFEZIONAMENTO: Tutto il materiale verrà consegnato adeguatamente confezionato, secondo gli standard previsti dall'azienda. Eventuali variazioni in questo senso devono essere concordate con l'ufficio commerciale e regolamentate per iscritto. Le spese di confezionamento si intendono comprese nel prezzo degli ammortizzatori.

IMBALLO: L'imballo verrà effettuato secondo gli standard in uso e fatturato al costo. Eventuali variazioni in tal senso devono essere preventivamente concordate per iscritto da entrambe le parti.

SPEDIZIONE: La merce viaggia sempre a rischio e pericolo del committente, anche se spedita in porto franco. In mancanza di precise indicazioni del committente tutto il materiale verrà spedito con il mezzo ritenuto più opportuno. La nostra responsabilità, per tutto il materiale spedito, si conclude alla consegna del medesimo al vettore. Eventuali danni, furti, manomissioni o quant'altro possa arrecare inconvenienti al committente vanno gestiti direttamente dallo stesso con il trasportatore. Il destinatario rimane comunque vincolato al pagamento totale della merce spedita. L'azienda non risponde per eventuali ritardi nelle consegne derivanti da cause di forza maggiore o da circostanze dipendenti dal vettore.

RECLAMI: Eventuali reclami, dovuti a discordanze riscontrate nella documentazione, o di qualsiasi altra natura, devono essere notificati entro e non oltre 8 giorni dalla data di ricevimento del materiale a mezzo lettera raccomandata. Fanno eccezione tutti i reclami considerati motivo di garanzia per i quali rimandiamo alla sezione "garanzia del prodotto".

PAGAMENTI: Il pagamento delle fatture deve essere fatto entro il termine prescritto ed indicato in fattura. Il mancato rispetto dei termini di pagamento comporterà l'addebito delle spese di insoluto e degli interessi di mora, calcolati in base al tasso EURIBOR maggiorato di 6 punti; renderà inoltre le altre fatture in corso, ancorché non scadute, immediatamente esigibili. Il mancato pagamento autorizza pure l'azienda a sospendere tutte le forniture con effetto immediato. I pagamenti sono validi solo se effettuati, direttamente all'azienda o a persona da noi espressamente autorizzata, secondo le disposizioni concordate con il nostro ufficio amministrativo.

CONTROVERSIE: Per qualsiasi controversia, nessuna esclusa, sarà competente il Foro di Treviso.

TUTELA DELLA PRIVACY: Tutti i dati relativi al committente, ivi compresi quelli inerenti gli ordinativi e le condizioni in uso, saranno custoditi ed elaborati, anche con sistemi informatici, per soli scopi statistici, adempimenti fiscali e di legge e per l'invio di materiale informativo o promozionale, secondo quanto stabilito dalla legge 675/96 e D.L. 196/2003 in materia.

Tutte le condizioni riportate, ivi incluse quelle seguenti, relative alla garanzia del prodotto, si ritengono accettate integralmente al momento del ricevimento dell'ordine, sia esso scritto o verbale.

GARANZIA DEL PRODOTTO

L'intera gamma **WKATORY** è offerta con una garanzia di due anni. Tale garanzia si ritiene subordinata alle condizioni, elencate di seguito, che l'acquirente è tenuto a verificare e rispettare durante l'intero periodo garantito.

CONDIZIONI DI GARANZIA: La garanzia di due anni applicata a tutti gli ammortizzatori copre esclusivamente le non conformità, verificate sugli ammortizzatori stessi, relativamente a vizi di fabbricazione e di funzionamento.

La garanzia del prodotto, in quanto tale, vale esclusivamente nei termini di sostituzione gratuita del materiale riconosciuto difettoso.

Tale garanzia inoltre si ritiene valida per il solo prodotto riconosciuto non conforme, pertanto non prevede estensioni a coppie o insiemi di ammortizzatori, anche se installati sul medesimo veicolo.

Non sussistono risarcimenti, o pretese di qualsiasi natura, ulteriori a quelle precedentemente esposte; anche qualora direttamente o indirettamente collegate alla non conformità del prodotto.

La garanzia non comprende :

- La normale usura dell'ammortizzatore.
- I danni derivanti da incidenti, di qualsivoglia natura, subiti dal veicolo.
- I danni provocati all'ammortizzatore da un montaggio scorretto o dall'impiego di attrezzature non idonee (es. stelo rovinato dalle pinze).
- I danni provocati dall'utilizzo dell'ammortizzatore su veicoli diversi da quelli per i quali è stato realizzato, in conformità a quanto riportato sullo stesso catalogo corrente.
- I danni causati da manomissioni di qualsiasi natura apportate all'ammortizzatore.
- Le non conformità dovute all'impiego dell'ammortizzatore su sistemi di sospensione speciali per i quali non è previsto il suo impiego (sospensioni autolivellanti, sospensioni regolabili elettronicamente, ecc.).
- I danni arrecati all'ammortizzatore dall'utilizzo del veicolo in competizioni automobilistiche di qualsiasi natura.
- I danni causati all'ammortizzatore dal montaggio su sospensioni con caratteristiche e componenti diversi dall'originale, quali ad esempio molle tagliate, tamponi e parapolvere modificati o eliminati, ecc.
- Eventuali montaggi abbinati a molle di assetto sportivo, eccezion fatta per le molle di assetto di nostra produzione e per i pacchetti sportivi forniti dalla casa produttrice.
- I danni arrecati da manutenzione scorretta o insufficiente del mezzo.

RICHIESTA DI GARANZIA: La richiesta di garanzia del prodotto deve essere presentata al concessionario presso il quale è stato acquistato. Il concessionario stesso provvederà direttamente, dopo l'accertamento della non conformità, alla sostituzione del materiale difettoso. Al concessionario dovranno essere consegnati tutti i dati indispensabili alla verifica della garanzia, e più precisamente :

- Estremi dell'acquirente o dell'officina di montaggio.
- Codice dell'articolo non conforme.
- Quantità non conforme.
- Data di acquisto e di montaggio.
- Dati di riconoscimento del veicolo.
- Condizione del veicolo al momento del montaggio.
- Descrizione dettagliata della non conformità.

Il concessionario successivamente avrà cura di trasmettere i suddetti dati all'ufficio di Controllo Qualità del produttore il quale avvierà il processo di verifica. Dopo l'acquisizione dei dati forniti dal cliente verrà data l'autorizzazione al reso del materiale difettoso.

Il prodotto ritenuto non conforme dovrà quindi pervenire presso di noi, in porto franco, corredato di documento in conto garanzia (qualora il materiale non fosse spedito dal distributore la bolla dovrà recare come intestatario il distributore stesso). Sarà respinto tutto il materiale spedito senza il benestare a procedere da parte dell'azienda.

Il ripristino, la sostituzione o l'accredito del prodotto in garanzia sarà fatto solo dopo l'accertamento della non conformità da parte del personale tecnico addetto al controllo qualità, nel rispetto delle condizioni sopra elencate. Lo stesso personale sarà a disposizione del cliente per ogni chiarimento in merito.

La possibilità di sostituzione immediata del materiale ritenuto non conforme, al fine di evitare il fermo del veicolo, è prerogativa esclusiva del distributore, il quale può eventualmente adottarla a sua discrezione, rimanendo tuttavia non vincolata alle condizioni generali di garanzia del prodotto.

Per conoscenza segnaliamo che tutti i reclami ed i certificati di garanzia verranno archiviati, unitamente ai dati a nostra disposizione (cliente, non conformità, riferimenti produttivi, ecc.), per disporne in qualunque momento e per verificare l'utilità di azioni correttive eventualmente necessarie su alcuni prodotti.

Tutti i dati dei clienti verranno comunque custoditi ed elaborati esclusivamente per attività informatiche e di ricerca interne all'azienda, adempimenti di legge ed eventuale invio di materiale informativo-promozionale; in conformità a quanto richiesto dalla legge 675/96 e D.L. 196/2003 sulla tutela della privacy.

PURCHASE ORDERS: Orders must be forwarded to our offices by fax or e-mail. Verbal orders will be accepted only in very special conditions, in which case we shall not be held responsible for inexactness, misunderstandings or erroneous interpretation.

Orders are subject to approval by our offices who reserves the right to accept them.

PRICES: For all shock absorbers in our catalogue the prices applied are those contained in the current up to date price-lists.

All prices do not include VAT and are for goods available ex works.

We reserve the right to make changes to the prices agreed without notice. We therefore invite customers to check all conditions at the time of our order confirmation.

DELIVERY: All delivery times provided for the goods that have been ordered, even when stated in our order confirmation, should be considered approximate and are not binding to the supplier.

Any delays or failure to deliver any goods not currently available in our warehouses shall not entitle cancellation of the order in progress and give grounds for an indemnification claim.

Any variation to these delivery terms shall be agreed and accepted in writing by both parties.

PACKAGING: All goods are delivered suitably packed, according to our company's standards.

Any variations shall be agreed with our sales department and made in writing.

The cost of packaging is included in the price of the shock absorber.

PACKING: Goods are packed by our company according to our standards and invoiced according to cost.

Any variations shall be agreed writing by both parties.

DELIVERY: Goods travel always at the customer's own risk, even when delivered duty paid.

Unless specifically stated by the customer, the goods will be delivered with the means of transport we consider most appropriate.

Our liability regarding all the goods dispatched ends upon their delivery to the forwarding agent.

Any damage, theft, tampering with or any other inconveniences caused to the customer shall be handled by the latter with the forwarding agent.

The consignee shall always pay the total amount of the goods delivered.

We shall not be held responsible for any delays due to circumstances beyond our control and/or natural calamities, or other circumstances depending on the forwarding agent.

COMPLAINTS: Any complaints due to discrepancies in the documents or of any other kind, shall be notified by registered letter no later than 8 days after receipt of the goods.

This clause does not apply in the case of complaints considered warranty conditions regarding this please see the "Product warranty" section.

PAYMENTS: Invoices shall be paid within the prescribed term stated in the invoice.

Non-compliance with the terms of payment shall cause any unsettled payment expenses to be charged interest for delayed payment, calculated according to the EURIBOR rate plus 6% and due for immediate payment even if not overdue.

Any failure to settle payments authorises us to suspend all deliveries immediately.

Payments are valid only when made directly to our company or to any person authorised by the company in agreement with our administration.

DISPUTES: Disputes of any kind shall be submitted to the jurisdiction of the Court of Treviso.

PRIVACY: All data concerning customers, including any information concerning orders and terms applied, shall be stored and processed, even electronically solely for statistical purposes, for legal or fiscal requirements and for dispatching informative or promotional material as prescribed by the relevant Italian Law on Privacy.

PRODUCT WARRANTY

Our whole range of **WKTORY** is offered with a two-year warranty.

The warranty is subject to the conditions stated below that the purchaser must check and respect for the entire warranty period.

WARRANTY CONDITIONS: The two-year warranty is applied to shock absorbers in the "improved" range and covers exclusively non-compliance assessed on the shock absorbers due to manufacturing or working defects.

Our product warranty is applied exclusively in terms of free of charge replacement goods acknowledged as being faulty.

In addition, the warranty applies in the case of a single product acknowledged as non-confirming and therefore cannot be extended to pairs or multiple shock absorbers, even when they are installed on the same vehicle.

No compensation or claims of any kind besides those aforementioned are acceptable even when directly or indirectly related to the non-conforming component.

The warranty does not include:

- Normal wear and tear of shock absorbers
- Damage caused by accidents of any kind involving the vehicle.
- Damage caused to the shock absorber by improper installation or by the use of unsuitable equipment (e.g. piston rod ruined by pincers).
- Damage caused by using the shock absorber on a vehicle other than the model the shock absorber has been made for as mentioned in our current catalogue.
- Damage caused by any kind of tampering with the shock absorber.
- Non-compliance due to the use of the shock absorber in special suspension systems to which it is not suited (self-levelling suspensions, electronically adjustable suspension, etc.).
- Damage caused to the shock absorber by the use of the vehicle in any kind of car competitions.
- Damage caused to the shock absorber by installation on suspension using features and components differing from the original, such as cut springs, modified or eliminated rebound bumpers and dust covers, etc.
- Any installation combined with sports springs, apart from our own series and from original sports kits supplied by the manufacturer.
- Damage due to improper or insufficient maintenance of the vehicle.

WARRANTY REQUEST: The product warranty request must be forwarded to the dealer where it has been purchased.

After assessing non-compliance the dealer shall replace the faulty goods immediately.

It is necessary to provide the dealer with all the information needed to check the warranty, i.e.:

- Customer or installation shop details.
- Non-conforming article part number.
- Non-conforming quantity.
- Date of purchase and installation.
- Vehicle identification data.
- Vehicle conditions at the time of installation.
- Detailed description of non-compliance.

The dealer shall then communicate the information above to the manufacturer's Quality Control Service, which initiates the control process.

On receipt of the information provided by the customer the return of the faulty goods will be authorised.

Any products considered non-conforming shall therefore be returned to us carriage paid together with a warranty delivery note (if the goods are not returned via the distributor the delivery note shall be sent with the distributor as consignee).

Any goods returned without our approval shall be rejected.

The repair, replacement of our credit note for the product under warranty shall occur only once non-compliance has been assessed by our quality control technicians in the full respect of the above-mentioned conditions.

Our staff is at customer's disposal for any explanations regarding these matters.

The possibility of immediate replacement the goods considered non-conforming in prevent stopping the vehicle, depends exclusively on the distributor who proceed at his own discretion, remaining however not bound by the product general warranty conditions. We inform you that all complaints and warranty certificates will be filed together with the information available to us (customer, non-compliance, production references, etc.) so that we can use them at any time and to assess the utility of any corrective actions required for products.

All customer data will be filed and processed only for internal information and research activities, legal or fiscal requirements and dispatch of informative and promotional material in compliance with the Italian Law concerning the safeguard of privacy.

All the aforesaid conditions are considered accepted in full upon receipt of a written or verbal order.

PARAOLIO SCOPPIATO

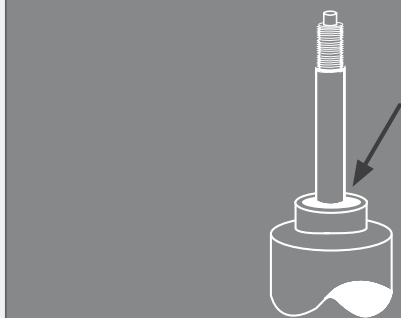

Ammortizzatore che presenta una slabbratura della guarnizione di tenuta con conseguente perdita di olio e quindi rottura dell'ammortizzatore, dovuta alla NON sostituzione del tampone di fine corsa deteriorato e quindi al non rispetto del suo corretto funzionamento come assorbitore d'urti.

A shock absorber with burring on the gasket and consequent oil leak, which would lead to the shock absorber breaking. This is caused by failure to replace the worn rubber rebound bumper, which is unable to absorb any impact.

SFONDAMENTO DI FINECORSA

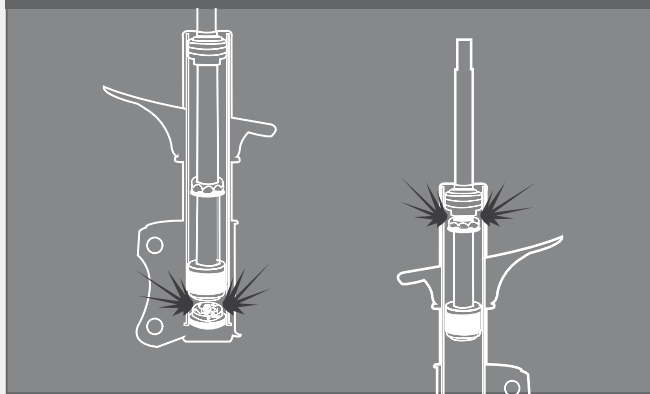

Sfondamento della valvola di fondo dell'ammortizzatore e del pistone a causa del continuo lavoro a fine corsa inferiore dell'ammortizzatore causato da percorrenza in strade dissestate e da continui dossi rompi velocità con conseguente deterioramento del tampone di fine corsa e del cedimento progressivo della molla di sospensione. Risultato perdita olio, effetto elastico e non funzionamento dell'ammortizzatore.

A smashed bottom valve and piston due to continued working of the shock absorber at the bottom, caused by uneven road surfaces or speed humps, which damage the rubber rebound bumper and gradually cause the suspension spring to give way. The result is leaking oil, reduced elastic effect and ineffective shock absorber.



PRINCIPALI CAUSE DI DANNEGGIAMENTO NON IMPUTABILI A DIFETTOSITÀ DEL PRODOTTO

PRINCIPLE DEFECTS DUE TO IMPROPER HANDLING OF PRODCUT

ROTTURA TAMPONE DI FINECORSA

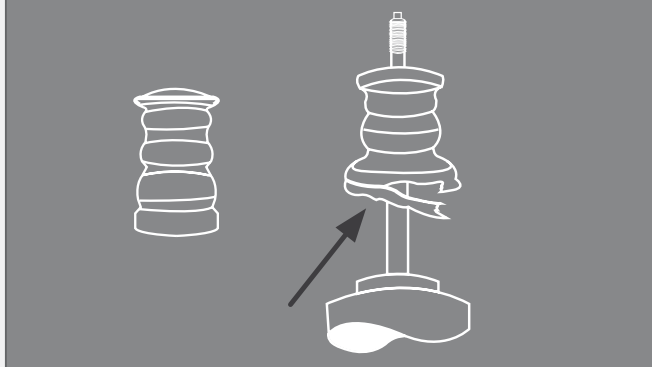

Ammortizzatore danneggiato per usura del tampone di fine corsa, dove soprattutto con il nuovo e massiccio impiego da parte dei costruttori del poliuretano microcellulare che evita in parte anche il sovraccarico del mezzo, il tampone si deteriora rapidamente sia come sfrangiatura che come rigidità con conseguente rottura dell'ammortizzatore per urti di fine corsa inferiore.

A shock absorber damaged by a worn rubber rebound bumper due to the massive use by manufacturers of microcell polyurethane to make the bumpers, which avoid part of the shock absorber overload. With excessive work the bumper deteriorates, disintegrates and becomes hard, and therefore the shock absorber breaks due to closing impact.

ROTTURA OCCHIELLI E PERNI

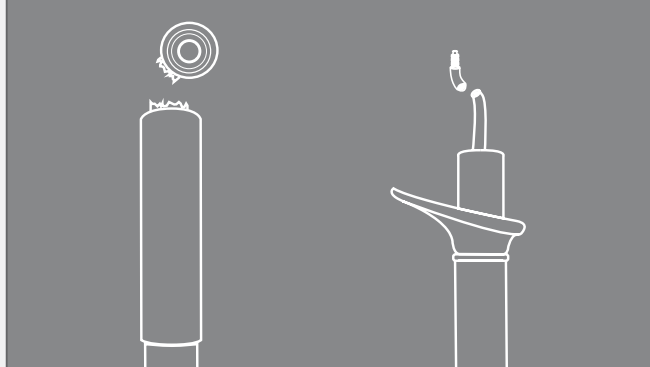

Ammortizzatore che presenta il distacco dell'occhiello (o del perno) dovuto ad un urto, o nel caso del perno, al non corretto montaggio con il giusto serraggio di coppia eseguito con le attrezzature non corrette, utilizzando la pistola pneumatica anziché la chiave dinamometrica. Il distacco dell'occhiello può avvenire anche nel caso in cui il fissaggio dell'ammortizzatore sia stato fatto ancora a veicolo sollevato, anziché con le ruote appoggiate al terreno e quindi con l'ammortizzatore nella corretta posizione di lavoro.

A shock absorber with a broken grommet (or pin), caused by a collision or incorrectly mounting the pin using the wrong tools (e.g. pneumatic screwdriver instead of a torque wrench). The grommet could also detach when the shock absorber has been mounted with the vehicle lifted off the ground and not with the wheels on the ground, which is the correct position to work the shock absorber.

FILETTATURA ROVINATA

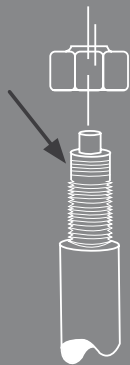

Ammortizzatore che presenta il filetto rovinato, in quanto nel montaggio non è stato utilizzato il KIT di viti corredato, bensì un dado di passo diverso da quello fornito, e soprattutto perché si è utilizzato la pistola pneumatica e non invece la chiave dinamometrica.

A shock absorber with ruined thread, due to being mounted without using the supplied screws, but just a nut with a different pitch to the one supplied. Using a pneumatic screwdriver instead of a torque wrench can also cause this damage.

AMMORTIZZATORE STORTO

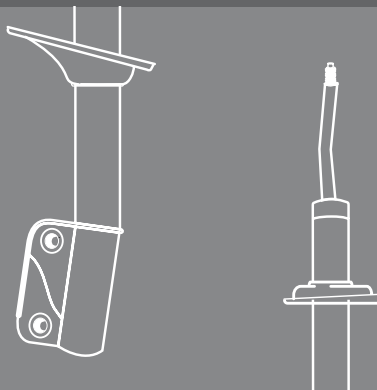

Ammortizzatore che si presenta piegato, o solo con l'albero storto, oppure il corpo piegato; normalmente questo avviene nel caso dell'albero storto, quando il veicolo urta uno scalino nella strada, mentre la piegatura del corpo dell'ammortizzatore nel caso di incidente più o meno marcato.

A shock absorber with twisted bracket, body or pin. If the piston is twisted it is normally due to impact with a kerb, while a twisted body is caused by a more serious accident.

FORI ATTACCO MODIFICATI

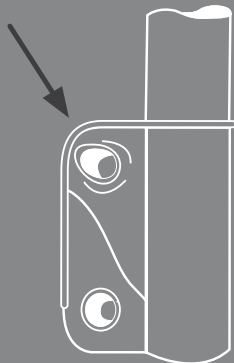

Ammortizzatore che presenta una allargatura manuale del foro di attacco al mozzo ruota in fase di controllo della geometria del veicolo, dovuto principalmente a fattori accidentali che il veicolo ha subito sulla strada, come incidenti e urti vari con conseguente spostamento degli assi di camber.

The shock absorber has a manual widening of the wheel hub attachment hole during alignment, which is caused by road accidents that cause the camber axle to move.

STELO ROVINATO E ARRUGGINITO

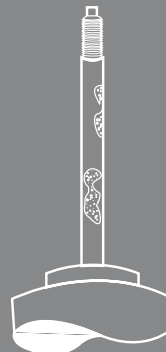

Superficie cromata dello stelo rovinata da ammaccature, botte e ruggine con conseguente perdita di olio attraverso il paraolio, difetto questo dovuto nella fase di montaggio dal non corretto fissaggio e protezione del soffietto parapolvere e del tampone di fine corsa.

The piston rod chrome-plated surface is ruined by dents, knocks and rust, with oil leaking through the oil retainer. This fault is caused by incorrectly mounting the rubber rebound bumper and the dust cover.

ALBERO ROVINATO CON LA PINZA

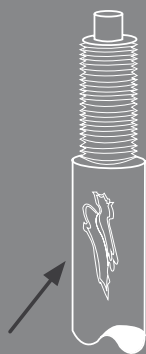

Ammortizzatore che presenta l'albero cromato con evidenti segni di graffiatura della superficie cromata, con conseguente perdita di olio e gas ogni qual volta la parte danneggiata entra nella guarnizione a tenuta di gomma. Danno causato dal non corretto impiego di utensili idonei al montaggio degli ammortizzatori.

A shock absorber with clear signs of scratching on the chrome plated surface of the piston rod, causing oil and gas leaks each time the damaged part enters the gasket. Damage caused by using incorrect tools to mount the shock absorber.

ALBERO USURATO



Ammortizzatore che presenta l'albero cromato danneggiato solo da un lato con evidente zona ovale arrugginita o quantomeno molto lucida e quindi consumata rispetto al resto della cromatura. Pistone quindi sottoposto ad un grosso carico laterale dovuto al non corretto serraggio con ruote a terra e soprattutto al non corretto camber del veicolo.

A shock absorber with the piston rod damaged on just one side, with a clear rusty or shiny oval patch and extensive wear with respect to the rest. The piston rod is subject to heavy side load, caused by incorrect mounting of the wheels on the ground and incorrect alignment.

ATTACCHI AMMORTIZZATORI

Shock absorbers end fitting - Type des fixations des amortisseurs - Befestigung der Stossdämpfer
 Esquema de anclajes - Diagrama de Montagem de Amortecedores - Bevestigingstype van de schokdemper - Monterings vejledning - Крепления амортизаторов
 ingstype van de schokdemper - Monterings vejledning - Крепления амортизаторов



- Tipo di applicazione

- Application type
- Type de application
- Anwendung der Stossdämpfer
- Esquema de anclajes
- Esquema de Montagem
- Bevestiging van de schokdemper
- Anvendelse
- Вид применения



- Sospensione MacPherson

- Complete MacPherson strut
- Jambe de force type MacPherson
- MacPherson komplettes Federbein
- Columna de suspension
- Coluna de Suspensão MacPherson
- Complete MacPherson veerpoet
- Komplet fjederben
- Подвеска Макферсона



- Cartuccia di ricambio MacPherson

- MacPherson insert
- Cartouche type MacPherson
- MacPherson Federbeinsatz
- Cartucho accesorio para columna de suspensión
- Cartucho Substituição para Coluna Suspensão MacPherson
- MacPherson patroon
- Inlets
- Заменяемый вкладыш стойки Макферсона



- Ammortizzatore con piattello portamolla

- Shock absorber with spring seat
- Amortisseur à siège de ressort
- Stossdämpfer mit Federsitzsteller
- Amortiguador con asiento para muelle
- Amortecedor com Base para Mola
- Schokdemper met veerschotel
- Støddæmper med fjeder skål
- Амортизатор с площадкой для установки пружины



- Tempo di montaggio (min) per asse

- Assembly time (min.) for the axle
- Temps de montage (min.) pour axe
- Montagezeit (Min.) jeder Achse
- Tiempo de montaje (Min.) para eje
- Tempo de Montagem (Min.) por Eixo
- Werkijd (Min.) per as
- Monterings tid (min) per aksel
- Время монтажа (минут) на мост

Occhio
Eyering
Oeil
Auge
Anilha
Anilha
Oog
Øje
Отверстие

Occhio
Eyering
Oeil
Auge
Anilha
Anilha
Oog
Øje
Отверстие

Perno
Stud
Tige
Stift
Esparràgo
Parafuso
Stift
Stift
Шток

Silentblock
Barpin
Barrette
Brücke
Pasador
Sinobloco
Pin
Silentblock
Втулка

Speciale
Special
Spécial
Besondere
Especial
Especial
Special
Special
Специальная

Occhio
Eyering
Oeil
Auge
Anilha
Anilha
Oog
Øje
Отверстие

Perno
Stud
Tige
Stift
Esparràgo
Parafuso
Stift
Stift
Шток

Occhio
Eyering
Oeil
Auge
Anilha
Anilha
Oog
Øje
Отверстие

Perno
Stud
Tige
Stift
Esparràgo
Parafuso
Stift
Stift
Шток

Silentblock
Barpin
Barrette
Brücke
Pasador
Sinobloco
Pin
Silentblock
Втулка

Speciale
Special
Spécial
Besondere
Especial
Especial
Special
Special
Специальная

Silentblock
Barpin
Barrette
Brücke
Pasador
Sinobloco
Pin
Silentblock
Втулка

Perno
Stud
Tige
Stift
Esparràgo
Parafuso
Stift
Stift
Шток

Silentblock
Barpin
Barrette
Brücke
Pasador
Sinobloco
Pin
Silentblock
Втулка

Silentblock
Barpin
Barrette
Brücke
Pasador
Sinobloco
Pin
Silentblock
Втулка

Occhio
Eyering
Oeil
Auge
Anilha
Anilha
Oog
Øje
Отверстие

Silentblock
Barpin
Barrette
Brücke
Pasador
Sinobloco
Pin
Silentblock
Втулка

Perno
Stud
Tige
Stift
Esparràgo
Parafuso
Stift
Stift
Шток

Speciale
Special
Spécial
Besondere
Especial
Especial
Special
Special
Специальная



Silentblock
Barpin
Barrette
Brücke
Pasador
Sinobloco
Pin
Silentblock
Втулка





















Perno
Stud
Tige
Stift
Esparràgo
Parafuso
Stift
Stift
Шток



















Occhio
Eyering
Oeil
Auge
Anilha
Anilha
Oog
Øje
Отверстие

Occhio
Eyering
Oeil
Auge
Anilha
Anilha
Oog
Øje
Отверстие

Silentblock
Barpin
Barrette
Brücke
Pasador
Sinobloco
Pin
Silentblock
Втулка

									
	Tutti i modelli	All models	Tous modèles	Alle Modelle	Todos los modelos	Todos os modelos	Alle modellen	Alle modeller	Все модели
	Berlina 4 porte	Saloon 4 doors	Berline 4 portes	Limousine 4 Türen	Berlina 4 puertas	Berlina 4 portas	Berline 4-deurs	Sedan 4 Døre	Седан 4-х дверный
	Berlina 3-5 porte	Hatchback - Fastback	Berline 3-5 portes	Limousine 3-5 Türen	Berlina 3-5 puertas	Berlina 3-5 portas	Berline 3-5 deurs	Sedan 3-5 Døre	Седан 3-5 дверный
	Station wagon - Familiare	Estate - Station wagon	Break	Kombi - Variant	Familiar	Familiar - Station Wagon	Stationcar	Stationcar	Универсал
	Coupé	Coupé	Coupé	Coupé	Coupé	Coupé	Coupé	Coupe	Купе
	Cabriolet - Spider	Cabriolet, Convertible	Cabriolet, Convertible	Cabriolet	Descapotable	Descapotável	Cabriolet	Cabriolet	Кабриолет / Спайдер
	Fuoristrada	Off road	Tout terrain	Geländewagen	Todo terreno	Todo-o-Terreno	Terreinwagen	Offroad 4x4	Джип
	Van - Furgoncino	Van - Commercial	Utilitaire - Fourgonette	Kastenwagen	Furgoneta - Comercial	Veículo Comercial - Furgão	Bedrijfsvoertuig	Van	Фургон - Грузовик
	Pick-Up	Pick-Up	Pick-Up	Pick-Up	Pick-Up	Pick-Up	Pick-Up	Pickup	Комби
	Autobus - Minibus - Monovolume	Bus - Minibus - Multi purpose vehicle	Bus - Minibus - Monospace	Bus - Kleinbus - Multipurpose vehicle	Autobús - Minibús - Monovolumen	Autocarro - Furgoneta	Bus - Minibus - Monospace	Bus - Minibus	Автобус - Минибус - Многоцелевое транспортное средство
	Ambulanza	Ambulance	Ambulance	Krankenwagen	Ambulancia	Ambulância	Ziekenwagen	Ambulance	Скорая помощь
	Furgone - Camioncino	Van - Truck	Camion - Camionette	LKV - Kleinlaster	Camión ligero - Camioneta	Camião - Camioneta	Vrachtwagen - Bestelwagen	Varevogn	Фургон - Грузовик
	Autofelcio cabinato	Châssis cabine	Chassis Cab	Chassis Kabine	Chasis con cabina	Chassis de cabina	Chassis met cabine	Cab chassis/ Førerkabine	Грузопассажирский автомобиль
	Sinistra	Left hand	Gauche	Links	Izquierda	Lado esquerdo	Links	Venstre side	Правый
	Destra	Right hand	Droite	Rechts	Derecha	Lado direito	Rechts	Højre side	Левый
	Kit di protezione	Protection Kit	Kit de protection	Protection kit	Kit de protección	Jogo de Protecção	Beschermings-kit	Monterings kit	Защитный комплект
	Porte	Doors	Portes	Türen	Puertas	Portas	Deuren	Døre	Двери
	Ammortizzatore sterzo	Steering damper	Amortisseur de direction	Lenkungsdämpfer	Amortiguador de dirección	Amortecedor de Direcção	Stuurdemper	Styrdæmper	Амортизатор рулевой рейки
	Sterzo manuale	Without Power Steering	Sans direction assistée	Ohne Servolenkung	Sin dirección asistida	Sem Direcção Assistida	Met Stuurbekrachting	Ingen servostyring	Механическая рулевая рейка
	Servosterzo	Power Steering	Direction assistée	Mit Servolenkung	Dirección asistida	Direcção Assistida	Zonder stuurbekrachting	Servostyring	Рулевая рейка с гидроусилителем

									
	Cambio manuale	Manual transmission	Boîte manuelle	Schaltgetriebe	Transmisión manual	Transmissão manual	Manuele versnellingsbak	Manuel gearkasse	Механическая коробка передач
	Cambio Automatico	Automatic transmission	Boîte automatique	Automatikgetriebe	Transmisión automática	Transmissão automática	Automatische versnellingsbak	Automat gearkasse	Автоматическая коробка передач
N.D.	Standard	Normal duty	Standard	Standard Ausführung	Normal	Normal	Standaard	Normal	Стандарт
H.D.	Rinforzato	Heavy duty	Renforcé	Verstärkte Ausführung	Reforzado	Reforçado	Versterkt	Forstærket	Усиленный
	Ruota	Wheel	Roue	Rad	Rueda	Roda	Wiel	Hjul	Колесо
Susp.	Sospensione	Suspension	Suspension	Aufhängung	Suspensión	Suspensão	Ophanging	Ophæng/affjedring	Подвеска
	Sospensioni sportive	Sport suspension	Suspension sport	Sportfederung	Suspensión deportiva	Suspensão Desportiva	Sportvering	Sports-affjedring	Спортивная подвеска
	Sospensione per strade accidentate	For bad road suspension	Suspension pour routes dégradées	Federung für schlechte Straßen	Suspensión para carreteras en mal estado	Suspensão para maus pisos	Vering voor slecht wegdek	Affjedring til dårlig vej	Усиленная Подвеска
	Sospensione originale ribassata	Original lowered suspension	Suspension surbaissée	Tieferlegung	Suspensión rebajada original	Suspensão rebaixada	Verlaagde ophanging	Forsænket affjedring	Оригинальная спортивная подвеска
	Sospensione autolivellante	Self levelling suspension	Correcteur d'assiette	Niveau-Ausgleich-System	Suspensión autonivelante	Suspensão autonivelável	Ophanging met niveauregeling	Selvregulerende affjedring	Подвеска авторегулируемая
	Sospensione pneumatica	Air suspension	Suspension pneumatique	Lufffederung	Suspensión neumática	Suspensão pneumática	Pneumatische ophanging	Luftaffjedring	Пневматическая подвеска
	Sospensione idropneumatica	Hydropneumatic suspension	Suspension hydropneumatique	Hydropneumatische Aufhängung	Suspensión hidroneumática	Suspensão hidropneumática	Hydropneumatische ophanging	Hydraulisk affjedring	Гидропневматическая подвеска
	Sospensione regolabile elettronica	Electronically adjustable suspension	Suspension pilotée	Elektronisch einstellbare Federung	Suspensión ajustable electrónicamente	Suspensão regulável electronicamente	Elektronisch gestuurde ophanging	Elektronisk styret affjedring	Электронно-регулируемая подвеска
	Balestra	Leaf spring	Ressort à lames	Blattfeder	Muelle de láminas	Mola de lâminas	Bladveer	Bladfjeder	Рессора
	Molla elicoidale	Coil spring	Ressort hélicoïdale	Schraubenfeder	Muelle helicoidal	Mola helicoidal	Spiraalveer	Spiralfjeder	Спиральная пружина
	Ruote singole	Single wheel	Roues simples	Einzelbereifung	Ruedas simples	Rodas simples	Enkel wiel	Enkelthjul	Одиночные колеса
	Ruote gemelle	Twin wheels	Roues jumelées	Doppelbereifung	Ruedas dobles	Rodas duplas	Dubbele wielen	Tvillingehjul	Двойные колеса
	Asse rigido	Rigid axle	Essieu rigide	Feste Achse	Eje rígido	Eixo rígido	Vaste as	Stiv aksel	Жесткая ось
	Bracci indipendenti	Independant suspension	Suspensión indépendant	Unabhängige Aufhängung	Suspensión independiente	Suspensão independente	Onafhankelijke wielophanging	Uafhængig affjedring	Независимые рычаги
	Interasse	Wheel base distance	Empatement	Radstand	Distancia entre ejes	Distância entre eixos	Wielbasis-afstand	Hjulafstand	Межось

									
	Interasse corto	Short wheelbase	Empattement court	Kurzer Radstand	Distancia entre ejes corta	Dist. curta entre eixos	Korte wielbasis	Kort hjulafstand	Межось короткая
	Interasse medio	Medium wheelbase	Empattement moyen	Mittlerer Radstand	Distancia entre ejes media	Dist. média entre eixos	Middellange wielbasis	Medium hjulafstand	Межось средняя
	Interasse lungo	Long wheelbase	Empattement long	Langer Radstand	Distancia entre ejes larga	Dist. longa entre eixos	Lange wielbasis	Stor hjulafstand	Межось длинная
	Barra di torsione singola	2 torsion bars	Train à 2 barres de torsion	2 Torsionsstäbe	2 barras de torsión	2 barras estabilizadoras	2 torsiestangen	To torsiønstænger (snoede)	Двухторсионный стабилизатор
	Doppia barra di torsione	4 torsion bars	Train à 4 barres de torsion	4 Torsionsstäbe	4 barras de torsión	4 barras estabilizadoras	4 torsiestangen	Fire torsiønstænger (snoede)	Четырех торсионный стабилизатор
	Trazione	Front wheel drive	Traction	Vorderradantrieb	Tracción delantera	Tracção	Voorwielaanrijving	Forhjulstræk	Передний привод
	Propulsione	Rear wheel drive	Propulsion	Hinterradantrieb	Tracción trasera	Tracção traseira	Achterwielaanrijving	Baghjulstræk	Задний привод
	Asse anteriore	Front wheels	Roues Avant	Vorderachse	Tren Delantero	Dianteira	Voor	For aksel	Передняя ось
	Asse posteriore	Rear wheels	Roues Arrière	Hinterachse	Tren Trasero	Traseira	Achter	Bag aksel	Задняя ось
2WD - 4X2	2 ruote motrici	2 wheel drive	2 roues motrices	2 Radantrieb	2 ruedas motrices	Rodas Motrizes	2 aangedreven wielen	2 hjulstræk	2 ведущих колеса
4WD - 4X4	4 ruote motrici	4 wheel drive	4 roues motrices	4 Radantrieb	4 ruedas motrices	4 Rodas Motrizes	4 aangedreven wielen	4 hjulstræk	4 ведущих колеса
excl.	Escluso	Excluding	Exclus	Ausschließlich	Excluyendo	Excepto	Exclusief	Eksklusive	Исключено
incl.	Incluso	Including	Inclus	Einschließlich	Incluyendo	Inclusivé	Inclusief	Inklusive	Включено
→Ch. 000	Fino al numero di telaio	To chassis No.	Au chassis N°	Bis zur Fahrgestellnummer	Hasta el número de bastidor	Até ao Chassi N°	Tot chassisn°	Til stelnummer	До номера шасси
Ch. 000→	Dal numero di telaio	From chassis No.	Du chassis N°	Ab Fahrgestellnummer	Desde el número de bastidor	A Partir do Chassi N°	Vanaf chassisn°	Fra stelnummer	От номера шасси
O.E.	Riferimento originale	Original Part Number	Référence d'origine	Original Hinweis	Referencia original	Referência original	Origineel nummer	Originalt varenummer	Оригинальный код
ABS	Sistema antiblocco freni	Antilock Brakes System	Freins antiblocage	Antiblockier systeme	Frenos antibloqueo	ABS	Antiblokkeer remsysteem	Med ABS	Противоблокировочная система тормозов
675.021.0	Articolo nuovo immediatamente disponibile	New part number immediately available	Nouvelle référence immédiatement disponible	Neue Stossdämpfer sofort vorhanden	Nuevo número de pieza inmediatamente	disponibile Referência Nova Disponível	Nieuw nummer : direct leverbaar	Ny udviklede numre er klar til levering	Новый артикул, имеется в наличии
675.021.0	Articolo nuovo in fase di sviluppo	New part number in preparation	Nouvelle référence en préparation	Neue Hinweis in der Vorbereitung	Nuevo artículo en la preparación	Referência Nova em Desenvolvimento	Nieuw nummer in voorbereiding	Nyt varenummer under udvikling	Новый артикул в стадии разработки
<u>675.021.0</u>	Disponibile fino ad esaurimento scorte	Available until stock depleted	Disponible jusqu'à épuisement du stock	Solange Vorrat reicht	Disponibile hasta agotar existencias	Disponível até esgotar stock	Leverbaar zolang de voorraad strekt	Leveres så længe lager haves	В наличии до окончания стока



D.S.R.A.V. Alfeo Moret S.p.A. - Via dell'Industria 13, Zona Industriale
31029 Vittorio Veneto (TV) Italy - Tel. +39 0438 912090 r.a. Fax + 39 0438 501640
www.osrav.it webcatalog.osrav.it

TOP  **P** [®]
Line



17

CATALOGUE EDITION

**AMMORTIZZATORI / SHOCK ABSORBERS
AMORTISSEURS / STOSSDÄMPFER / AMORTIGUADORES**

OIL - GAS



- Sospensione MacPherson

- Complete MacPherson strut
- MacPherson komplettes Federbein
- Coluna de Suspensão MacPherson
- Komplet fjederben

- Jambe de force type MacPherson
- Columna de suspension
- Complete MacPherson veerpoet
- Подвеска Макферсона



- Ammortizzatore con piattello portamolla

- Shock absorber with spring seat
- Stossdämpfer mit Federsitzteller
- Amortecedor com Base para Mola
- Støddæmper med fjeder skål

- Amortisseur à siège de ressort
- Amortiguador con asiento para muelle
- Schokdemper met veerschotel
- Амортизатор с площадкой для установки пружины

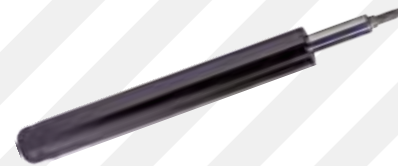

- Cartuccia di ricambio MacPherson

- MacPherson insert
- MacPherson Federbeinsatz
- Cartucho Substituição para Coluna Suspensão MacPherson
- Indsats

- Cartouche type Mac Pherson
- Cartucho accesorio para columna de suspensión
- MacPherson patroon
- Заменяемый вкладыш стойки Макферсона

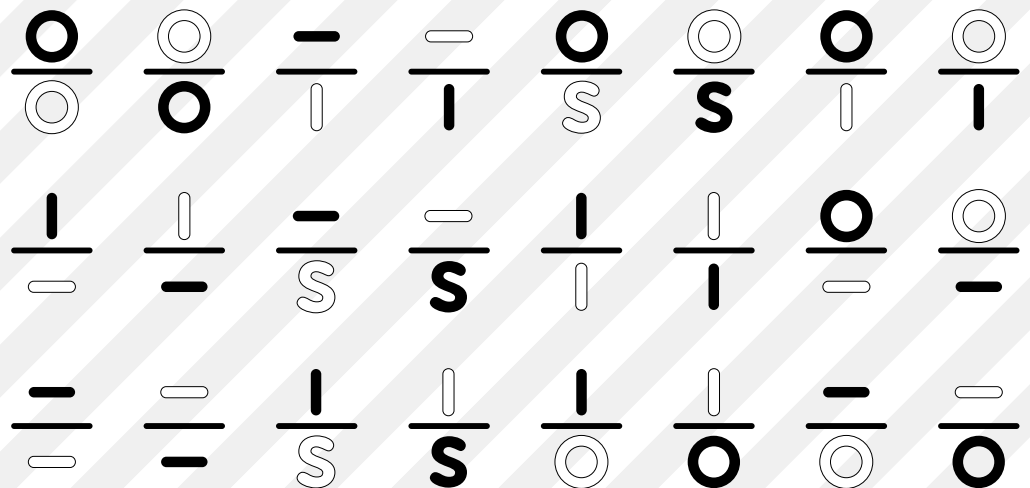

- Tipo di applicazione

- Application type
- Anwendung der Stossdämpfer
- Esquema de Montagem
- Anvendelse

- Type de application
- Esquema de anclajes
- Bevestiging van de schokdemper
- Вид применения



- Tempo di montaggio (min) per asse

- Assembly time (min.) for the axle
- Montagezeit (Min.) jeder Achse
- Tempo de Montagem (Min.) por Eixo
- Monterings tid (min) per aksel

- Temps de montage (min.) pour axe
- Tiempo de montaje (Min.) para eje
- Werktijd (Min.) per as
- Время монтажа (минут) на мост

SPECIALE NUOVO BRAND

L'AZIENDA OSRAV ADEGUA L'IMMAGINE A MISSION E PROGETTI. ECCO UN'INTERVISTA ESCLUSIVA. LE NOVITÀ DI OSRAV con interventi di Emilio e Guido Ardengo, *Sales e Marketing Manager* di Osrav Spa.

INNOVATIVE NEW BRAND - OSRAV ALIGNS IMAGE TO COMPANY VISION AND FUTURE PROSPECTS. HERE'S AN EXCLUSIVE INTERVIEW. OSRAV'S NEWS with the contribution of Emilio and Guido Ardengo, respectively Sales and Marketing Managers of Osrav Spa.



Perché oggi un nuovo nome?

Emilio Ardengo: "Nel vissuto del mondo dell' "automotive", Osrav interpreta da tempo e in modo attivo il mercato, proponendo soluzioni e prodotti con alta componente di servizio.

Nel corso degli anni abbiamo costruito un'immagine forte e stabile, caratterizzata da una grande attenzione alla qualità delle realizzazioni e da grande flessibilità nelle richieste con un sistema di approccio in grado di soddisfare puntualmente i clienti, sparsi in tutto il mondo.

La nostra gamma e l'esperienza ci consentono di essere sempre propositivi e di assicurare a ogni cliente il pacchetto di soluzioni su misura. Oggi con "**VITAL suspensions**" portiamo a coronamento tutto il lavoro, dotandoci di un brand evocativo e internazionale che bene si adatta a ciò che siamo e facciamo."

Why a new denomination?

Emilio Ardengo: "Osrav has always been an active part of the automotive market, offering solutions and realizing products with a high service component.

With time, Osrav has built a strong and solid image of high quality standards for its products and of informed flexibility and punctuality, effectively meeting the demands of its clients worldwide.

The extensive product range and the expertise allow for greater proactive capacity guaranteeing tailor-made packages for each client.

Today with "**VITAL suspensions**" we crown all the effort and perseverance with an evocative and international new brand which embodies the essence of who we are and what we do."

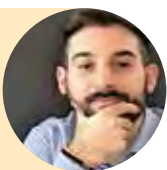

VITAL cosa significa?

Guido Ardengo: "**Cinque lettere che caratterizzano... una molteplicità di significati!** Innanzi tutto è una parola internazionale

le cucita a misura della nostra filosofia di lavoro, sempre dinamica e propositiva. Non solo, è anche la nostra missione: fare ammortizzatori che siano "Vital", mantengano la qualità vitale della loro funzione attiva e passiva per una guida, a sua volta: Vital!

Ma Vital contiene anche "ital" a suggellare la nostra sincera e fattiva italianità, contiene le iniziali di Vittorio Veneto la città veneta della nostra sede e contiene "Al", iniziale di Alfeo Moret, colui che ha voluto e creato questa azienda nel 1973, e che le ha dato quello spirito di intraprendenza che oggi è il nostro successo."

What does VITAL mean?

Guido Ardengo: "**A five-letter multiple meaning word!** First of all, it is an international word that perfectly matches our work philosophy always proactive and dynamic. It then represents our company's mission; to produce shock absorbers that are truly VITAL, able to maintain their high quality long lasting active and passive functioning guaranteeing in turn a VITAL driving experience. However, to consolidate the genuine Italian authenticity that we proudly incorporate, VITAL contains "ITAL", but also the initials of the Venetian city, Vittorio Veneto, where we are located.

Above all, VITAL, includes an essential component, "AL", initials for Alfeo Moret, the father founder of our company, who already in 1973 established this company

with a great entrepreneurial spirit and futurist vision which have laid the foundation of our current success."





FORTI DI NATURA!

BORN TO BE STRONG!

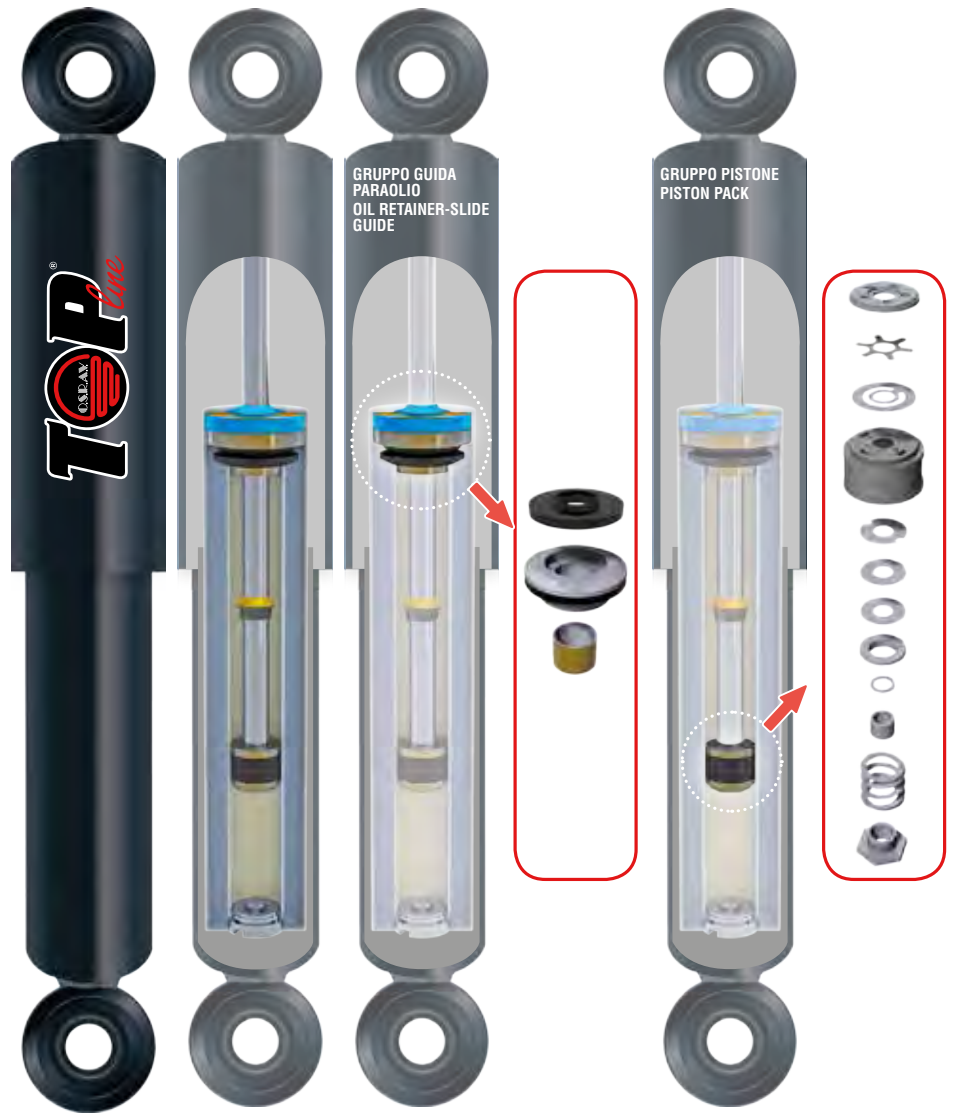

QUALITÀ, PREZZO E SERVIZIO!

Presente sul mercato da oltre 40 anni, Osrav produce sistemi di sospensione per autoveicoli secondo specifiche di qualità ormai consolidate ISO. Forte di questa continua esperienza e competenza, grazie al personale altamente qualificato e motivato, studia e sviluppa la linea di Ammortizzatori TOP LINE come soluzione ideale per ogni esigenza del mercato del ricambio.

L'utilizzo di specifiche attrezzature, la semplificazione dei processi produttivi e l'impiego di componenti ampiamente testati e sempre aggiornati nel disegno e nei materiali, ci consente di certificare una **garanzia di 2 anni sul prodotto**. Il servizio tecnico post-vendita per il cliente fidelizzato, che solo la nostra struttura è in grado di erogare, è un'ulteriore garanzia aggiuntiva. **TOP LINE: la migliore sintesi sul mercato per QUALITÀ/PREZZO e SERVIZIO.**

SAFETY, COMFORT AND QUALITY!

Present in the market for over 40 years, Osrav produces suspension systems for vehicles following ISO quality consolidated specifications. Strong of this experience and competency, thanks to the highly qualified and motivated staff, Osrav studies the TOP LINE Shock Absorbers line as ideal solution for every kind of aftermarket demand.

The use of specific equipment, the simplification of production processes and the commitment of components extensively tested and always been updated on drawing and material, allow us to certify a **guarantee of 2 years on the product**. Our technical post sales service, which only our Company is able to do (for the aim Top Line has), is an important further guarantee. **TOP LINE: our best synthesis on the market for QUALITY/PRICE and SERVICE.**

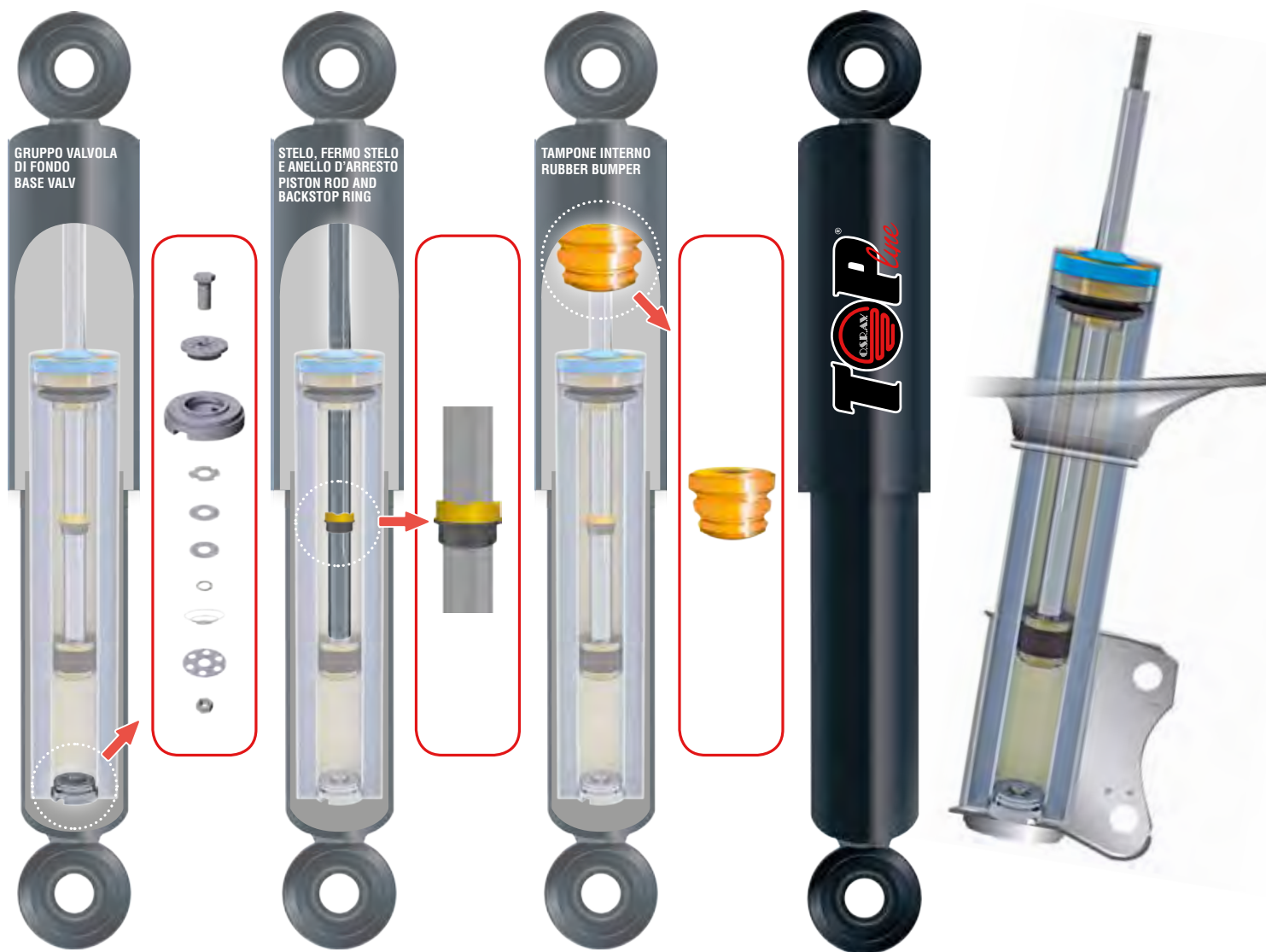

CONSULTAZIONE CATALOGO

pag. 1

How to look up in the catalogue - Consultation du catalogue - Nachschlage des Katalog - Consulta de catálogo - Consulta de Catálogo

Consultatie van de catalogus - Sådan slår du op i kataloget - Руководство пользователя

ALFA ROMEO	pag. 2	HONDA	pag. 6	PEUGEOT	pag. 11
AUDI	pag. 2	HYUNDAI	pag. 6	PIAGGIO	pag. 11
BMW	pag. 2	JEEP	pag. 7	RENAULT	pag. 12
CHEVROLET	pag. 3	KIA	pag. 7	SEAT	pag. 13
CHRYSLER	pag. 3	LAND ROVER	pag. 8	SKODA	pag. 13
CITROËN	pag. 3	MAZDA	pag. 8	SUZUKI	pag. 13
DACIA	pag. 4	MERCEDES	pag. 8	TOYOTA	pag. 14
DAIHATSU	pag. 4	MINI	pag. 9	VOLKSWAGEN	pag. 14
DR	pag. 4	MITSUBISHI	pag. 9	VOLVO	pag. 15
FIAT	pag. 5	NISSAN	pag. 9		
FORD	pag. 6	OPEL	pag. 10		

CONDIZIONI GENERALI DI VENDITA

pag. 22

General sales term and conditions - Conditions générales de ventes - Allgemeine Verkaufsbedingungen - Condiciones generales de las ventas

Condições Gerais de Venda - Algemene verkoopcondities - Generale salgs konditioner - Основные условия продажи

PRINCIPALI CAUSE DI DANNEGGIAMENTO NON IMPUTABILI A DIFETTOSITÀ DEL PRODOTTO

pag. 24

Principle defects due to improper handling of product

ATTACCHI AMMORTIZZATORI

pag. 26

Shock absorbers end fitting - Type des fixations des amortisseurs - Befestigung der Stossdämpfer - Esquema de anclajes

Diagrama de Montagem de Amortecedores - Bevestigingstype van de schokdemper - Monterings vejledning - Крепления амортизаторов

LEGENDA

pag. 27

Legend - Legende - Bemerkung - Leyenda - Legenda - Legende - Bemærkning - Легенда

CONSULTAZIONE CATALOGO

How to look up in the catalogue - Consultation du catalogue - Nachschlage des Katalog - Consulta de catálogo
 Consulta de Catálogo - Consultatie van de catalogus - Sădan slår du op i kataloget. - Руководство пользователя



**ANTERIORE
FRONT**









**POSTERIORE
REAR**



		OIL	GAS				OIL	GAS		
---	---	------------	------------	---	---	---	------------	------------	---	---

BMW (D)

3 SERIES (E36) EXCL. M-TECHNIK

 316i	06.92 - 02.98		<i>BW036AS</i>	BW036AS/GL		160		<i>BW034P</i>	BW034P/GL		60
 318is	06.92 - 02.98		<i>BW036AD</i>	BW036AD/GL		160					
			 ACC57								

Data

Date - Date
 Baujahr - Fecha
 Data - Bouwjaar
 Productions år - Дата

Marca/Costruttore

Manufacturer - Fabricant
 Hersteller - Marca/Constructor
 Fabricante - Merk
 Fabrikant - Производитель

Specifica Modello

Model specifications - Caractéristiques modèles
 Besonderheit - Especificación modelo
 Especificação modelo - Model-Specificaties
 Model Betegnelse - Объем двигателя

Modello Veicolo

Model - Modèle
 Modell - Modelo
 Modelo - Model
 Model - Модель

Note

Note - Notes
 Anmerkungen - Anotación
 Nota - Opmerkingen
 Bemærkning - примечания

Ammortizzatori idraulici

Hydraulic shock absorbers - Amortisseurs hydrauliques
 Hydraulische Stossdämpfer - Amortiguadores hidráulicos
 Amortecedores Hidráulicos - Hydraulische schokdempers
 Olie støddæmper - Гидравлические амортизаторы

Ammortizzatori a gas

Gas charged shock absorbers - Amortisseurs à Gaz
 Gasdruck Stossdämpfer - Amortiguadores de Gas
 Amortecedores a Gás - Gas-Schokdempers
 Gas støddæmper - Газовые амортизаторы

Tipo di applicazione

Application type - Type de application
 Anwendung der Stossdämpfer - Esquema de anclajes
 Esquema de Montagem - Bevestiging van de schokdemper
 Anvendelse - Вид применения

Tempo di montaggio (min) per asse

Assembly time (Min.) for the axle - Temps de montage (min.) pour axe
 Montagezeit (Min.) jeder Achse - Tiempo de montaje (Min.) para eje
 Tempo de Montagem (Min.) por Eixo - Werktijd (min) per as
 Monterings tid (min) per aksel - Время установки

LEGENDA CODICI - CODES





MR111P **Italico**

Codice ad esaurimento - Code available until stock depleted
 Référence disponible jus'q'à epuissement du stock - Solange Vorrat reicht
 Codigo disponible hasta agotar existencias - Artigo disponível até esgotar stock
 Leverbaar zolang de voorraad strekt - Leveres så længe lager haves - Код В ликвидации

MR111P/GL **Italico sottolineato**

Codice Esaurito - Code sold out
 Référence épuisée - Artikel verbruucht
 Artículo Exhausto - Referencia terminado
 Code uf - Code ud - Код закончена

VITO I

 ,  excl.  , 	(638)	02.96 - 10.03		MR111A	MR111A/GL			N.D.	<i>MR111P</i>	<i>MR111P/GL</i>		
								H.D.	MR112P	MR112P/GL		

MR111A Grassetto

Codice nuovo disponibile - New code available
 Nouvelle référence disponible - Neue Stossdämpfer vorhanden
 Nuevo código disponible - Nova Referência disponível
 Nieuw nummer leverbaar - Ny udviklede numre levering
 Новый код доступны

MR111A/GL Grassetto sottolineato

Codice nuovo non disponibile - New code not available
 Nouvelle référence pas disponible - Neue Stossdämpfer nicht vorhanden
 Nuevo código no disponible - Nova Referência no disponível
 Nieuw nummer niet leverbaar - Ny udviklede numre ikke levering
 Новый код не доступен

MR112P Normale

Codice Corrente - Current code
 Référence courante - Gebrauchsartikel
 Artículo corriente - Artigo atual huidige artikel
 artikel - Nuværende artikel
 активный код

MR112P/GL Normale sottolineato

Codice Corrente non disponibile
 Current code not available - Référence courante pas disponible
 Gebrauchsartikel nicht vorhanden - Artículo corriente no disponible
 Artigo atual no disponível - huidige artikel niet leverbaar
 Nuværende artikel ikke levering - активный код не доступен

OIL
GAS

OIL
GAS

ALFA ROMEO (I)

GIULIA

RWD excl. , 4WD	03.16 -			<u>AR054AS/GL</u>				<u>AR054P/GL</u>	$\frac{1}{0}$	
				<u>AR054AD/GL</u>						
4WD excl.	03.16 -			<u>AR055AS/GL</u>				<u>AR055P/GL</u>	$\frac{1}{0}$	
				<u>AR055AD/GL</u>						

AUDI (D)

A6 IV (4G) EXCL. ALLROAD

excl. (4G2, C7, 4GC)	03.11 -							<u>AU052P/GL</u>	$\frac{1}{0}$	80
excl. (4G5, C7, 4GC)	05.11 -									
(4G2, C7, 4GC)	03.11 -								$\frac{1}{0}$	
(4G5, C7, 4GC)	05.11 -									

TT

excl. (FV3)	07.14 -			<u>VW046A/GL</u>	140			<u>VW046P/GL</u>	$\frac{1}{0}$	80
excl. (FV3)	07.14 -			<u>VW046A/GL</u>	140			<u>VW046P/GL</u>	$\frac{1}{0}$	80

BMW (D)

5 SERIES TOURING (F11)

excl. (F11)	04.10 -			<u>BW069AS/GL</u>	120			<u>BW077P/GL</u>	$\frac{1}{0}$	100
				<u>BW069AD/GL</u>						

6 SERIES TOURING (F12, F13)

640i, 650i, 640d, excl. (F12)	03.11 -							<u>BW078P/GL</u>		120
640i, 650i, 640d, excl. (F12)	10.11 -							<u>BW078P/GL</u>		120

X1 (F48)

excl. X-Drive, (F48)	09.15 -			<u>BW082AS/GL</u>				<u>BW082P/GL</u>	$\frac{1}{0}$	80
				<u>BW082AD/GL</u>						

X3 (F25)

excl. X-Drive, (F25)	09.10 -			<u>BW079AS/GL</u>	190			<u>BW079P/GL</u>		100
				<u>BW079AD/GL</u>						

X4 (F26)

excl. X-Drive, (F26)	04.14 -			<u>BW079AS/GL</u>	190			<u>BW079P/GL</u>		100
				<u>BW079AD/GL</u>						



ANTERIORE
FRONT

POSTERIORE
REAR



OIL

GAS



OIL

GAS



CHEVROLET (EU)

AVEO

	(T300)	03.11								OG057P/GL	$\frac{1}{0}$	50
--	--------	-------	--	--	--	--	--	--	--	-----------	---------------	----

ORLANDO

16, 17 e 18 inch	(J309)	02.11			OG063AS/GL		80			DW012P/GL	$\frac{1}{0}$	50
					OG063AD/GL							

SPARK

	(M300)	03.10								DW013P/GL	$\frac{1}{0}$	45

CHRYSLER (USA)

GRAND VOYAGER

excl.	(RT)	10.07 -			LN051A/GL		180			LN051P/GL	$\frac{0}{0}$	80
-------	------	---------	--	--	-----------	--	-----	--	--	-----------	---------------	----

CITROËN (F)

C4 AIRCROSS

		04.12 -			MT040AS/GL		200			MT040P/GL		120
					MT040AD/GL							

C4 CACTUS

		09.14 -								CI035P/GL	$\frac{0}{0}$	110
--	--	---------	--	--	--	--	--	--	--	-----------	---------------	-----

C4 PICASSO II/GRAN PICASSO II

Picasso		02.13 -			PG059A/GL		180			PG059P/GL	$\frac{1}{0}$	60
Gran Picasso												

C-ELYSEE

		11.12 -			CI036AS/GL					CI036P/GL	$\frac{0}{0}$	
					CI036AD/GL							

DS3

		01.13 -			CI032AS/GL		180			CI032P/GL	$\frac{0}{0}$	90
Diametro mozzo ammortizzatore Ø 51 mm					CI032AD/GL							
		01.13 -			CI033AS/GL		180			CI032P/GL	$\frac{0}{0}$	90
Diametro mozzo ammortizzatore Ø 47 mm					CI033AD/GL							

DS5

		11.11 -			CI037AS/GL		130			CI030P/GL	$\frac{0}{0}$	100
					CI037AD/GL							

OIL
GAS

OIL
GAS

DACIA (R)

DOKKER

	11.12 -			DC010A/GL		100			DC010P/GL	$\frac{1}{0}$	45
--	---------	--	--	-----------	--	-----	--	--	-----------	---------------	----

LODGY

	03.12 -			DC011A/GL		100			DC011P/GL	$\frac{1}{0}$	45
--	---------	--	--	-----------	--	-----	--	--	-----------	---------------	----

LOGAN II

	10.12 -			DC008A/GL		90			DC008P/GL	$\frac{1}{0}$	70
MCV	02.13 -			DC008A/GL		90					

SANDERO II

	10.12 -			DC009A/GL		140			DC008P/GL	$\frac{1}{0}$	70
--	---------	--	--	-----------	--	-----	--	--	-----------	---------------	----

DAIHATSU (J)

TERIOS II

excl. 1.5 WT-i RWD	(J2) 05.06 - 10.08			DA006A/GL		160			DA006P/GL	$\frac{1}{0}$	100
--------------------	--------------------	--	--	-----------	--	-----	--	--	-----------	---------------	-----

DR (I)

CITYCROSS

1.3, 1.3 GPL, 1.3 METANO	01.14 -			DR001A/GL		90			DR003P/GL	$\frac{1}{0}$	55
--------------------------	---------	--	--	-----------	--	----	--	--	-----------	---------------	----

DR 0

1.0	01.15 -			DR001A/GL		90			DR001P/GL	$\frac{1}{0}$	45
-----	---------	--	--	-----------	--	----	--	--	-----------	---------------	----

DR 1

1.1, 1.3	03.10 -			DR001A/GL		90			DR001P/GL	$\frac{1}{0}$	45
----------	---------	--	--	-----------	--	----	--	--	-----------	---------------	----

DR 2

1.3	09.10 -			DR001A/GL		90			DR001P/GL	$\frac{1}{0}$	45
-----	---------	--	--	-----------	--	----	--	--	-----------	---------------	----

DR 5

1.6, 1.8, 2.0, 1.9D	01.11 -			DR002AS/GL DR002AD/GL		110			DR002P/GL	$\frac{1}{0}$	55
---------------------	---------	--	--	--------------------------	--	-----	--	--	-----------	---------------	----



ANTERIORE
FRONT

POSTERIORE
REAR



		OIL	GAS				OIL	GAS		
--	--	------------	------------	--	--	--	------------	------------	--	--

FIAT (I)

124 SPIDER

excl.	(348)	03.16 -			FI376A/GL				FI376P/GL		
	(348)	03.16 -									

500 L

Living	(199_)	09.12 -			FI366AS/GL FI366AD/GL		90		FI375P/GL		50
--------	--------	---------	--	--	--------------------------	--	----	--	------------------	--	----

500 X

excl. 4WD	(334)	09.14 -			FI373AS/GL FI373AD/GL		110			FI373PS/GL FI373PD/GL		100
4WD	(334)	09.14 -			FI374AS/GL FI374AD/GL		110			FI374PS/GL FI374PD/GL		100

1

FI373AD/GL
FI373AS/GL
FI373PD/GL
FI373PS/GL
A = 58 mm
B = 25 mm

2

FI374AD/GL
FI374AS/GL
FI374PD/GL
FI374PS/GL
A = 72 mm
B = 35 mm

TIPO

4 porte	(356)	10.15 -			FI377AS/GL FI377AD/GL				FI377P/GL		
5 porte	(356)	05.16 -									
	(356)	09.16 -									

OIL
GAS

OIL
GAS

FORD (EUR)

B-MAX

	(JK)	10.12 -	 		<u>FR089AS/GL</u> <u>FR089AD/GL</u>	 	150			<u>FR089P/GL</u>		
--	------	---------	------	--	--	------	-----	--	--	------------------	--	--

FIESTA VI

		09.12 -	 		<u>FR091AS/GL</u> <u>FR091AD/GL</u>	 	110			<u>FR090P/GL</u>		45
--	--	---------	------	--	--	------	-----	--	--	------------------	--	----

TOURNEO

Courier Kombi excl. Connect, Grand Connect Kombi, Custom autobus		01.14 -	 		<u>FR089AS/GL</u> <u>FR089AD/GL</u>	 	130			<u>FR090P/GL</u>		50
---	--	---------	------	--	--	------	-----	--	--	------------------	--	----

TRANSIT

Courier Kombi excl. Connect, Furgonato, Custom, Pianale		01.14 -	 		<u>FR089AS/GL</u> <u>FR089AD/GL</u>	 	130			<u>FR090P/GL</u>		50
--	--	---------	------	--	--	------	-----	--	--	------------------	--	----

HONDA (J)

CR-V III

	(RE)	01.07 - 12.11	 		<u>HD048AS/GL</u> <u>HD048AD/GL</u>	 	140			<u>HD048P/GL</u>		140
--	------	---------------	------	--	--	------	-----	--	--	------------------	--	-----

CR-V IV

excl. 4WD	(RE)	10.12 -	 		<u>HD048AS/GL</u> <u>HD048AD/GL</u>	 	140			<u>HD049P/GL</u>		140
-----------	------	---------	------	--	--	------	-----	--	--	------------------	--	-----

HYUNDAI (KO)

ACCENT IV

	(RB)	11.10 -	 			 				<u>HY035P/GL</u>		45
--	------	---------	------	--	--	------	--	--	--	------------------	--	----

i30 I

CW	(FD)	10.07 - 06.12	 		<u>HY036AS/GL</u> <u>HY036AD/GL</u>	 	70			<u>HY032P/GL</u>		55
----	------	---------------	------	--	--	------	----	--	--	------------------	--	----

i30 II

excl. CW	(GD)	11.11 -	 			 				<u>HY032P/GL</u>		55
----------	------	---------	------	--	--	------	--	--	--	------------------	--	----

i40

excl. CW	(VF)	03.12 -	 		<u>HY038AS/GL</u> <u>HY038AD/GL</u>	 	90			<u>HY038P/GL</u>		55
CW	(VF)	07.11 -	 		<u>HY038AS/GL</u> <u>HY038AD/GL</u>	 	90			<u>HY038P/GL</u>		55

OIL
GAS

OIL
GAS

HYUNDAI (KO)

ix35

excl. 4WD	(LM, EL, ELH)	01.10 -			<u>KI024AS/GL</u>		90			KI024P/GL	$\frac{1}{1}$	40
					<u>KI024AD/GL</u>							
4WD	(LM, EL, ELH)	01.10 -			<u>KI024AS/GL</u>		90			KI025P/GL	$\frac{1}{0}$	40
					<u>KI024AD/GL</u>							

JEEP (USA)

RENEGADE

excl. 4WD	(BU)	07.14 -			F373AS/GL		110			F373PS/GL		100
					F373AD/GL					F373PD/GL		
4WD	(BU)	07.14 -		1	F374AS/GL		110			F374PS/GL		100
				2	F374AD/GL					F374PD/GL		

1 2

- 1** Vedi disegno/nota Fiat 500X a pagina 5
- 2** See drawing/note Fiat 500X on page 5
- F** Voir plan/note Fiat 500X à la page 5
- D** Siehe Fiat 500X Zeichnung/Anmerkung auf Seite 5
- E** Ver dibujo/anotación Fiat 500X a la página 5
- P** Ver figura/nota Fiat 500X na página 5

KIA (KO)

CEE'D

excl. Sportwagon	(JD)	05.12 -								HY032P/GL	$\frac{1}{1}$	55
Sportwagon	(JD)	09.12								HY032P/GL	$\frac{1}{1}$	55

PICANTO II

	(TA)	05.11 -			<u>KI023AS/GL</u>		70			KI023P/GL	$\frac{1}{0}$	40
					<u>KI023AD/GL</u>							

RIO III

	(UB)	09.11 -			<u>KI026AS/GL</u>		80			HY035P/GL	$\frac{0}{0}$	45
					<u>KI026AD/GL</u>							

SORENTO II

	(XM)	11.09-09.12			<u>HY029AS/GL</u>		90			HY029P/GL	$\frac{0}{0}$	45
					<u>HY029AD/GL</u>							

OIL
GAS

OIL
GAS

KIA (KO)

SPORTAGE

excl. AWD	(SL)	07.10 - 12.15			<u>KI024AS/GL</u>	90			<u>KI024P/GL</u>	$\frac{1}{2}$	40
AWD	(SL)	07.10 - 12.15			<u>KI024AS/GL</u> <u>KI024AD/GL</u>	90			<u>KI025P/GL</u>	$\frac{1}{2}$	40

LAND ROVER (GB)

FREELANDER II

excl.	(LF_, FA_)	10.06 - 10.14			<u>LR012AS/GL</u> <u>LR012AD/GL</u>	110			<u>LR012PS/GL</u> <u>LR012PD/GL</u>	$\frac{1}{2}$	160
-------	------------	---------------	--	--	--	-----	--	--	--	---------------	-----

MAZDA (J)

CX-5

excl. ALKS01	(KE, GH)	11.11 -			<u>MZ030AS/GL</u> <u>MZ030AD/GL</u>	70			<u>MZ030P/GL</u>	$\frac{1}{2}$	40
--------------	----------	---------	--	--	--	----	--	--	------------------	---------------	----

MERCEDES (D)

A CLASS

	(W168)	07.97 - 08.04			<u>MR011A/GL</u>	100			<u>MR011P/GL</u>	$\frac{1}{2}$	80
Alternativa con piattello in alluminio	(W168)	07.97 - 08.04			<u>MR036A/GL</u>	100			<u>MR011P/GL</u>	$\frac{1}{2}$	80
	(W169)	09.04 - 06.12			<u>MR024A/GL</u>	140			<u>MR024P/GL</u>	$\frac{1}{2}$	70
Alternativa monotubo al posteriore	(W169)	09.04 - 06.12			<u>MR024A/GL</u>	140			<u>MR037P/GL</u>	$\frac{1}{2}$	70

B CLASS

	(W245)	03.05 - 11.11			<u>MR024A/GL</u>	140			<u>MR024P/GL</u>	$\frac{1}{2}$	70
Alternativa monotubo al posteriore	(W245)	03.05 - 11.11			<u>MR024A/GL</u>	140			<u>MR037P/GL</u>	$\frac{1}{2}$	70

CLA

excl. 4-matic, AMG	(C117)	01.13 -			<u>MR033AS/GL</u> <u>MR033AD/GL</u>	160			<u>MR033P/GL</u>	$\frac{1}{2}$	100
Shooting Brake excl. 4-matic, AMG	(X117)	01.15 -			<u>MR033AS/GL</u> <u>MR033AD/GL</u>	160			<u>MR033P/GL</u>	$\frac{1}{2}$	100

CITAN

	(415)	11.12 -			<u>RN099A/GL</u>				<u>RN096P/GL</u>	$\frac{1}{2}$	
--	-------	---------	--	--	------------------	--	--	--	------------------	---------------	--

E CLASS

	(A207)	01.10 -			<u>MR038A/GL</u>	130			<u>MR038P/GL</u>	$\frac{1}{2}$	90
	(C207)	01.09 -			<u>MR038A/GL</u>	130			<u>MR038P/GL</u>	$\frac{1}{2}$	90



		OIL	GAS				OIL	GAS		
--	--	------------	------------	--	--	--	------------	------------	--	--

MERCEDES (D)

GLA

excl. 4-matic, AMG	(X156)	12.13 -			<u>MR039AS/GL</u>		160			<u>MR039P/GL</u>		100
					<u>MR039AD/GL</u>							

MINI (GB)

CABRIOLET

excl. ,	(F57)	11.15 -			<u>BW083AS/GL</u>					<u>BW080P/GL</u>		
					<u>BW083AD/GL</u>							

COUNTRYMAN

excl. ,	(R60)	06.10			<u>BW081AS/GL</u>		100			<u>BW081PS/GL</u>		60
					<u>BW081AD/GL</u>					<u>BW081PD/GL</u>		

MINI

excl. ,	(F56)	12.13 -			<u>BW083AS/GL</u>					<u>BW080P/GL</u>		
					<u>BW083AD/GL</u>							
excl. ,	(F55)	07.14 -			<u>BW083AS/GL</u>					<u>BW080P/GL</u>		
					<u>BW083AD/GL</u>							

PACEMAN

excl. ,	(R61)	04.12 -			<u>BW081AS/GL</u>		100			<u>BW081PS/GL</u>		60
					<u>BW081AD/GL</u>					<u>BW081PD/GL</u>		

ROADSTER

excl.	(R59)	02.12 -			<u>BW068AS/GL</u>		100			<u>BW068PS/GL</u>		60
					<u>BW068AD/GL</u>					<u>BW068PD/GL</u>		

MITSUBISHI (J)

ASX

	(GA_W_)	02.10 -			<u>MT040AS/GL</u>		150			<u>MT040P/GL</u>		80
					<u>MT040AD/GL</u>							

NISSAN (J)

NOTE

	(E12)	06.13 -			<u>NI072AS/GL</u>		160			<u>NI072P/GL</u>		50
					<u>NI072AD/GL</u>							

OIL
GAS

OIL
GAS

NISSAN (J)

NV400

				excl. ruote gemelle	11.11 -				OG068A/GL		100			OG068P/GL		40
				excl. ruote gemelle	11.11 -				OG068A/GL		100			OG069P/GL		40
				incl. ruote gemelle	11.11 -									OG070P/GL		40

PIXO

		(UA0)	06.09 -											NI075P/GL		50
--	--	-------	---------	--	--	--	--	--	--	--	--	--	--	-----------	--	----

PULSAR

		(C13)	10.14 -											NI078P/GL		50
--	--	-------	---------	--	--	--	--	--	--	--	--	--	--	-----------	--	----

QASHQAI II

	excl. 4WD	(J11, J11_)	11.13 -						NI076AS/GL		140			NI076P/GL		40
									NI076AD/GL							
	4WD	(J11, J11_)	11.13 -						NI076AS/GL		140			NI077P/GL		40
									NI076AD/GL							

X-TRAIL

	incl. 4WD	(T32)	12.13 -											NI077P/GL		40
--	-----------	-------	---------	--	--	--	--	--	--	--	--	--	--	-----------	--	----

OPEL (D)

AGILA

	1.3 CDTi	(H00)	08.03 - 12.07						OG067AS/GL		90			OG052P/GL		45
									OG067AD/GL							

COMBO

		Furgonato, Tour excl. trasporto persone (X12)	02.12 -						F352AS/GL		110			F352P/GL		40
									F352AD/GL							
	Promiscuo (trasporto persone)	(X12)	02.12 -						F352AS/GL		110			F367P/GL		40
									F352AD/GL							

CORSA

	excl. 1.6 turbo,	(E)	09.14 -						OG072AS/GL		70			OG072P/GL		50
									OG072AD/GL							
	Van	(E)	09.14 -						OG072AS/GL		70			OG072P/GL		50
									OG072AD/GL							

MOKKA

	excl. 4x4,		06.12 -						OG071AS/GL		80			OG071P/GL		50
									OG071AD/GL							

MOVANO B

				excl. ruote gemelle	(B)	05.10 -			OG068A/GL		100			OG068P/GL		40
				excl. ruote gemelle	(B)	05.10 -			OG068A/GL		100			OG069P/GL		40
				incl. ruote gemelle	(B)	05.10 -								OG070P/GL		40



		OIL	GAS				OIL	GAS		
--	--	------------	------------	--	--	--	------------	------------	--	--

PEUGEOT (F)

301

	04.14 -	 		PG060AS/GL PG060AD/GL					PG060P/GL		
--	---------	------	--	--------------------------	--	--	--	--	-----------	--	--

308 II

 excl. 1.6 THP, 1.6 GT 205, 1.6 Gti, 2.0 GT HdI,	09.13 -			PG059A/GL		180			PG059P/GL		60
---	---------	--	--	-----------	--	-----	--	--	-----------	--	----

2008

	03.13 -	 		PG057AS/GL PG057AD/GL		180			PG057P/GL		90
	03.13 -	 		PG058AS/GL PG058AD/GL		180			PG057P/GL		90

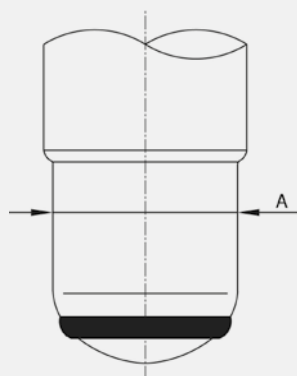
1
PG057AS/GL
PG057AD/GL

A= Ø 47 mm

2
PG058AD/GL
PG058AS/GL

A= Ø 51 mm

VERIFICARE DIAMETRO MOZZO ORIGINALE
CHECK THE ORIGINAL HUB DIAMETER

4008

	05.12 - 08.13	 		MT040AS/GL MT040AD/GL					MT040P/GL		
--	---------------	------	--	--------------------------	--	--	--	--	-----------	--	--

PIAGGIO (I)

PORTER

maxxi, 4WD, 1100 kg, ribaltabile	2002 -	 		PI004AS/GL PI004AD/GL					PI001P		
euro 5 (D120)	2011 -	 		PI003AS/GL PI003AD/GL					PI003P		

OIL
GAS

OIL
GAS

RENAULT (F)

CAPTURE

		06.13 -			<u>RN202A/GL</u>		120			<u>RN202P/GL</u>	$\frac{1}{0}$	45
--	--	---------	--	--	------------------	--	-----	--	--	------------------	---------------	----

CLIO III

	Grantour excl.	(KR0/1) 02.08 -			<u>RN081A/GL</u>		130			<u>RN081P/GL</u>	$\frac{1}{0}$	45
--	----------------	-----------------	--	--	------------------	--	-----	--	--	------------------	---------------	----

CLIO IV

	Grantour	01.13 -			<u>RN200A/GL</u>		130			<u>RN200P/GL</u>	$\frac{1}{0}$	45
--	----------	---------	--	--	------------------	--	-----	--	--	------------------	---------------	----

KADJAR

	excl. 4WD	06.15 -			<u>NI076AS/GL</u>		140			<u>NI076P/GL</u>	$\frac{0}{0}$	40
					<u>NI076AD/GL</u>							
	4WD	06.15 -			<u>NI076AS/GL</u>		140			<u>NI077P/GL</u>	$\frac{0}{0}$	40
					<u>NI076AD/GL</u>							

LATITUDE

		(L70) 07.10 -			<u>RN203AS/GL</u>					<u>RN203P/GL</u>	$\frac{1}{0}$	
					<u>RN203AD/GL</u>							

MASTER

				excl. ruote gemelle	(B)	05.10 -			<u>OG068A/GL</u>		100			<u>OG068P/GL</u>	$\frac{0}{0}$	40
				excl. ruote gemelle	(B)	05.10 -			<u>OG068A/GL</u>		100			<u>OG069P/GL</u>	$\frac{0}{0}$	40
				incl. ruote gemelle	(B)	05.10 -								<u>OG070P/GL</u>	$\frac{0}{0}$	40

SANDERO/STEPWAY I

		11.07 -			<u>DC005A/GL</u>		70			<u>DC005P/GL</u>	$\frac{1}{0}$	40
--	--	---------	--	--	------------------	--	----	--	--	------------------	---------------	----

TWINGO III

		09.14 -			<u>RN201A/GL</u>					<u>RN091P/GL</u>	$\frac{1}{0}$	
--	--	---------	--	--	------------------	--	--	--	--	------------------	---------------	--

WIND

		(E4M_) 07.10 -			<u>RN204A/GL</u>					<u>RN204P/GL</u>	$\frac{1}{0}$	
--	--	----------------	--	--	------------------	--	--	--	--	------------------	---------------	--

ZOE

		06.12 -			<u>RN205A/GL</u>					<u>RN205P/GL</u>	$\frac{1}{0}$	
--	--	---------	--	--	------------------	--	--	--	--	------------------	---------------	--



OIL
GAS

OIL
GAS

SEAT (E)

LEON

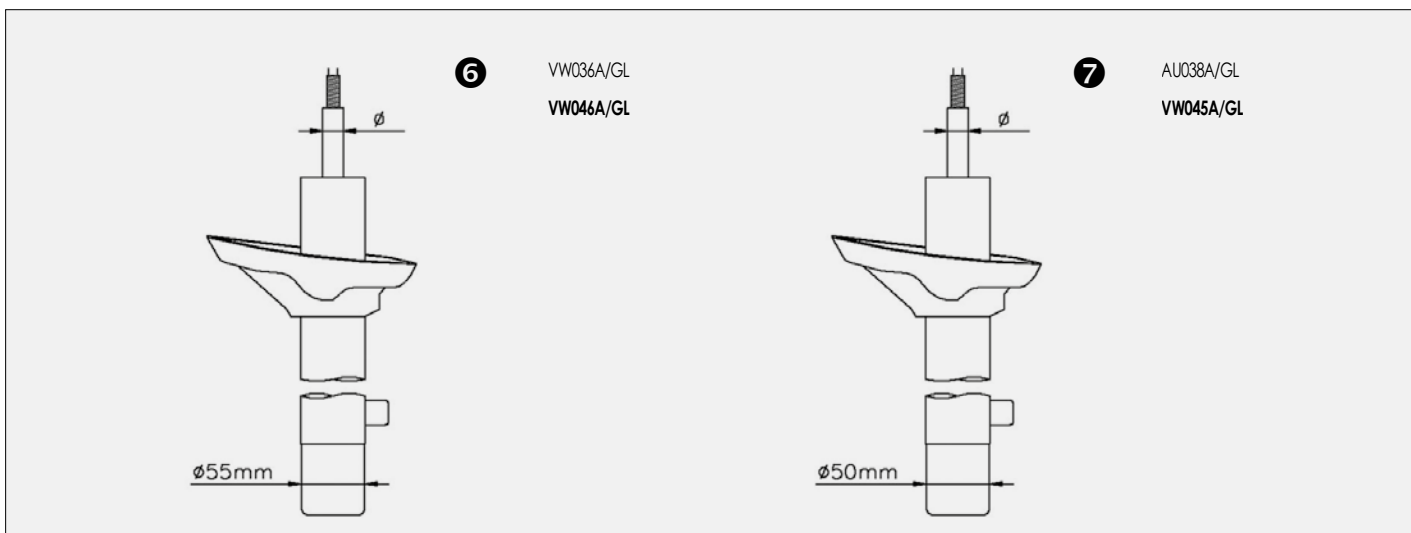
SC excl.	(5F5)	01.13 -	7		VW045A/GL	130			VW045P/GL $\frac{1}{0}$	70
			6		VW046A/GL					
ST excl.	(5F8)	08.13 -	7		VW045A/GL	130			VW045P/GL $\frac{1}{0}$	70
			6		VW046A/GL					



MII

	(KF1)	10.11 -			VW044A/GL	150			VW044P/GL $\frac{1}{0}$	60
--	-------	---------	--	--	-----------	-----	--	--	-------------------------	----

SKODA (CS)

CITIGO

		10.11 -			VW044A/GL	150			VW044P/GL $\frac{1}{0}$	60
--	--	---------	--	--	-----------	-----	--	--	-------------------------	----

FABIA

excl.	(NJ3)	08.14 -			SE016A/GL	120			SE016P/GL $\frac{1}{0}$	50
excl.	(NJ5)	10.14 -			SE016A/GL	120			SE016P/GL $\frac{1}{0}$	50

SUPERB

Assale multilink excl.	(3V3)	03.15 -	6		VW046A/GL	130			VW046P/GL $\frac{1}{0}$	70
Assale multilink excl.	(3V5)	03.15 -	6		VW046A/GL	130			VW046P/GL $\frac{1}{0}$	70

SUZUKI (J)

ALTO V

1.0	(HA25, HA35)	01.09 -							NI075P/GL $\frac{0}{0}$	50
-----	--------------	---------	--	--	--	--	--	--	-------------------------	----

SWIFT IV

1.2, 1.3 DDIS excl. 4WD	(FZ, NZ)	10.10 -			SK022AS/GL	90			SK020P/GL $\frac{1}{0}$	55
					SK022AD/GL					

OIL
GAS

OIL
GAS

TOYOTA (J)

AURIS

	(NZE18_,ZRE18_,ZWE18_)	10.12 -			TY068AS/GL TY068AD/GL		200			TY068P/GL	$\frac{1}{0}$	60
Touring sport excl. versioni D-4D,	(ADE18_,ZWE18_,ZRE18_)	07.13 -			TY068AS/GL TY068AD/GL		200					

COROLLA

	(NRE18_,ZRE17_,ZRE18_,NDE18_)	06.13 -			TY068AS/GL TY068AD/GL		200			TY068P/GL	$\frac{1}{0}$	60
excl.												

IQ

EXCL. EV	(KPJ1_,NGJ11_,KGJ1_,NUJ1_)	01.09 -			TY070AS/GL TY070AD/GL		140			TY070P/GL	$\frac{1}{0}$	50
----------	----------------------------	---------	--	--	--------------------------	--	-----	--	--	-----------	---------------	----

PRIUS

1.8 Hybrid	(ZVW3)	04.09 -			TY071AS/GL TY071AD/GL		180			TY071P/GL	$\frac{0}{0}$	110
------------	--------	---------	--	--	--------------------------	--	-----	--	--	-----------	---------------	-----

VOLKSWAGEN (D)

BEETLE

Assale rigido	(5C1)	04.11 -			AU038A/GL VW036A/GL		130				$\frac{1}{0}$	
Assale multilink	(5C1)	04.11 -			AU038A/GL VW036A/GL		130				$\frac{1}{0}$	
Assale rigido	(5C7)	12.11 -			AU038A/GL VW036A/GL		130				$\frac{1}{0}$	
Assale multilink	(5C7)	12.11 -			AU038A/GL VW036A/GL		130				$\frac{1}{0}$	

6 7	Vedi disegno/nota Volkswagen Golf a pagina 13	Siehe Volkswagen Golf Zeichnung/Anmerkung auf Seite 13
	See drawing/note Volkswagen Golf on page 13	Ver dibujo/anotación Volkswagen Golf a la página 13
	Voir plan/note Volkswagen Golf à la page 13	Ver figura/note Volkswagen Golf na página 13

CADDY III

incl. maxi excl. 4WD,	(2K_, 2C_)	08.10 - 05.15			AU038A/GL VW036A/GL		130			VW047P/GL	$\frac{1}{0}$	70
incl. maxi, 4WD excl.	(2K_, 2C_)	05.08 - 05.15			AU038A/GL VW036A/GL		130			VW048P/GL	$\frac{1}{0}$	70

CADDY IV

incl. maxi excl. 4WD,	(SA_)	05.15 -			AU038A/GL VW036A/GL		130			VW039P/GL	$\frac{1}{0}$	70
--------------------------	-------	---------	--	--	------------------------	--	-----	--	--	-----------	---------------	----

MULTIVAN T6

excl.	(SGF, SGM, SGN)	04.15 -								VW038P/GL	$\frac{0}{0}$	50
-------	-----------------	---------	--	--	--	--	--	--	--	-----------	---------------	----



		OIL	GAS				OIL	GAS		
--	--	------------	------------	--	--	--	------------	------------	--	--

VOLKSWAGEN (D)

PASSAT VI

Alltrack excl.	(365)	01.12 - 12.14			VW036A/GL		130			VW036P/GL	$\frac{1}{0}$	70
Alltrack incl.	(365)	01.12 - 12.14			VW037A/GL		130			VW037P/GL	$\frac{1}{0}$	70

PASSAT VII

excl. , Alltrack	(3G2, 3G5)	08.14 -			VW046A/GL		130					
-------------------	------------	---------	--	--	-----------	--	-----	--	--	--	--	--

TOURAN II

	(1T3)	05.10 - 05.15			VW042A/GL					VW042P/GL	$\frac{1}{0}$	80
--	-------	---------------	--	--	-----------	--	--	--	--	-----------	---------------	----

TOURAN III

assale multilink	(5T1)	09.15 -			VW046A/GL		130			VW046P/GL	$\frac{1}{0}$	70
------------------	-------	---------	--	--	-----------	--	-----	--	--	-----------	---------------	----

TYPE VI TRANSPORTER

excl.	(SG_, SF_)	04.15 -			VW038A/GL					VW038P/GL	$\frac{0}{0}$	40
-------	------------	---------	--	--	-----------	--	--	--	--	-----------	---------------	----

VOLVO (S)

V40

T2 GTDi, T4 GTDi, T4 GTDi, T4, T5, D2, D3, D4		03.12 -			VL030AS/GL		80			VL030P/GL	$\frac{1}{0}$	60
					VL030AD/GL							

ORDINI: Gli ordini devono pervenire presso la nostra sede a mezzo fax o posta elettronica. Solo in via del tutto eccezionale possono essere accettati ordini verbali, in tal caso si declina ogni responsabilità per inesattezze, incomprensioni o interpretazioni errate. Tutti gli ordini sono subordinati all'approvazione da parte dell'azienda che si riserva la facoltà di accettarli.

PREZZI: Per tutti gli ammortizzatori a catalogo fanno fede i prezzi indicati sul listino in vigore. Tutti i prezzi si intendono IVA esclusa e franco nostro stabilimento. L'azienda si riserva la facoltà di modificare i prezzi convenuti senza obbligo di preavviso. Invitiamo la gentile clientela a verificare tutte le condizioni indicate nella conferma d'ordine.

CONSEGNE: Tutti i termini di consegna del materiale ordinato, anche se indicati nella conferma d'ordine, sono da considerarsi indicativi e non impegnativi per l'azienda. I ritardi o le mancate consegne del materiale eventualmente non disponibile presso i nostri magazzini non potranno dare consenso all'annullamento dell'ordine in corso, né potranno costituire pretesto per risarcimento di danni. Eventuali deroghe alle presenti condizioni di consegna devono essere concordate ed accettate per iscritto da entrambe le parti.

CONFEZIONAMENTO: Tutto il materiale verrà consegnato adeguatamente confezionato, secondo gli standard previsti dall'azienda. Eventuali variazioni in questo senso devono essere concordate con l'ufficio commerciale e regolamentate per iscritto. Le spese di confezionamento si intendono comprese nel prezzo degli ammortizzatori.

IMBALLO: L'imballo verrà effettuato secondo gli standard in uso e fatturato al costo. Eventuali variazioni in tal senso devono essere preventivamente concordate per iscritto da entrambe le parti.

SPEDIZIONE: La merce viaggia sempre a rischio e pericolo del committente, anche se spedita in porto franco. In mancanza di precise indicazioni del committente tutto il materiale verrà spedito con il mezzo ritenuto più opportuno. La nostra responsabilità, per tutto il materiale spedito, si conclude alla consegna del medesimo al vettore. Eventuali danni, furti, manomissioni o quant'altro possa arrecare inconvenienti al committente vanno gestiti direttamente dallo stesso con il trasportatore. Il destinatario rimane comunque vincolato al pagamento totale della merce spedita. L'azienda non risponde per eventuali ritardi nelle consegne derivanti da cause di forza maggiore o da circostanze dipendenti dal vettore.

RECLAMI: Eventuali reclami, dovuti a discordanze riscontrate nella documentazione, o di qualsiasi altra natura, devono essere notificati entro e non oltre 8 giorni dalla data di ricevimento del materiale a mezzo lettera raccomandata. Fanno eccezione tutti i reclami considerati motivo di garanzia per i quali rimandiamo alla sezione "garanzia del prodotto".

PAGAMENTI: Il pagamento delle fatture deve essere fatto entro il termine prescritto ed indicato in fattura. Il mancato rispetto dei termini di pagamento comporterà l'addebito delle spese di insoluto e degli interessi di mora, calcolati in base al tasso EURIBOR maggiorato di 6 punti; renderà inoltre le altre fatture in corso, ancorché non scadute, immediatamente esigibili. Il mancato pagamento autorizza pure l'azienda a sospendere tutte le forniture con effetto immediato. I pagamenti sono validi solo se effettuati, direttamente all'azienda o a persona da noi espressamente autorizzata, secondo le disposizioni concordate con il nostro ufficio amministrativo.

CONTROVERSIE: Per qualsiasi controversia, nessuna esclusa, sarà competente il Foro di Treviso.

TUTELA DELLA PRIVACY: Tutti i dati relativi al committente, ivi compresi quelli inerenti gli ordinativi e le condizioni in uso, saranno custoditi ed elaborati, anche con sistemi informatici, per soli scopi statistici, adempimenti fiscali e di legge e per l'invio di materiale informativo o promozionale, secondo quanto stabilito dalla legge 675/96 e D.L.196/2003 in materia.

Tutte le condizioni riportate, ivi incluse quelle seguenti, relative alla garanzia del prodotto, si ritengono accettate integralmente al momento del ricevimento dell'ordine, sia esso scritto o verbale.

GARANZIA DEL PRODOTTO

L'intera gamma **TOPLINE** è offerta con una garanzia di due anni. Tale garanzia si ritiene subordinata alle condizioni, elencate di seguito, che l'acquirente è tenuto a verificare e rispettare durante l'intero periodo garantito.

CONDIZIONI DI GARANZIA: La garanzia di due anni applicata a tutti gli ammortizzatori copre esclusivamente le non conformità, verificate sugli ammortizzatori stessi, relativamente a vizi di fabbricazione e di funzionamento.

La garanzia del prodotto, in quanto tale, vale esclusivamente nei termini di sostituzione gratuita del materiale riconosciuto difettoso.

Tale garanzia inoltre si ritiene valida per il solo prodotto riconosciuto non conforme, pertanto non prevede estensioni a coppie o insiemi di ammortizzatori, anche se installati sul medesimo veicolo.

Non sussistono risarcimenti, o pretese di qualsiasi natura, ulteriori a quelle precedentemente esposte; anche qualora direttamente o indirettamente collegate alla non conformità del prodotto.

La garanzia non comprende :

- La normale usura dell'ammortizzatore.
- I danni derivanti da incidenti, di qualsivoglia natura, subiti dal veicolo.
- I danni provocati all'ammortizzatore da un montaggio scorretto o dall'impiego di attrezzature non idonee (es. stelo rovinato dalle pinze).
- I danni provocati dall'utilizzo dell'ammortizzatore su veicoli diversi da quelli per i quali è stato realizzato, in conformità a quanto riportato sullo stesso catalogo corrente.
- I danni causati da manomissioni di qualsiasi natura apportate all'ammortizzatore.
- Le non conformità dovute all'impiego dell'ammortizzatore su sistemi di sospensione speciali per i quali non è previsto il suo impiego (sospensioni autolivellanti, sospensioni regolabili elettronicamente, ecc.).
- I danni arrecati all'ammortizzatore dall'utilizzo del veicolo in competizioni automobilistiche di qualsiasi natura.
- I danni causati all'ammortizzatore dal montaggio su sospensioni con caratteristiche e componenti diversi dall'originale, quali ad esempio molle tagliate, tamponi e parapolvere modificati o eliminati, ecc.
- Eventuali montaggi abbinati a molle di assetto sportivo, eccezion fatta per le molle di assetto di nostra produzione e per i pacchetti sportivi forniti dalla casa produttrice.
- I danni arrecati da manutenzione scorretta o insufficiente del mezzo.

RICHIESTA DI GARANZIA: La richiesta di garanzia del prodotto deve essere presentata al concessionario presso il quale è stato acquistato.

Il concessionario stesso provvederà direttamente, dopo l'accertamento della non conformità, alla sostituzione del materiale difettoso.

Al concessionario dovranno essere consegnati tutti i dati indispensabili alla verifica della garanzia, e più precisamente :

- Estremi dell'acquirente o dell'officina di montaggio.
- Codice dell'articolo non conforme.
- Quantità non conforme.
- Data di acquisto e di montaggio.
- Dati di riconoscimento del veicolo.
- Condizione del veicolo al momento del montaggio.
- Descrizione dettagliata della non conformità.

Il concessionario successivamente avrà cura di trasmettere i suddetti dati all'ufficio di Controllo Qualità del produttore il quale avvierà il processo di verifica.

Dopo l'acquisizione dei dati forniti dal cliente verrà data l'autorizzazione al reso del materiale difettoso.

Il prodotto ritenuto non conforme dovrà quindi pervenire presso di noi, in porto franco, corredato di documento in conto garanzia (qualora il materiale non fosse spedito dal distributore la bolla dovrà recare come intestatario il distributore stesso).

Sarà respinto tutto il materiale spedito senza il benessere a procedere da parte dell'azienda.

Il ripristino, la sostituzione o l'accredito del prodotto in garanzia sarà fatto solo dopo l'accertamento della non conformità da parte del personale tecnico addetto al controllo qualità, nel rispetto delle condizioni sopra elencate. Lo stesso personale sarà a disposizione del cliente per ogni chiarimento in merito.

La possibilità di sostituzione immediata del materiale ritenuto non conforme, al fine di evitare il fermo del veicolo, è prerogativa esclusiva del distributore, il quale può eventualmente adottarla a sua discrezione, rimanendo tuttavia non vincolata alle condizioni generali di garanzia del prodotto.

Per conoscenza segnaliamo che tutti i reclami ed i certificati di garanzia verranno archiviati, unitamente ai dati a nostra disposizione (cliente, non conformità, riferimenti produttivi, ecc.), per disporne in qualunque momento e per verificare l'utilità di azioni correttive eventualmente necessarie su alcuni prodotti.

Tutti i dati dei clienti verranno comunque custoditi ed elaborati esclusivamente per attività informatiche e di ricerca interne all'azienda, adempimenti di legge ed eventuale invio di materiale informativo-promozionale; in conformità a quanto richiesto dalla legge 675/96 e D.L.196/2003 sulla tutela della privacy.

PURCHASE ORDERS: Orders must be forwarded to our offices by fax or e-mail. Verbal orders will be accepted only in very special conditions, in which case we shall not be held responsible for inexactness, misunderstandings or erroneous interpretation.

Orders are subject to approval by our offices who reserves the right to accept them.

PRICES: For all shock absorbers in our catalogue the prices applied are those contained in the current up to date price-lists.

All prices do not include VAT and are for goods available ex works.

We reserve the right to make changes to the prices agreed without notice. We therefore invite customers to check all conditions at the time of our order confirmation.

DELIVERY: All delivery times provided for the goods that have been ordered, even when stated in our order confirmation, should be considered approximate and are not binding to the supplier.

Any delays or failure to deliver any goods not currently available in our warehouses shall not entitle cancellation of the order in progress and give grounds for an indemnification claim.

Any variation to these delivery terms shall be agreed and accepted in writing by both parties.

PACKAGING: All goods are delivered suitably packed, according to our company's standards.

Any variations shall be agreed with our sales department and made in writing.

The cost of packaging is included in the price of the shock absorber.

PACKING: Goods are packed by our company according to our standards and invoiced according to cost.

Any variations shall be agreed writing by both parties.

DELIVERY: Goods travel always at the customer's own risk, even when delivered duty paid.

Unless specifically stated by the customer, the goods will be delivered with the means of transport we consider most appropriate.

Our liability regarding all the goods dispatched ends upon their delivery to the forwarding agent.

Any damage, theft, tampering with or any other inconveniences caused to the customer shall be handled by the latter with the forwarding agent.

The consignee shall always pay the total amount of the goods delivered.

We shall not be held responsible for any delays due to circumstances beyond our control and/or natural calamities, or other circumstances depending on the forwarding agent.

COMPLAINTS: Any complaints due to discrepancies in the documents or of any other kind, shall be notified by registered letter no later than 8 days after receipt of the goods.

This clause does not apply in the case of complaints considered warranty conditions regarding this please see the "Product warranty" section.

PAYMENTS: Invoices shall be paid within the prescribed term stated in the invoice.

Non-compliance with the terms of payment shall cause any unsettled payment expenses to be charged interest for delayed payment, calculated according to the EURIBOR rate plus 6% and due for immediate payment even if not overdue.

Any failure to settle payments authorises us to suspend all deliveries immediately.

Payments are valid only when made directly to our company or to any person authorised by the company in agreement with our administration.

DISPUTES: Disputes of any kind shall be submitted to the jurisdiction of the Court of Treviso.

PRIVACY: All data concerning customers, including any information concerning orders and terms applied, shall be stored and processed, even electronically solely for statistical purposes, for legal or fiscal requirements and for dispatching informative or promotional material as prescribed by the relevant Italian Law on Privacy.

PRODUCT WARRANTY

Our whole range of **TOPLINE** is offered with a two-year warranty.

The warranty is subject to the conditions stated below that the purchaser must check and respect for the entire warranty period.

WARRANTY CONDITIONS: The two-year warranty is applied to shock absorbers in the "improved" range and covers exclusively non-compliance assessed on the shock absorbers due to manufacturing or working defects.

Our product warranty is applied exclusively in terms of free of charge replacement goods acknowledged as being faulty.

In addition, the warranty applies in the case of a single product acknowledged as non-confirming and therefore cannot be extended to pairs or multiple shock absorbers, even when they are installed on the same vehicle.

No compensation or claims of any kind besides those aforementioned are acceptable even when directly or indirectly related to the non-conforming component.

The warranty does not include:

- Normal wear and tear of shock absorbers
- Damage caused by accidents of any kind involving the vehicle.
- Damage caused to the shock absorber by improper installation or by the use of unsuitable equipment (e.g. piston rod ruined by pincers).
- Damage caused by using the shock absorber on a vehicle other than the model the shock absorber has been made for as mentioned in our current catalogue.
- Damage caused by any kind of tampering with the shock absorber.
- Non-compliance due to the use of the shock absorber in special suspension systems to which it is not suited (self-levelling suspensions, electronically adjustable suspension, etc.).
- Damage cause to the shock absorber by the use of the vehicle in any kind of car competitions.
- Damage caused to the shock absorber by installation on suspension using features and components differing from the original, such as cut springs, modified or eliminated rebound bumpers and dust covers, etc.
- Any installation combined with sports springs, apart from our own series and from original sports kits supplied by the manufacturer.
- Damage due to improper or insufficient maintenance of the vehicle.

WARRANTY REQUEST: The product warranty request must be forwarded to the dealer where it has been purchased.

After assessing non-compliance the dealer shall replace the faulty goods immediately.

It is necessary to provide the dealer with all the information needed to check the warranty, i.e.:

- Customer or installation shop details.
- Non-conforming article part number.
- Non-conforming quantity.
- Date of purchase and installation.
- Vehicle identification data.
- Vehicle conditions at the time of installation.
- Detailed description of non-compliance.

The dealer shall then communicate the information above to the manufacturer's Quality Control Service, which initiates the control process.

On receipt of the information provided by the customer the return of the faulty goods will be authorised.

Any products considered non-conforming shall therefore be returned to us carriage paid together with a warranty delivery note (if the goods are not returned via the distributor the delivery note shall be sent with the distributor as consignee).

Any goods returned without our approval shall be rejected.

The repair, replacement of our credit note for the product under warranty shall occur only once non-compliance has been assessed by our quality control technicians in the full respect of the above-mentioned conditions.

Our staff is at customer's disposal for any explanations regarding these matters.

The possibility of immediate replacement the goods considered non-conforming in prevent stopping the vehicle, depends exclusively on the distributor who proceed at his own discretion, remaining however not bound by the product general warranty conditions. We inform you that all complaints and warranty certificates will be filed together with the information available to us (customer, non-compliance, production references, etc.) so that we can use them at any time and to assess the utility of any corrective actions required for products.

All customer data will be filed and processed only for internal information and research activities, legal or fiscal requirements and dispatch of informative and promotional material in compliance with the Italian Law concerning the safeguard of privacy.

All the aforesaid conditions are considered accepted in full upon receipt of a written or verbal order.

PARAOLIO SCOPPIATO

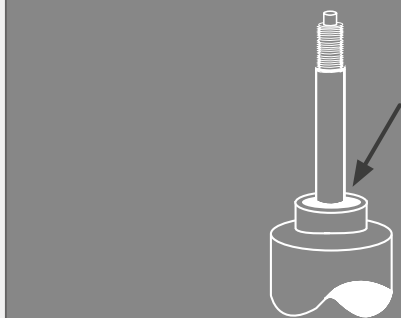

Ammortizzatore che presenta una slabbratura della guarnizione di tenuta con conseguente perdita di olio e quindi rottura dell'ammortizzatore, dovuta alla NON sostituzione del tampone di fine corsa deteriorato e quindi al non rispetto del suo corretto funzionamento come assorbitore d'urti.

A shock absorber with burring on the gasket and consequent oil leak, which would lead to the shock absorber breaking. This is caused by failure to replace the worn rubber rebound bumper, which is unable to absorb any impact.

SFONDAMENTO DI FINECORSA

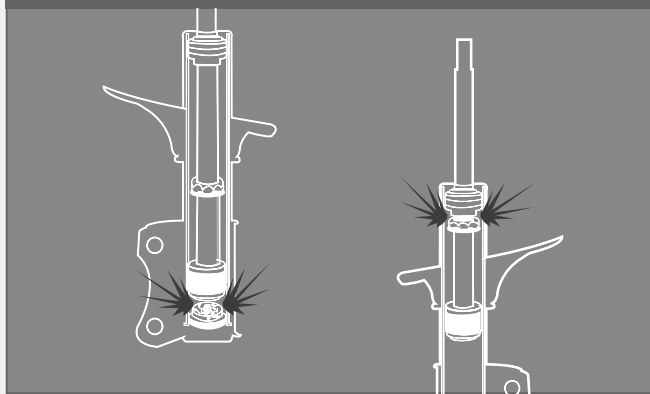

Sfondamento della valvola di fondo dell'ammortizzatore e del pistone a causa del continuo lavoro a fine corsa inferiore dell'ammortizzatore causato da percorrenza in strade dissestate e da continui dossi rompi velocità con conseguente deterioramento del tampone di fine corsa e del cedimento progressivo della molla di sospensione. Risultato perdita olio, effetto elastico e non funzionamento dell'ammortizzatore.

A smashed bottom valve and piston due to continued working of the shock absorber at the bottom, caused by uneven road surfaces or speed humps, which damage the rubber rebound bumper and gradually cause the suspension spring to give way. The result is leaking oil, reduced elastic effect and ineffective shock absorber.



PRINCIPALI CAUSE DI DANNEGGIAMENTO NON IMPUTABILI A DIFETTOSITÀ DEL PRODOTTO

PRINCIPLE DEFECTS DUE TO IMPROPER HANDLING OF PRODCUT

ROTTURA TAMPONE DI FINECORSA

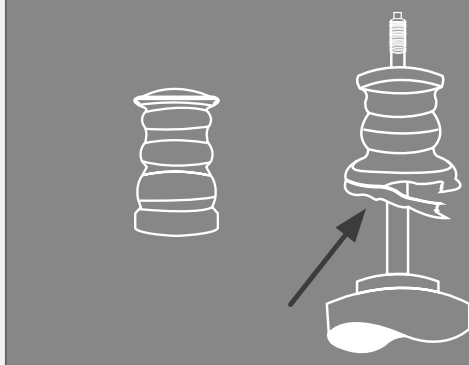

Ammortizzatore danneggiato per usura del tampone di fine corsa, dove soprattutto con il nuovo e massiccio impiego da parte dei costruttori del poliuretano microcellulare che evita in parte anche il sovraccarico del mezzo, il tampone si deteriora rapidamente sia come sfrangiatura che come rigidità con conseguente rottura dell'ammortizzatore per urti di fine corsa inferiore.

A shock absorber damaged by a worn rubber rebound bumper due to the massive use by manufacturers of microcell polyurethane to make the bumpers, which avoid part of the shock absorber overload. With excessive work the bumper deteriorates, disintegrates and becomes hard, and therefore the shock absorber breaks due to closing impact.

ROTTURA OCCHIELLI E PERNI

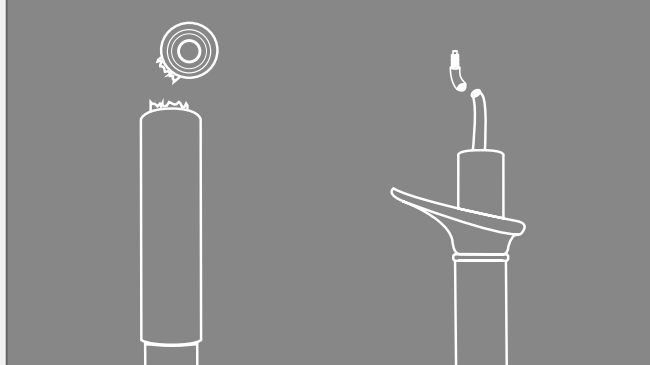

Ammortizzatore che presenta il distacco dell'occhiello (o del perno) dovuto ad un urto, o nel caso del perno, al non corretto montaggio con il giusto serraggio di coppia eseguito con le attrezzature non corrette, utilizzando la pistola pneumatica anziché la chiave dinamometrica. Il distacco dell'occhiello può avvenire anche nel caso in cui il fissaggio dell'ammortizzatore sia stato fatto ancora a veicolo sollevato, anziché con le ruote appoggiate al terreno e quindi con l'ammortizzatore nella corretta posizione di lavoro.

A shock absorber with a broken grommet (or pin), caused by a collision or incorrectly mounting the pin using the wrong tools (e.g. pneumatic screwdriver instead of a torque wrench). The grommet could also detach when the shock absorber has been mounted with the vehicle lifted off the ground and not with the wheels on the ground, which is the correct position to work the shock absorber.

FILETTATURA ROVINATA

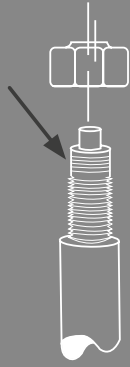

Ammortizzatore che presenta il filetto rovinato, in quanto nel montaggio non è stato utilizzato il KIT di viti corredato, bensì un dado di passo diverso da quello fornito, e soprattutto perché si è utilizzato la pistola pneumatica e non invece la chiave dinamometrica.

A shock absorber with ruined thread, due to being mounted without using the supplied screws, but just a nut with a different pitch to the one supplied. Using a pneumatic screwdriver instead of a torque wrench can also cause this damage.

AMMORTIZZATORE STORTO

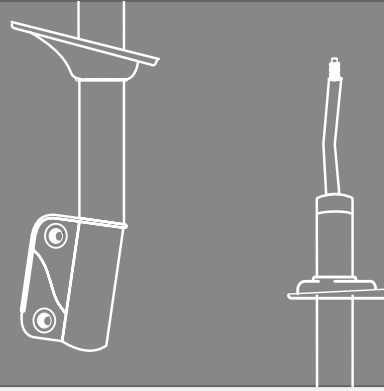

Ammortizzatore che si presenta piegato, o solo con l'albero storto, oppure il corpo piegato; normalmente questo avviene nel caso dell'albero storto, quando il veicolo urta uno scalino nella strada, mentre la piegatura del corpo dell'ammortizzatore nel caso di incidente più o meno marcato.

A shock absorber with twisted bracket, body or pin. If the piston is twisted it is normally due to impact with a kerb, while a twisted body is caused by a more serious accident.

FORI ATTACCO MODIFICATI

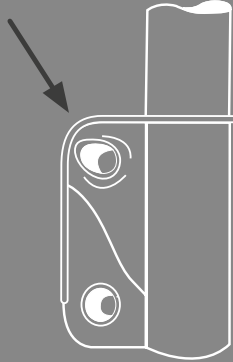

Ammortizzatore che presenta una allargatura manuale del foro di attacco al mozzo ruota in fase di controllo della geometria del veicolo, dovuto principalmente a fattori accidentali che il veicolo ha subito sulla strada, come incidenti e urti vari con conseguente spostamento degli assi di camber.

The shock absorber has a manual widening of the wheel hub attachment hole during alignment, which is caused by road accidents that cause the camber axle to move.

STELO ROVINATO E ARRUGGINITO

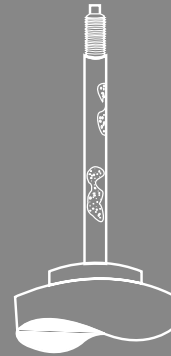

Superficie cromata dello stelo rovinata da ammaccature, botte e ruggine con conseguente perdita di olio attraverso il paraolio, difetto questo dovuto nella fase di montaggio dal non corretto fissaggio e protezione del soffietto parapolvere e del tampone di fine corsa.

The piston rod chrome-plated surface is ruined by dents, knocks and rust, with oil leaking through the oil retainer. This fault is caused by incorrectly mounting the rubber rebound bumper and the dust cover.

ALBERO ROVINATO CON LA PINZA

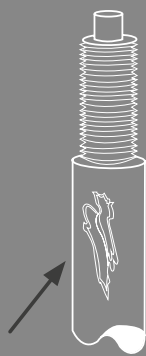

Ammortizzatore che presenta l'albero cromato con evidenti segni di graffiatura della superficie cromata, con conseguente perdita di olio e gas ogni qual volta la parte danneggiata entra nella guarnizione a tenuta di gomma. Danno causato dal non corretto impiego di utensili idonei al montaggio degli ammortizzatori.

A shock absorber with clear signs of scratching on the chrome plated surface of the piston rod, causing oil and gas leaks each time the damaged part enters the gasket. Damage caused by using incorrect tools to mount the shock absorber.

ALBERO USURATO



Ammortizzatore che presenta l'albero cromato danneggiato solo da un lato con evidente zona ovale arrugginita o quantomeno molto lucida e quindi consumata rispetto al resto della cromatura. Pistone quindi sottoposto ad un grosso carico laterale dovuto al non corretto serraggio con ruote a terra e soprattutto al non corretto camber del veicolo.

A shock absorber with the piston rod damaged on just one side, with a clear rusty or shiny oval patch and extensive wear with respect to the rest. The piston rod is subject to heavy side load, caused by incorrect mounting of the wheels on the ground and incorrect alignment.

ATTACCHI AMMORTIZZATORI

Shock absorbers end fitting - Type des fixations des amortisseurs - Befestigung der Stossdämpfer
 Esquema de anclajes - Diagrama de Montagem de Amortecedores - Bevestigingstype van de schokdemper - Monterings vejledning - Крепления амортизаторов
 ingstypen van de schokdemper - Monterings vejledning - Крепления амортизаторов



- Tipo di applicazione

- Application type
- Type de application
- Anwendung der Stossdämpfer
- Esquema de anclajes
- Esquema de Montagem
- Bevestiging van de schokdemper
- Anvendelse
- Вид применения



- Sospensione MacPherson

- Complete MacPherson strut
- Jambe de force type MacPherson
- MacPherson komplettes Federbein
- Columna de suspension
- Coluna de Suspensão MacPherson
- Complete MacPherson veerpoet
- Komplet fjederben
- Подвеска Макферсона



- Cartuccia di ricambio MacPherson

- MacPherson insert
- Cartouche type MacPherson
- MacPherson Federbeinsatz
- Cartucho accesorio para columna de suspensión
- Cartucho Substituição para Coluna Suspensão MacPherson
- MacPherson patroon
- Inlets
- Заменяемый вкладыш стойки Макферсона



- Ammortizzatore con piattello portamolla

- Shock absorber with spring seat
- Amortisseur à siège de ressort
- Stossdämpfer mit Federsitzsteller
- Amortiguador con asiento para muelle
- Amortecedor com Base para Mola
- Schokdemper met veerschotel
- Støddemper med fjeder skål
- Амортизатор с площадкой для установки пружины



- Tempo di montaggio (min) per asse

- Assembly time (min.) for the axle
- Temps de montage (min.) pour axe
- Montagezeit (Min.) jeder Achse
- Tiempo de montaje (Min.) para eje
- Tempo de Montagem (Min.) por Eixo
- Werkijd (Min.) per as
- Monterings tid (min) per aksel
- Время монтажа (минут) на мост

Occhio Eying
Oeil Auge
Anilha Anilha
Oog Øje
Отверстие

Perno Stud
Tige Tige
Stift Esparràgo
Stift Parafuso
Stift Шток
Шток

Speciale Special
Spécial Besondere
Espécial Especial
Spécial Special
Special Especial

Occhio Eying
Oeil Auge
Anilha Anilha
Oog Øje
Отверстие

Perno Stud
Tige Tige
Stift Esparràgo
Stift Parafuso
Stift Шток
Шток

Occhio Eying
Oeil Auge
Anilha Anilha
Oog Øje
Отверстие

Perno Stud
Tige Tige
Stift Esparràgo
Stift Parafuso
Stift Шток
Шток

Silentblock Barpin
Barrette Brücke
Pasador Pasador
Sinobloco Sinobloco
Pin Pin
Silentblock Втулка
Втулка

Speciale Special
Spécial Besondere
Espécial Especial
Spécial Special
Special Especial

Silentblock Barpin
Barrette Brücke
Pasador Pasador
Sinobloco Sinobloco
Pin Pin
Silentblock Втулка
Втулка

Perno Stud
Tige Tige
Stift Esparràgo
Stift Parafuso
Stift Шток
Шток

Silentblock Barpin
Barrette Brücke
Pasador Pasador
Sinobloco Sinobloco
Pin Pin
Silentblock Втулка
Втулка

Silentblock Barpin
Barrette Brücke
Pasador Pasador
Sinobloco Sinobloco
Pin Pin
Silentblock Втулка
Втулка

Occhio Eying
Oeil Auge
Anilha Anilha
Oog Øje
Отверстие

Silentblock Barpin
Barrette Brücke
Pasador Pasador
Sinobloco Sinobloco
Pin Pin
Silentblock Втулка
Втулка

Perno Stud
Tige Tige
Stift Esparràgo
Stift Parafuso
Stift Шток
Шток

Speciale Special
Spécial Besondere
Espécial Especial
Spécial Special
Special Especial

Silentblock Barpin
Barrette Brücke
Pasador Pasador
Sinobloco Sinobloco
Pin Pin
Silentblock Втулка
Втулка



















Perno Stud
Tige Tige
Stift Esparràgo
Stift Parafuso
Stift Шток
Шток



























Occhio Eying
Oeil Auge
Anilha Anilha
Oog Øje
Отверстие



















Occhio Eying
Oeil Auge
Anilha Anilha
Oog Øje
Отверстие

Silentblock Barpin
Barrette Brücke
Pasador Pasador
Sinobloco Sinobloco
Pin Pin
Silentblock Втулка
Втулка



	Tutti i modelli	All models	Tous modèles	Alle Modelle	Todos los modelos	Todos os modelos	Alle modellen	Alle modeller	Все модели
	Berlina 4 porte	Saloon 4 doors	Berline 4 portes	Limousine 4 Türen	Berlina 4 puertas	Berlina 4 portas	Berline 4-deurs	Sedan 4 Døre	Седан 4-х дверный
	Berlina 3-5 porte	Hatchback - Fastback	Berline 3-5 portes	Limousine 3-5 Türen	Berlina 3-5 puertas	Berlina 3-5 portas	Berline 3-5 deurs	Sedan 3-5 Døre	Седан 3-5 дверный
	Station wagon - Familiare	Estate - Station wagon	Break	Kombi - Variant	Familiar	Familiar - Station Wagon	Stationcar	Stationcar	Универсал
	Coupé	Coupé	Coupé	Coupé	Coupé	Coupé	Coupé	Coupe	Купе
	Cabriolet - Spider	Cabriolet, Convertible	Cabriolet, Convertible	Cabriolet	Descapotable	Descapotável	Cabriolet	Cabriolet	Кабриолет / Спайдер
	Fuoristrada	Off road	Tout terrain	Geländewagen	Todo terreno	Todo-o-Terreno	Terreinwagen	Offroad 4x4	Джип
	Van - Furgoncino	Van - Commercial	Utilitaire - Fourgonette	Kastenwagen	Furgoneta - Comercial	Veículo Comercial - Furgão	Bedrijfsvoertuig	Van	Фургон - Грузовик
	Pick-Up	Pick-Up	Pick-Up	Pick-Up	Pick-Up	Pick-Up	Pick-Up	Pickup	Комби
	Autobus - Minibus - Monovolume	Bus - Minibus - Multi purpose vehicle	Bus - Minibus - Monospace	Bus - Kleinbus - Multipurpose vehicle	Autobús - Minibús - Monovolumen	Autocarro - Furgoneta	Bus - Minibus - Monospace	Bus - Minibus	Автобус - Минибус - Многоцелевое транспортное средство
	Ambulanza	Ambulance	Ambulance	Krankenwagen	Ambulancia	Ambulância	Ziekenwagen	Ambulance	Скорая помощь
	Furgone - Camioncino	Van - Truck	Camion - Camionette	LKV - Kleinlaster	Camión ligero - Camioneta	Camião - Camioneta	Vrachtwagen - Bestelwagen	Varevogn	Фургон - Грузовик
	Autofelcio cabinato	Châssis cabine	Chassis Cab	Chassis Kabine	Chasis con cabina	Chassis de cabina	Chassis met cabine	Cab chassis/ Førerkabine	Грузопассажирский автомобиль
	Sinistra	Left hand	Gauche	Links	Izquierda	Lado esquerdo	Links	Venstre side	Правый
	Destra	Right hand	Droite	Rechts	Derecha	Lado direito	Rechts	Højre side	Левый
	Kit di protezione	Protection Kit	Kit de protection	Protection kit	Kit de protección	Jogo de Protecção	Beschermings-kit	Monterings kit	Защитный комплект
	Porte	Doors	Portes	Türen	Puertas	Portas	Deuren	Døre	Двери
	Ammortizzatore sterzo	Steering damper	Amortisseur de direction	Lenkungsdämpfer	Amortiguador de dirección	Amortecedor de Direcção	Stuurdemper	Styrdæmper	Амортизатор рулевой рейки
	Sterzo manuale	Without Power Steering	Sans direction assistée	Ohne Servolenkung	Sin dirección asistida	Sem Direcção Assistida	Met Stuurbekrachting	Ingen servostyring	Механическая рулевая рейка
	Servosterzo	Power Steering	Direction assistée	Mit Servolenkung	Dirección asistida	Direcção Assistida	Zonder stuurbekrachting	Servostyring	Рулевая рейка с гидроусилителем

									
	Cambio manuale	Manual transmission	Boîte manuelle	Schaltgetriebe	Transmisión manual	Transmissão manual	Manuele versnellingsbak	Manuel gearkasse	Механическая коробка передач
	Cambio Automatico	Automatic transmission	Boîte automatique	Automatikgetriebe	Transmisión automática	Transmissão automática	Automatische versnellingsbak	Automat gear kasse	Автоматическая коробка передач
N.D.	Standard	Normal duty	Standard	Standard Ausführung	Normal	Normal	Standaard	Normal	Стандарт
H.D.	Rinforzato	Heavy duty	Renforcé	Verstärkte Ausführung	Reforzado	Reforçado	Versterkt	Forstærket	Усиленный
	Ruota	Wheel	Roue	Rad	Rueda	Roda	Wiel	Hjul	Колесо
Susp.	Sospensione	Suspension	Suspension	Aufhängung	Suspensión	Suspensão	Ophanging	Ophæng/affjedring	Подвеска
	Sospensioni sportive	Sport suspension	Suspension sport	Sportfederung	Suspensión deportiva	Suspensão Desportiva	Sportvering	Sports- affjedring	Спортивная подвеска
	Sospensione per strade accidentate	For bad road suspension	Suspension pour routes dégradées	Federung für schlechte Straßen	Suspensión para carreteras en mal estado	Suspensão para maus pisos	Vering voor slecht wegdek	Affjedring til dårlig vej	Усиленная Подвеска
	Sospensione originale ribassata	Original lowered suspension	Suspension surbaissée	Tieferlegung	Suspensión rebajada original	Suspensão rebaixada	Verlaagde ophanging	Forsænket affjedring	Оригинальная спортивная подвеска
	Sospensione autolivellante	Self levelling suspension	Correcteur d'assiette	Niveau-Ausgleich-System	Suspensión autonivelante	Suspensão autonivelável	Ophanging met niveauregeling	Selvregulerende affjedring	Подвеска авторегулируемая
	Sospensione pneumatica	Air suspension	Suspension pneumatique	Lufffederung	Suspensión neumática	Suspensão pneumática	Pneumatische ophanging	Luftaffjedring	Пневматическая подвеска
	Sospensione idropneumatica	Hydropneumatic suspension	Suspension hydropneumatique	Hydropneumatische Aufhängung	Suspensión hidroneumática	Suspensão hidropneumática	Hydropneumatische ophanging	Hydraulisk affjedring	Гидропневматическая подвеска
	Sospensione regolabile elettronica	Electronically adjustable suspension	Suspension pilotée	Elektronisch einstellbare Federung	Suspensión ajustable electrónicamente	Suspensão regulável electronicamente	Elektronisch gestuurde ophanging	Elektronisk styret affjedring	Электронно-регулируемая подвеска
	Balestra	Leaf spring	Ressort à lames	Blattfeder	Muelle de láminas	Mola de lâminas	Bladveer	Bladfjeder	Рессора
	Molla elicoidale	Coil spring	Ressort hélicoïdale	Schraubenfeder	Muelle helicoidal	Mola helicoidal	Spiraalveer	Spiralfjeder	Спиральная пружина
	Ruote singole	Single wheel	Roues simples	Einzelbereifung	Ruedas simples	Rodas simples	Enkel wiel	Enkelthjul	Одиночные колеса
	Ruote gemelle	Twin wheels	Roues jumelées	Doppelbereifung	Ruedas dobles	Rodas duplas	Dubbele wielen	Tvillingehjul	Двойные колеса
	Asse rigido	Rigid axle	Essieu rigide	Feste Achse	Eje rígido	Eixo rígido	Vaste as	Stiv aksel	Жесткая ось
	Bracci indipendenti	Independant suspension	Suspensión indépendant	Unabhängige Aufhängung	Suspensión independiente	Suspensão independente	Onafhankelijke wielophanging	Uafhængig affjedring	Независимые рычаги
	Interasse	Wheel base distance	Empatement	Radstand	Distancia entre ejes	Distância entre eixos	Wielbasis-afstand	Hjulafstand	Межось

									
	Interasse corto	Short wheelbase	Empattement court	Kurzer Radstand	Distancia entre ejes corta	Dist. curta entre eixos	Korte wielbasis	Kort hjulafstand	Межось короткая
	Interasse medio	Medium wheelbase	Empattement moyen	Mittlerer Radstand	Distancia entre ejes media	Dist. média entre eixos	Middellange wielbasis	Medium hjulafstand	Межось средняя
	Interasse lungo	Long wheelbase	Empattement long	Langer Radstand	Distancia entre ejes larga	Dist. longa entre eixos	Lange wielbasis	Stor hjulafstand	Межось длинная
	Barra di torsione singola	2 torsion bars	Train à 2 barres de torsion	2 Torsionsstäbe	2 barras de torsión	2 barras estabilizadoras	2 torsiestangen	To torsionsstænger (snoede)	Двухторсионный стабилизатор
	Doppia barra di torsione	4 torsion bars	Train à 4 barres de torsion	4 Torsionsstäbe	4 barras de torsión	4 barras estabilizadoras	4 torsiestangen	Fire torsionsstænger (snoede)	Четырех торсионный стабилизатор
	Trazione	Front wheel drive	Traction	Vorderradantrieb	Tracción delantera	Tracção	Voorwielaan drijving	Forhjulstræk	Передний привод
	Propulsione	Rear wheel drive	Propulsion	Hinterradantrieb	Tracción trasera	Tracção traseira	Achterwielaan drijving	Baghjulstræk	Задний привод
	Asse anteriore	Front wheels	Roues Avant	Vorderachse	Tren Delantero	Dianteira	Voor	For aksel	Передняя ось
	Asse posteriore	Rear wheels	Roues Arrière	Hinterachse	Tren Trasero	Traseira	Achter	Bag aksel	Задняя ось
2WD - 4X2	2 ruote motrici	2 wheel drive	2 roues motrices	2 Radantrieb	2 ruedas motrices	Rodas Motrizes	2 aangedreven wielen	2 hjulstræk	2 ведущих колеса
4WD - 4X4	4 ruote motrici	4 wheel drive	4 roues motrices	4 Radantrieb	4 ruedas motrices	4 Rodas Motrizes	4 aangedreven wielen	4 hjulstræk	4 ведущих колеса
excl.	Escluso	Excluding	Exclus	Ausschließlich	Excluyendo	Excepto	Exclusief	Eksklusive	Исключено
incl.	Incluso	Including	Inclus	Einschließlich	Incluyendo	Inclusivé	Inclusief	Inklusive	Включено
→Ch. 000	Fino al numero di telaio	To chassis No.	Au chassis N°	Bis zur Fahrgestellnummer	Hasta el número de bastidor	Até ao Chassi N°	Tot chassin°	Til stelnummer	До номера шасси
Ch. 000→	Dal numero di telaio	From chassis No.	Du chassis N°	Ab Fahrgestellnummer	Desde el número de bastidor	A Partir do Chassi N°	Vanaf chassin°	Fra stelnummer	От номера шасси
O.E.	Riferimento originale	Original Part Number	Référence d'origine	Orignal Hinweis	Referencia original	Referência original	Origineel nummer	Originalt varenummer	Оригинальный код
ABS	Sistema antiblocco freni	Antilock Brakes System	Freins antiblocage	Antiblockier systeme	Frenos antibloqueo	ABS	Antiblokkeer remsysteem	Med ABS	Противоблокировочная система тормозов
675.021.0	Articolo nuovo immediatamente disponibile	New part number immediately available	Nouvelle référence immédiatement disponible	Neue Stossdämpfer sofort vorhanden	Nuevo número de pieza inmediatamente	disponibile Referência Nova Disponível	Nieuw nummer : direct leverbaar	Ny udviklede numre er klar til levering	Новый артикул, имеется в наличии
675.021.0	Articolo nuovo in fase di sviluppo	New part number in preparation	Nouvelle référence en préparation	Neue Hinweis in der Vorbereitung	Nuevo artículo en la preparación	Referência Nova em Desenvolvimento	Nieuw nummer in voorbereiding	Nyt varenummer under udvikling	Новый артикул в стадии разработки
<u>675.021.0</u>	Disponibile fino ad esaurimento scorte	Available until stock depleted	Disponibile jusqu'à épuisement du stock	Solange Vorrat reicht	Disponibile hasta agotar existencias	Disponível até esgotar stock	Leverbaar zolang de voorraad strekt	Leveres så længe lager haves	В наличии до окончания стока

